



**LA  
FABBRICA  
AVA**  
EXTRAORDINARY TILES

CATALOGO  
MERCHANSIDING

20  
24



# INDICE

## MERCHANDISING

Index merchandising

### ADVANCE

#### LAFABBRICA A VA

CATALOGHI  
LIBRO ARCHITETTI  
SET DA BANCO  
SCATOLA PORTA TOZZETTI  
CARTELLE AGENTI  
MOBILI ESPOSITORI  
ESPOSITORI PIASTRELLE SINGOLE  
COLLEZIONI  
PANNELLI

#### LAMBORGHINI KORIAM

#### LAMBORGHINI MAGMA

#### PARTE TECNICA

A company part of

**ITALCER**  
GROUP  
DESIGN SURFACES

# INDICE ALFABETICO

Alphabetical contents.  
Index alphabétique.  
Alphabetisches Inhaltsverzeichnis.

## A

ABSOLUTE  
AGGLOMERATE  
AMAZON  
ARDESIA  
ARTILE

## B

BORGHI ITALIANI  
BRECCIA ARGENTUM  
BRONZE AMANI  
BOLGHERI STONE

## C

CA' FOSCARI  
CALACATTA ORO  
CASTLE  
CHIANCA  
COTTO DEL CASALE

## D

DEEP STONE  
DOLOMITI

## G

GEMSTONE  
GROOVES

## H

HIGH LINE  
HONEY WOOD  
HURBAN

## I

I QUARZI  
IL CERRETO  
IMAGINE  
IMPERIAL

## L

LE MALTE

## J

JUNGLE STONE

## K

KAURI  
KORIUM

## L

LASCAUX

## M

MACCHIA ANTICA  
MAGMA

## N

NAUTILUS  
NOBLE STONE

## O

ONICE IRIDE

## P

PIERRES DES CHÂTEAUX

## R

ROYAL STONE

## S

SAHARA NOIR  
SCRATCH  
SKYLINE  
SMALL  
SPACE  
STATUARIO  
STATUARIO REALE  
STORM

## T

TRAVERTINO CLASSIC

## U

UP

# ECOSOSTENIBILITÀ

---

Eco-sustainability.  
Écodurabilité.  
Ökologische Nachhaltigkeit.

---

ITALCER PRIMA  
CLASSIFICATA AL  
SUSTAINABILITY  
AWARD 2022  
DELLE 100  
ECCELLENZE  
ITALIANE

Italcer wins  
Sustainability Award  
out of 100 top Italian companies

---



Find out more  
[gruppotalcer.it](https://gruppotalcer.it)





**Sustainability**®  
Award

**ITALCER** - WINNER OF THE  
2022 SUSTAINABILITY AWARD











ANTIVIRAL  
ANTIBACTERIAL  
ANTI POLLUTION





## CATALOGO ADVANCE

cod ITA. FADIT00  
cod DE. FADDE00  
cod FR. FADFR00  
cod EN. FADEN00

2,50 €



## FLYER

10x15 cm

cod EN. FADEN01

1 €



## TASCA PORTA MESSAGGI

21x30 cm

cod ITA. FADIT14  
cod DE. FADDE14  
cod FR. FADFR14  
cod EN. FADEN14

12 €



**VETROFANIA A4**  
21x29,7 cm

cod EN. FADEN21

10 €



**ADESIVO TONDO**  
10x10 cm

cod ITA. FADIT13

cod DE. FADDE13

cod FR. FADFR13

cod EN. FADEN13

1 €

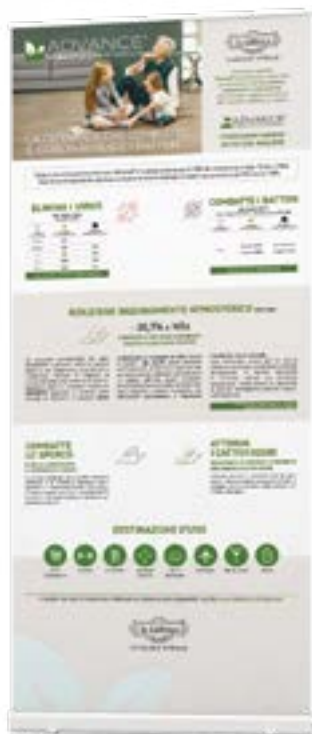

**ROLLUP MONOFACCIALE**  
85x200 cm

cod ITA. FADIT06

cod DE. FADDE06

cod FR. FADFR06

cod EN. FADEN06

45 €



**TOTEM BIFACCIALE  
ADVANCE**

80x180 cm  
cod ITA. FADIT07  
cod DE. FADDE07  
cod FR. FADFR07  
cod EN. FADEN07

165 €

**LIBRO ARCHITETTI  
FOLDER**

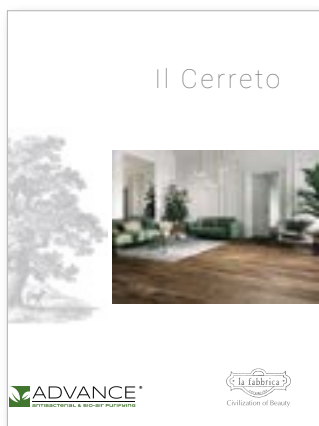

**FOLDER ADVANCE  
IL CERRETO**

cod ITA. FACEI05  
cod DE. FACED05  
cod FR. FACEF05  
cod EN. FACEE05

15 €

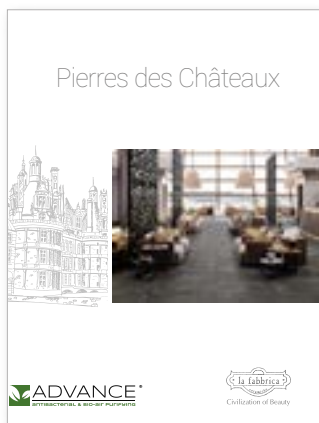

**FOLDER ADVANCE  
PIERRES DES CHATEUX**

cod ITA. FAPCI05  
cod DE. FAPCD05  
cod FR. FAPCF05  
cod EN. FAPCE05

15 €





**LA  
FABBRICA  
AVA**

EXTRAORDINARY TILES

ELENCO  
CATALOGHI  
DI LINEA

FAG2100	Agglomerate	2,50 €
CAT076	Amazon	2,50 €
FARD00	Ardesia	2,50 €
FAR2100	Artile	2,50 €
FBI2100	Borghi Italiani	2,50 €
FBLH00	Bolgheri Stone	2,00€
CAT094	Ca' Foscari	2,50 €
FCHN00	Chianca	2,50 €
FCC2100	Cotto del casale	2,50 €
CAT86	Dolomiti	2,50 €
FGMS00	Gemstone	1,80 €
FHRB121	Hurban	2,00 €
FHNW00	Honey Wood	2,70 €
CAT62N	I Quarzi	2,50 €
CAT157	Il Cerreto	2,50 €
CAT155	Imperial	2,50 €
FIMAG21	Imagine	3,00 €
FIMGN01	Brochure Imagine	3,00 €
FMLT00	Le Malte	2,00€
FJU2100	Jungle Stone	2,50 €
CAT75	Kauri	2,50 €
FKOR21	Korium	3,00 €
FMGL05	Magma	2,20 €
CAT135	Marmi	2,50 €
CAT140	Metal	7,00 €
	Noble Stone	€
FIRID21	Onice Iride	7,00 €
FPC2100	Pierres des Chateaux	2,50 €
CAT082	Skyline	3,00 €
FSML00	Small	2,60 €
CAT106	Space	2,50 €
G99340	Sostenibilità	8,00 €
FUP000	UP	2,60 €



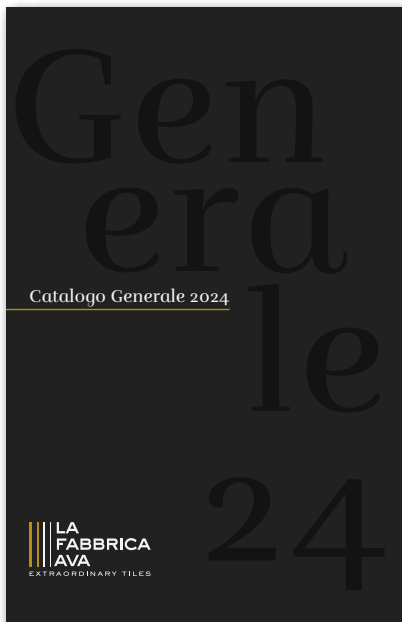

F99087

9€

**CATALOGO GENERALE  
ITALIA 2024**  
GENERAL CATALOGUE 2024

**CATALOGO OUTDOOR 2023**  
disponibile in versione pdf

OUTDOOR CATALOGUE 2023  
available in PDF

G99340

8€

**CATALOGO SOSTENIBILITA'  
2023**

F99088

9€

**CATALOGO GENERALE  
ESTERO 2024**  
GENERAL CATALOGUE  
WITH PRICES RESERVED  
TO FOREIGN MARKETS 2024



F99010

7,2€

**CATALOGO OUTDOOR 2022**  
OUTDOOR CATALOGUE



F99029

14€

**BOX PORTA CATALOGHI**

LA FABBRICA AVA

ELENCO  
LIBRO  
ARCHITETTI



FAG0105	Agglomerate	20 €
TOZ76	Amazon	30 €
TOZ137F	Ardesia	30 €
FAR0105	Artile	15 €
TOZ092	Blu Evolution	25 €
TOZ092F	Blu Evolution 20mm	20 €
FBLH03	Bolgheri Stone	12 €
FCAF04	Ca' Foscari	15 €
TOZ094F	Ca' Foscari 20mm	20 €
TOZ86F	Dolomiti 20mm	20 €
FHRB105	Hurban	20 €
FCER105	Il Cerreto	15 €
FIM0105	Imperial	15 €
FGMS03	Gemstone	11 €
FHNW03	Honey Wood	20 €
FJUN105	Jungle stone	11 €
TOZ75	Kauri	25 €
FKOR105	Korium	100 €
TOZ140A	Metal	40 €
FNBS03	Noble Stone	12 €
FPC0105	Pierres des Chateaux	15 €
TOZ149A	Scratch	35 €
FSML39	Small	16 €
TOZ117	Storm	25 €
FUP004	Up	75 €

## FOLDER

CUT TILES SAMPLE BOOK WITH CARDS



FMAR105

75€

**FOLDER MARMO E PIETRA 1** 31x48 cm  
27 tozzetti formato cm 8x8 - sp 6 mm - 27 tile cuts, size cm 8x8 - thk 6 mm

FMAR205

65€

**FOLDER MARMO E PIETRA 2** 31x48 cm  
19 tozzetti formato cm 8x8 - sp 6 mm - 19 tile cuts, size cm 8x8 - thk 6 mm

FMAT105

70€

**FOLDER MATERICO E DESIGN** 31x48 cm  
22 tozzetti formato cm 8x8 - sp 6 mm - 22 tile cuts, size cm 8x8 - thk 6 mm

**FINO AD ESAURIMENTO SCORTE**  
AVAILABILITY LIMITED IN STOCKS

### MARMO E PIETRA 1

27 TOZZETTI CM 8x8 SP MM 6

AESTHETICA HEGEL NAT e LAP  
AESTHETICA WILDE NAT e LAP  
NAUTILUS LAP  
ONICE SMERALDO LAP  
PORTORO LAP  
AZUL MACUBA NAT e LAP  
LASA NAT e LAP  
ONICE SERPENTINO LAP  
TRAVERTINO CLASSIC NAT e LAP  
WHITE MACAUBA LAP  
STATUARIO REALE NAT e LAP  
CALACATTA NAT e LAP  
STATUARIO NAT e LAP  
STATUARIO SPLENDEnte NAT e LAP  
CALACATTA ORO NAT e LAP  
MACCHIA ANTICA NAT e LAP

### MARMO E PIETRA 2

19 TOZZETTI CM 8x8 SP MM 6

BARDIGLIO CENERE NAT e LAP  
BRONZE AMANI LAP  
COPACABANA DUKE NAT e LAP  
COPACABANA EMPEROR NAT e LAP  
COPACABANA PRINCESS NAT e LAP  
CREMA MARFIL NAT e LAP  
NERO BELVEDERE LAP  
TAJ MAHAL LAP  
BRECCIA ARGENTUM NAT e LAP  
ARDESIA NAT  
C-STONE NAT  
PIRENEI NAT  
TORTOISE NAT

### MATERICO E DESIGN

22 TOZZETTI CM 8x8 SP MM 6

ABSOLUTE BLACK NAT e LAP  
ABSOLUTE WHITE NAT e LAP  
DISTRICT NERO NAT  
DISTRICT GRIGIO NAT  
DISTRICT BIANCO NAT  
DISTRICT TORTORA NAT  
METAL BLADE NAT  
METAL CORTEN NAT  
METAL GREIGE NAT  
METAL PEARL NAT  
SKYLINE ANTRACITE NAT  
SKYLINE FUMO NAT  
SKYLINE GHIACCIO NAT  
SKYLINE BEIGE NAT  
SCRATCH MOONLIGHT NAT  
SCRATCH SUPERLUNA NAT  
SCRATCH ECLIPSE NAT  
SCRATCH MILKY WAY NAT  
SCRATCH LIGHT GRAFFITI NAT  
SCRATCH DARK GRAFFITI NAT

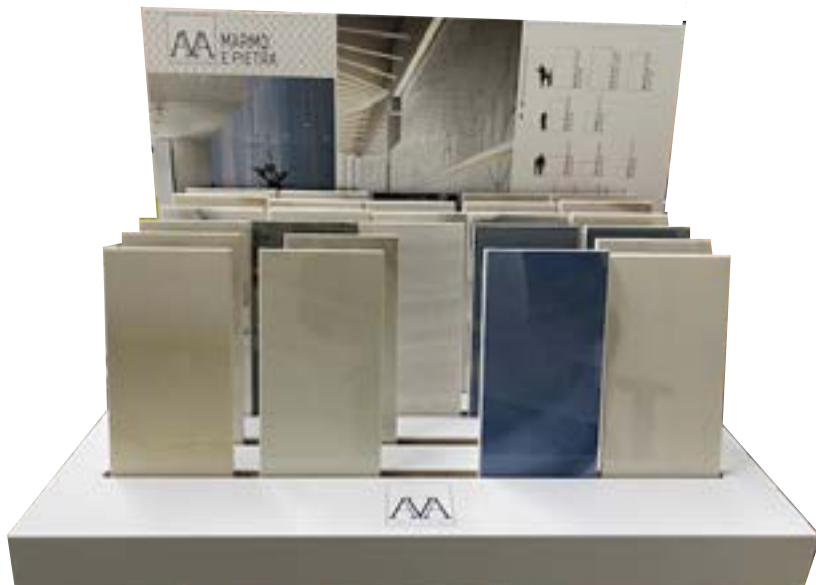

## SET DA BANCO 6 MM

### MARMO E PIETRA 1

Set contenente tozzetti sp 6 mm - Max 30 pz cm 8x16  
Set containing tile cuts thk 6 mm - Max 30 pcs cm 8x16

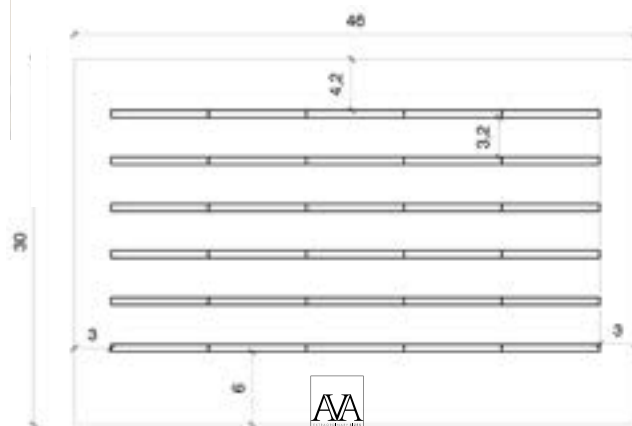

FMAR126

## 80€ MARMO E PIETRA 1

27 TOZZETTI 6 mm

AESTHETICA HEGEL NAT e LAP  
AESTHETICA WILDE NAT e LAP  
NAUTILUS LAP  
ONICE SMERALDO LAP  
PORTORO LAP  
AZUL MACUBA NAT e LAP  
LASA NAT e LAP  
ONICE SERPENTINO LAP  
TRAVERTINO CLASSIC NAT e LAP  
WHITE MACAUBA LAP  
STATUARIO REALE NAT e LAP  
CALACATTA NAT e LAP  
STATUARIO NAT e LAP  
STATUARIO SPLENDEnte NAT e LAP  
CALACATTA ORO NAT e LAP  
MACCHIA ANTICA NAT e LAP

**FINO AD ESAURIMENTO SCORTE**  
*AVAILABILITY LIMITED IN STOCKS*



**SCATOLA DA BANCO 6 MM**

**MARMO E PIETRA  
 MATERICO E DESIGN**

Scatola contenente tozzetti sp 6 mm 10x20 cm  
 Set containing tile cuts thk 6 mm - 10x20

**NUOVO STRUMENTO**

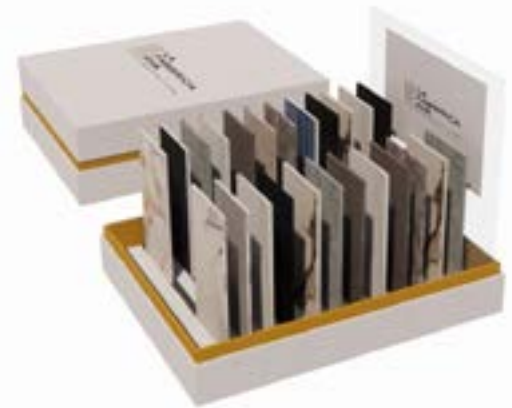

FMAR08

**140€  
 MARMO E PIETRA**

30 TOZZETTI 6 mm

- AESTHETICA HEGEL LAP
- AESTHETICA WILDE LAP
- BRECCIA ARGENTUM NAT e LAP
- BRONZE AMANI LAP
- CALACATTA NAT e LAP
- CALACATTA ORO NAT e LAP
- GEMSTONE 4 przzi LAP
- LASA NAT
- MACCHIA ANTICA NAT e LAP
- NAUTILUS LAP
- ONICE IRIDE 6 pezzi LAP
- TRAVERTINO CLASSIC NAT
- STATUARIO REALE NAT e LAP
- STATUARIO NAT e LAP
- STATUARIO SPLENDEnte NAT e LAP

FMAT07

**100€  
 MATERICO E DESIGN**

24 TOZZETTI 6 mm

- ABSOLUTE BLACK NAT e LAP
- ABSOLUTE WHITE NAT e LAP
- HURBAN 6 pezzi NAT
- METAL BLADE NAT
- METAL CORTEN NAT
- METAL GREIGE NAT
- METAL PEARL NAT
- NOBLE STONE NAT 5 COLORI**
- SKYLINE ANTRACITE NAT
- SKYLINE FUMO NAT
- SKYLINE GHIACCIO NAT
- SKYLINE BEIGE NAT
- SCRATCH MOONLIGHT NAT
- SCRATCH SUPERLUNA NAT
- SCRATCH ECLIPSE NAT
- SCRATCH MILKY WAY NAT
- SCRATCH LIGHT GRAFFITI NAT
- SCRATCH DARK GRAFFITI NAT

FNBS15

**Kit 5 colori Noble Stone**

tozzetti sp 6 mm 10x20 cm  
 cuts thk 6 mm - 10x20

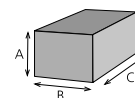

**Espositore**  
 Display

A 12 cm

B 28 cm

C 41 cm



**VALIGIA PORTA  
 TOZZETTI 6MM**

**MARMO E PIETRA  
 MATERICO E DESIGN**

Set contenente tozzetti sp 6 mm 10x20 cm  
 Set containing tile cuts thk 6 mm - 10x20 cm  
 DIMENSIONI SCATOLA CHIUSA 11x29x45 cm

**NUOVO STRUMENTO**

la scatola può avere 3 posizioni di utilizzo

FNBS15

**Kit 5 colori Noble Stone**

tozzetti sp 6 mm 10x20 cm  
 cuts thk 6 mm - 10x20

FMAR07

**190€  
 MARMO E PIETRA**

30 TOZZETTI 6 mm

- AESTHETICA HEGEL LAP
- AESTHETICA WILDE LAP
- BRECCIA ARGENTUM NAT e LAP
- BRONZE AMANI LAP
- CALACATTA NAT e LAP
- CALACATTA ORO NAT e LAP
- GEMSTONE 4 COLORI LAP
- LASA NAT
- MACCHIA ANTICA NAT e LAP
- NAUTILUS LAP
- ONICE IRIDE 6 COLORI LAP
- TRAVERTINO CLASSIC NAT
- STATUARIO REALE NAT e LAP
- STATUARIO NAT e LAP
- STATUARIO SPLENDEnte NAT e LAP

FMAT06

**150€  
 MATERICO E DESIGN**

24 TOZZETTI 6 mm

- ABSOLUTE BLACK NAT e LAP
- ABSOLUTE WHITE NAT e LAP
- HURBAN 6 COLORI NAT
- METAL BLADE NAT
- METAL CORTEN NAT
- METAL GREIGE NAT
- METAL PEARL NAT
- NOBLE STONE NAT 5 COLORI**
- SKYLINE ANTRACITE NAT
- SKYLINE FUMO NAT
- SKYLINE GHIACCIO NAT
- SKYLINE BEIGE NAT
- SCRATCH MOONLIGHT NAT
- SCRATCH SUPERLUNA NAT
- SCRATCH ECLIPSE NAT
- SCRATCH MILKY WAY NAT
- SCRATCH LIGHT GRAFFITI NAT
- SCRATCH DARK GRAFFITI NAT

VISTA FRONTALE  
 chiusa / aperta

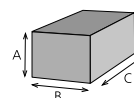

Espositore  
 Display

A 11 cm

B 29 cm

C 45 cm

## CODICI GENERICI

VALIL

**70€** prezzo comprensivo anche del posato

the price includes laid tiles

**CARTELLE AGENTI 60x60**

**2 ANTE**

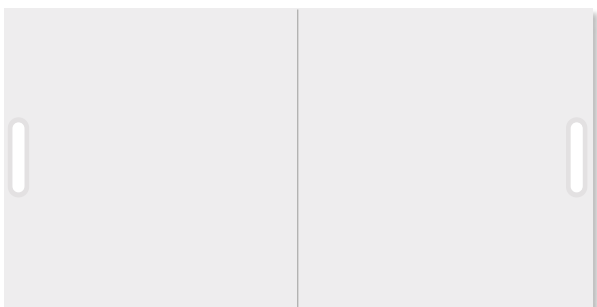

VALIF

**64€** prezzo comprensivo anche del posato

the price includes laid tiles

**CARTELLE AGENTI 80x80**

**2 ANTE**

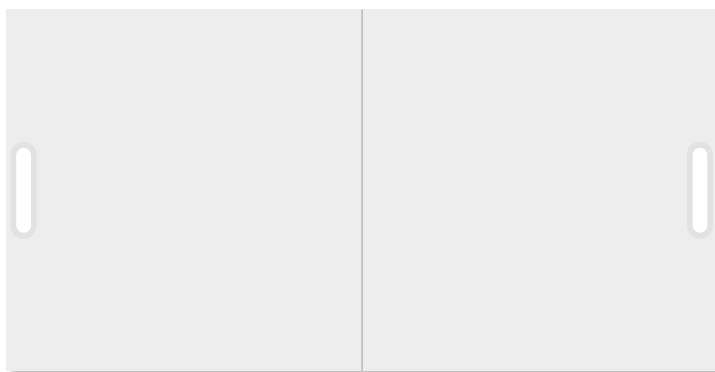

VALIH

**70€** prezzo comprensivo anche del posato

the price includes laid tiles

**VALIGIA AGENTI 30x60**

**4 VASSOI**





## CODICI GENERICI

VALID

**70€** prezzo comprensivo anche del posato  
the price includes laid tiles

**CARTELLE AGENTI 20x120**  
**2 ANTE**

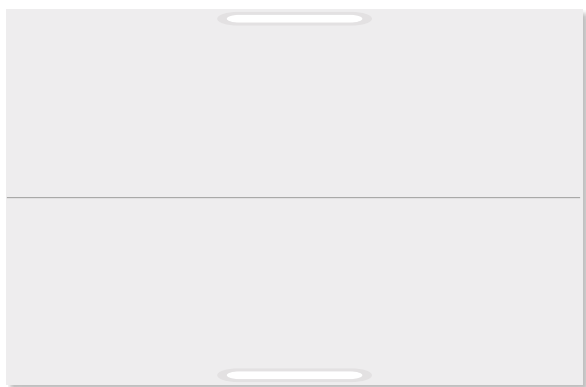

VALII

**70€** prezzo comprensivo anche del posato  
the price includes laid tiles

**CARTELLE AGENTI 30x120**  
**3 ANTE**



VALIG

**70€** prezzo comprensivo anche del posato  
the price includes laid tiles

**CARTELLE AGENTI 60x120**  
**2 ANTE**

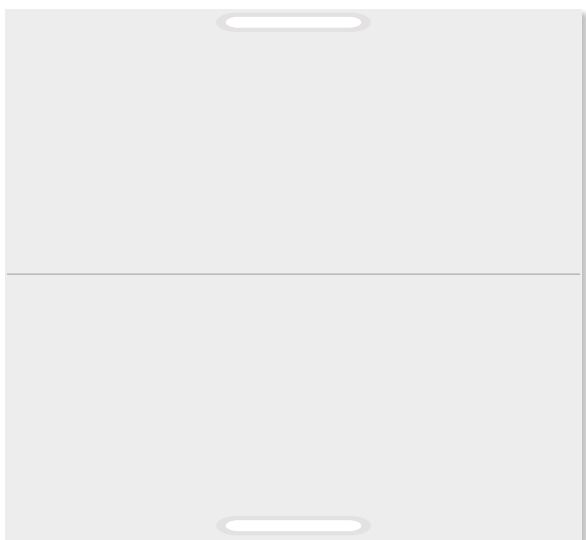



FBAS407

70€

**BASE PIANA 12 ALLOGGI SX e DX**

Espositore sinistro e destro per piastrelle/lastre singole contenente fino a 12 pz (sp da 6 a 10 mm). Formato massimo 60x120

Left and right display for single tiles/slabs. It contains up to 12 pieces (thk from 6 mm to 10 mm). Maximum size 60x120

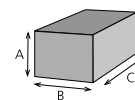
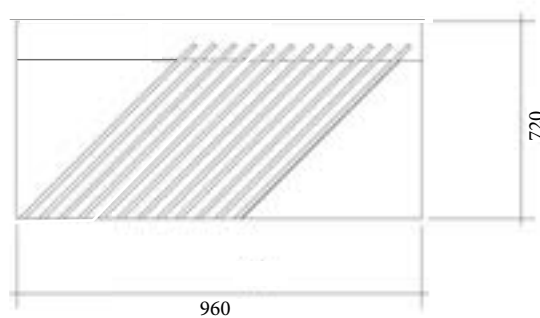
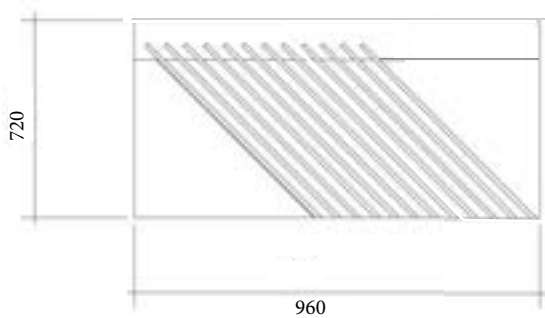
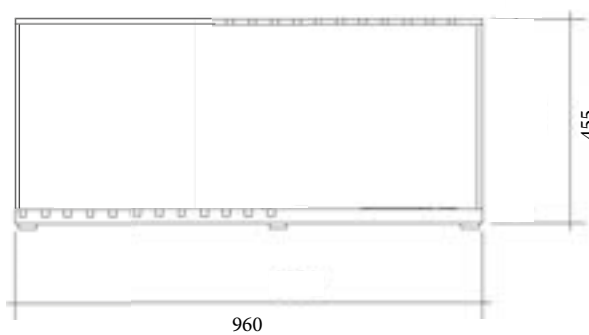
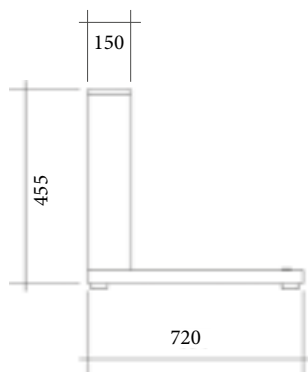

Espositore imballato vuoto  
Packaged display (empty)

A 7,5cm

B 110cm

C 68cm

Peso/Weight 26,5  
solo espositore



**FINO AD ESAURIMENTO SCORTE**  
 AVAILABILITY LIMITED IN STOCKS

FBAS107

**30€**

### CULLA OUTDOOR

Culla outdoor in metallo verniciata

Outdoor display in painted metal

max 6 pz

formato 40x120 - sp. 20mm

Peso / Weight 3 kg

Outdoor 

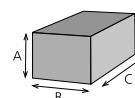

Espositore imballato (vuoto)  
 Packaged display (empty)

A 80 cm

B 120 cm

C 70 cm

Peso/Weight

FBAS207

**40€**

### CULLA OUTDOOR

Culla outdoor in metallo verniciata

Outdoor display in painted metal

max 6 pz

formati 60x60, 80x80, 60x100, 100x100

sp. 20mm

Peso / Weight 5,3 kg

Outdoor 

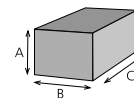

Espositore imballato (vuoto)  
 Packaged display (empty)

A 80 cm

B 120 cm

C 80 cm

Peso/Weight



FESP11

350€

**ESPOSITORE AD A**  
BIFACCIALE 130x140

Expositor  
double - sided 130x140

Outdoor ☀️



FESP12

300€

**ESPOSITORE**  
MONOFACCIALE 130x140

Expositor  
single - sided 130x140

Outdoor ☀️

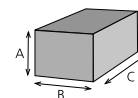

Espositore imballato (vuoto)  
*Packaged display (empty)*

A 15 cm

B 141 cm

C 151 cm

Peso/Weight



Outdoor ☀️



Abbinabile alle collezioni  
Can be combined with collections

FCAF03

**400€**

**CA'FOSCARI** 120x100 cm.

FCHN33

**450€**

**CHIANCA** 120x100 cm.

FPC08

**400€**

**PIERRES DES CHATEAUX**  
120x100 cm.

**FINO AD ESAURIMENTO SCORTE**  
*AVAILABILITY LIMITED IN STOCKS*



FHRB01

**440€**

**ESPOSITORE OUTDOOR**  
**HURBAN + kit outdoor + banner**

220x100 cm.

- 1 PZ 100x100 DECORO QUEENS BEIGE 20 mm
- 1 PZ 100x100 WHITE NAT 20 mm
- 4 PZ 20x20 OCRA NAT 20 mm
- AVIO NAT 20 mm
- GRAY NAT 20 mm
- GRAPHITE NAT 20 mm

Realizzato solo per Hurban  
Made only for Hurban

Outdoor ☀️

**FINO AD ESAURIMENTO SCORTE**  
*AVAILABILITY LIMITED IN STOCKS*



FESL13

390€

## TOTEM LASTRE

**Totem centrosala singolo contenente 2 lastre 120x280**

**Il prezzo si intende senza lastre**

**Non ne viene fatta scorta a magazzino ,  
viene disponibile dopo 45 gg dall' ordine .**

Totem central unit containing 2 sheets 120x280. The price does not include the sheets. No stock is kept in the warehouse; it becomes available 45 days after ordering.

**DISPONIBILI IN 45 GG LAVORATIVI**

*AVAILABLE IN 45 WORKING DAYS*

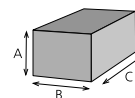

Espositore imballato (vuoto)  
*Packaged display (empty)*

A 150 cm

B 54 cm

C 124 cm

Peso/Weight



FPED160

80€

**PEDANA 160x160**

per 4 pz 80x80 sp 6 mm - sp 9 mm  
4 pcs 80x80 thk 6 mm - thk 9 mm

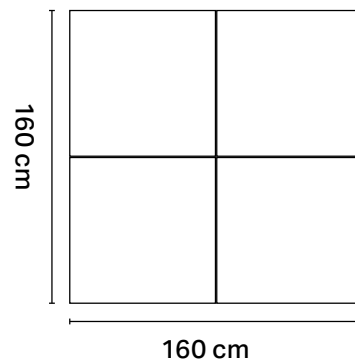

FPED120

65€

**PEDANA 120x120**

Disponibile solo su richiesta  
Available only on request.

per 2 pz 60x120 sp 6 mm - sp 9 mm  
2 pcs 60x120 thk 6 mm - thk 9 mm

per 4 pz 60x60 sp 6 mm - sp 9 mm  
4 pcs 60x60 thk 6 mm - thk 9 mm

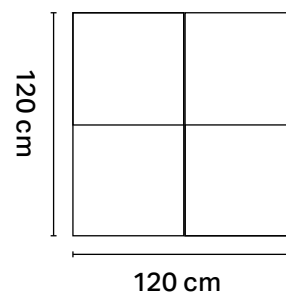
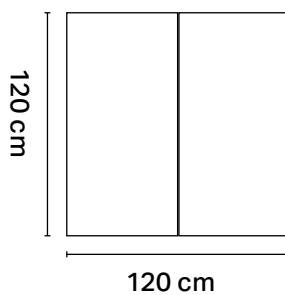



F99037

**23€**  
**FOREX DI AGGIORNAMENTO  
PER MOBILE FITA08**  
Update Banner

128cm x 54 cm

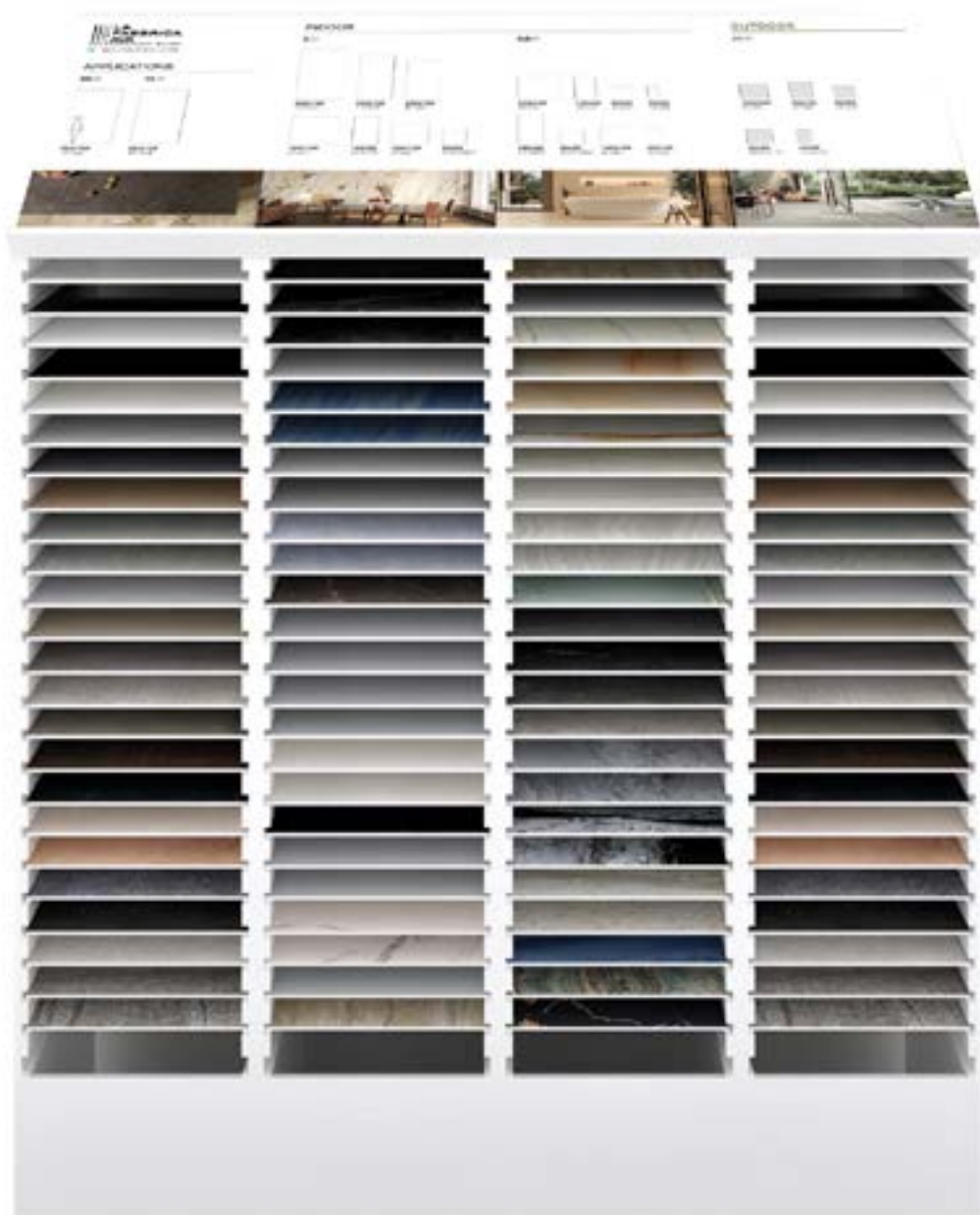

FITA08

**500€**  
**MOBILE 4 COLONNE  
FRAME 30x30**

**FINO AD ESAURIMENTO SCORTE**  
AVAILABILITY LIMITED IN STOCKS

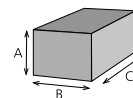

Espositore imballato (vuoto)  
Packaged display (empty)

A 80 cm

B 80 cm

C 160 cm

Peso/Weight



FKIT02

460€

## NUOVO KIT PER MOBILE FITA08

KIT TILES  
69 PZ CM 29,7x29,7-

### NUOVO KIT SOLO 6mm

AESTHETICA HEGEL LAP  
AESTHETICA WILDE LAP  
BRECCIA ARGENTUM NAT e LAP  
BRONZE AMANI  
BOLGHERI STONE LAP 4 COLORI LAP  
CALACATTA NAT e LAP  
CALACATTA ORO NAT e LAP  
GEMSTONE 4 COLORI LAP  
HONEYWOOD 6 COLORI NAT  
MACCHIA ANTICA NAT e LAP  
NAUTILUS LAP  
NOBLE STONE 5 COLORI  
ONICE IRIDE 6 COLORI LAP  
TRAVERTINO CLASSIC NAT  
TRAVERTINO CLASSIC LAP  
STATUARIO REALE NAT e LAP  
STATUARIO NAT e LAP

ABSOLUTE BLACK NAT e LAP  
ABSOLUTE WHITE NAT e LAP  
HURBAN 6 COLORI NAT  
LE MALTE 6 COLORI  
METAL BLADE NAT  
METAL CORTEN NAT  
METAL GREIGE NAT  
METAL PEARL NAT  
SCRATCH MOONLIGHT NAT  
SCRATCH SUPERLUNA NAT  
SCRATCH ECLIPSE NAT  
SCRATCH MILKY WAY NAT  
SCRATCH LIGHT GRAFFITI NAT  
SCRATCH DARK GRAFFITI NAT  
SAHARA NOIR LAP

FKIT03

160€

## AGGIORNAMENTO PER KIT FKIT01

KIT PIASTRELLE MOBILE FITA08  
CM 29,7x29,7

### Aggiornamento con novità Cersaie 2023 per FKIT01 6mm

BOLGHERI STONE LAP 4 COLORI LAP  
HONEYWOOD 6 COLORI NAT  
HURBAN 5 COLORI NAT  
LE MALTE 7 COLORI  
NOBLE STONE 5 COLORI NAT

### Update with news for Cersaie 2023 for FKIT01 6mm

BOLGHERI STONE LAP 4 COLORI LAP  
HONEYWOOD 6 COLORI NAT  
HURBAN 6 COLORI NAT  
LE MALTE 6 COLORI  
NOBLE STONE 5 COLORI NAT

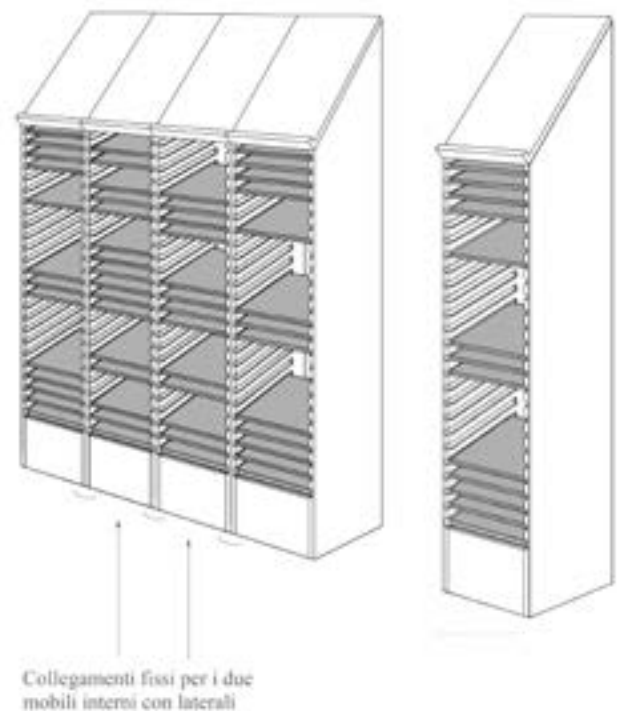
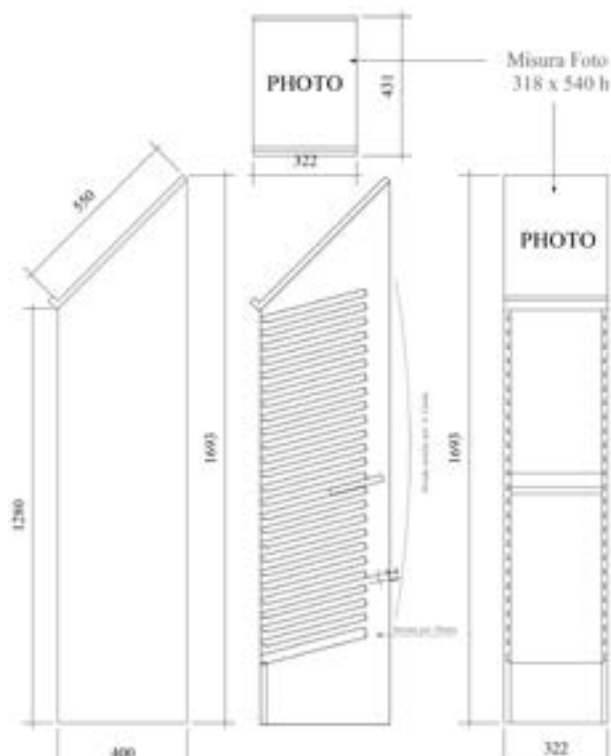



FESP13

190€

**NEW ESPOSITORE A TIRO 60x120  
SIA DX CHE SX**

Espositore scorrevole monofacciale per 10 lastre 60x120  
Exhibitor accommodating 10 single-side sliding slabs 60x120

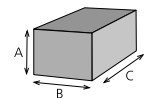
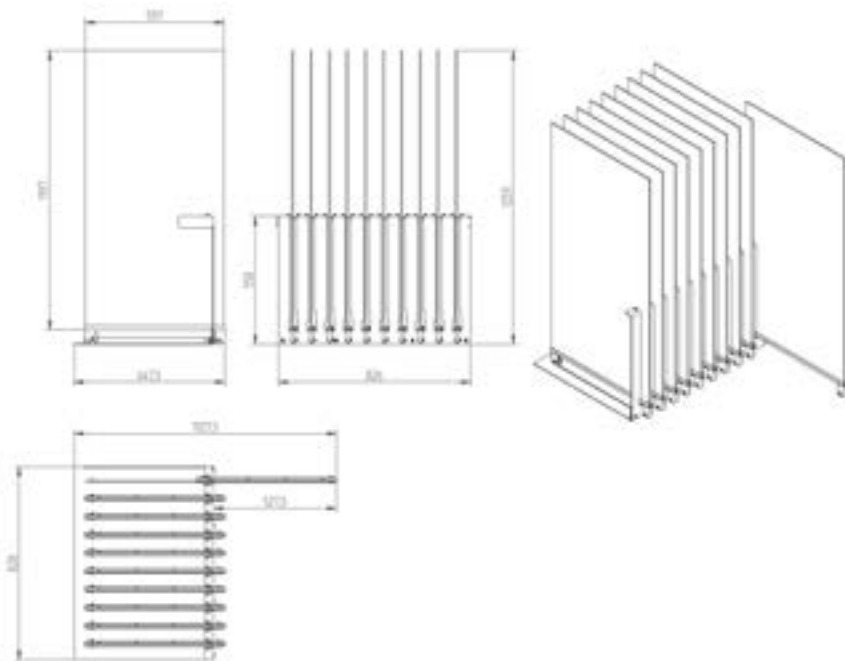

Espositore imballato (vuoto)  
Packaged display (empty)

A 14 cm

B 60 cm

C 101 cm

Peso/Weight



FESP02

**180€****ESPOSITORE A TIRO 100x100**

Espositore scorrevole monofacciale per 6 lastre 100x100  
 Exhibitor accommodating 6 single-side sliding slabs 100x100

**FINO AD ESAURIMENTO SCORTE**

AVAILABILITY LIMITED IN STOCKS

da sostituire con twister 100x100

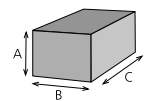
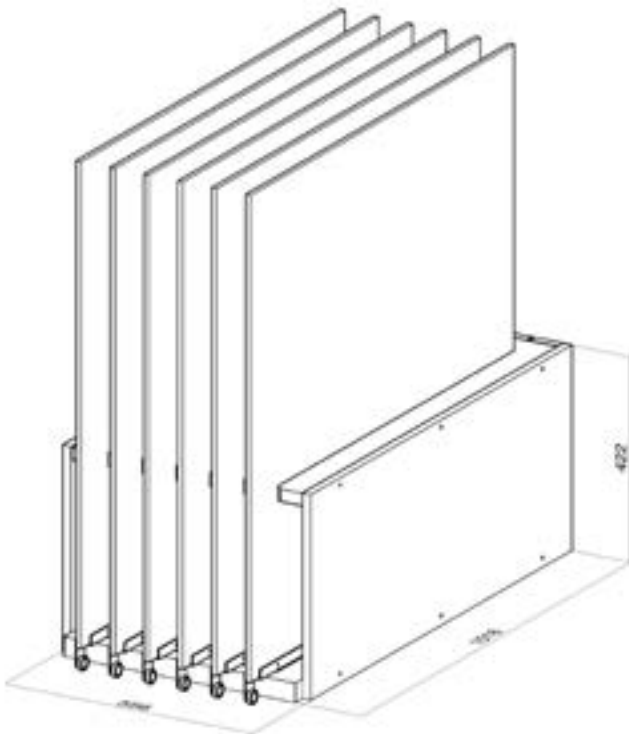

Espositore imballato (vuoto)  
 Packaged display (empty)

A 12 cm

B 65 cm

C 88 cm

Peso/Weight

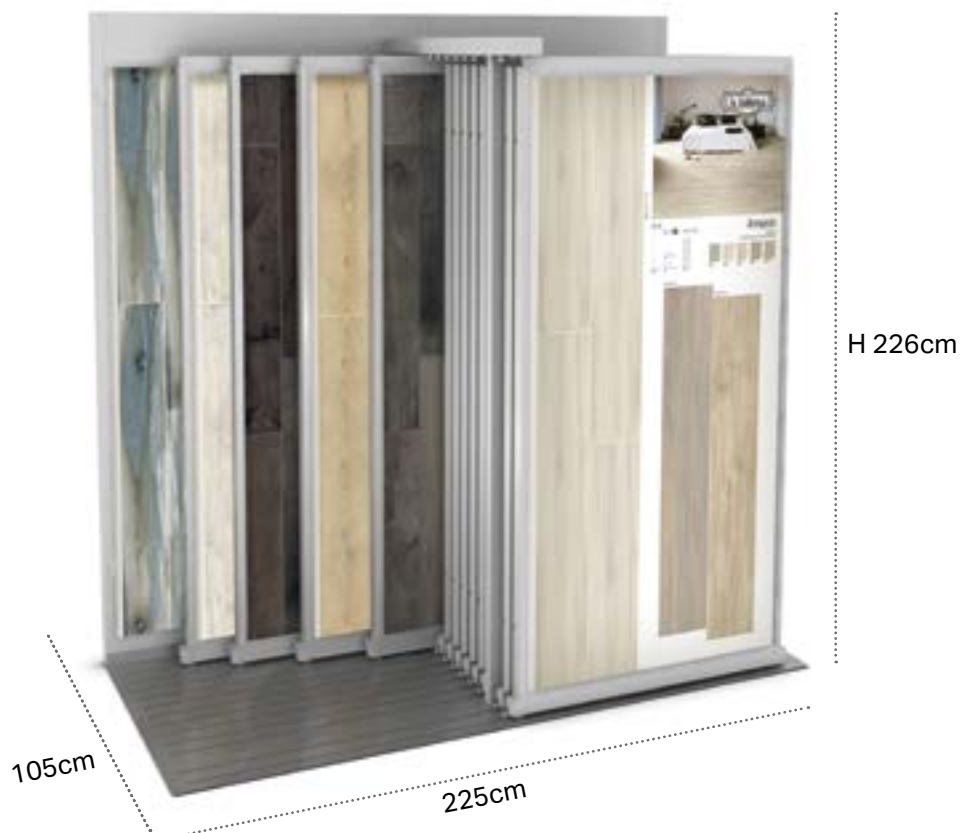

FESP03

**2000€**  
**ESPOSITORE 100x200**

Espositore contenente 14 pannelli (2 fissi)  
I pannelli misurano 100x200 cm  
Impianto di illuminazione non incluso, opzionale

Display contains 14 panels (2 fixed)  
The panels measure 100x200 cm  
Lighting system not included, optional

**DISPONIBILI IN 45 GG LAVORATIVI**  
*AVAILABLE IN 45 WORKING DAYS*

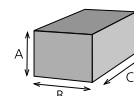

Espositore imballato (vuoto)  
*Packaged display (empty)*

A 85 cm

B 120 cm

C 240 cm

Peso/Weight 490 kg



FESP04

**3800€****ESPOSITORE A TIRO**

Espositore contenente 27 pannelli (3 fissi)  
 I pannelli misurano 100x200 cm  
 Impianto di illuminazione non incluso,  
 opzionale

Exhibitor contains 27 panels (3 fixed)  
 The panels measure 100x200 cm  
 Lighting system not included,  
 optional

**DISPONIBILI IN 45 GG LAVORATIVI**

AVAILABLE IN 45 WORKING DAYS

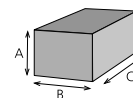

Espositore imballato (vuoto)  
 Packaged display (empty)

A 140 cm

B 120 cm

C 355 cm

Peso/Weight 940 kg



FESP108

**950€**

### **TWISTER 120x120**

Espositori a 5 carrelli bifacciali scorrevoli e girevoli a 180°

Richiedere il pannello F00120  
con l'utilizzo di piastrelle spessore 6mm  
o da abbinare ai pannelli posati

Exhibitors with 5 double-sided sliding and 180° rotating trolleys  
Request panel F00120  
with the use of 6mm thick tiles  
or to combine with the laid panels

### **FINO AD ESAURIMENTO SCORTE**

*AVAILABILITY LIMITED IN STOCKS*

*da sostituire con*



FESL12

**900€**

### **TWISTER 120x120**

**6mm e 12 mm**

**ESPOSITORE BIFACCIALE**

**5 CARRELLI ESTRAIBILI E GIREVOLI**

**10 LASTRE/SLABS**

**120x120 6mm/12mm**

Espositore contenente 10 lastre 120x120 sp  
6 mm/12mm

estraibili e girevoli. Senza pannello retrostante.

Exhibitor contains 10 slabs 120x120

sp 6 mm/12mm

extractable and revolving slabs.

Without wood Panels

Se si vuole esporre il 6mm bisogna utilizzare le viti nel sacchetto (cerchiato in rosso) e non quelle già montate sulle manine che tengono ferme le piastrelle.

If you want to show the 6mm you have to use the screws in the bag (circled in red) and not the ones already installed on the small handles that hold the tiles in place.



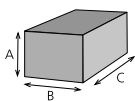
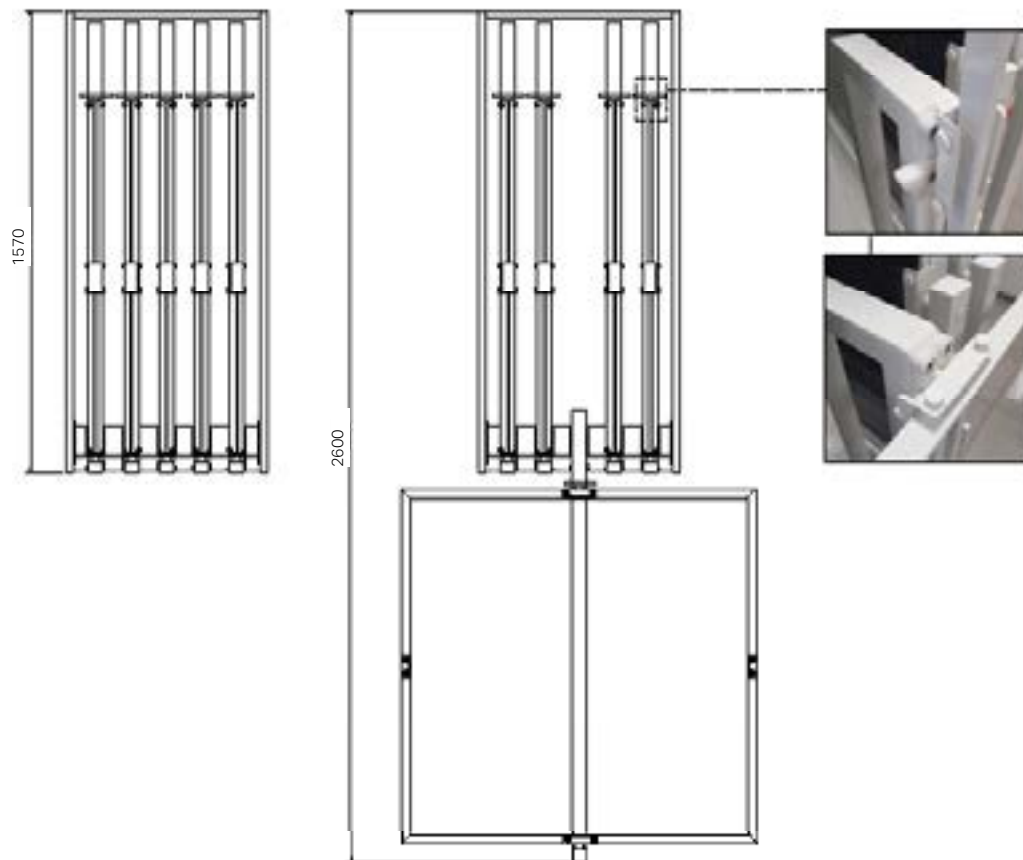
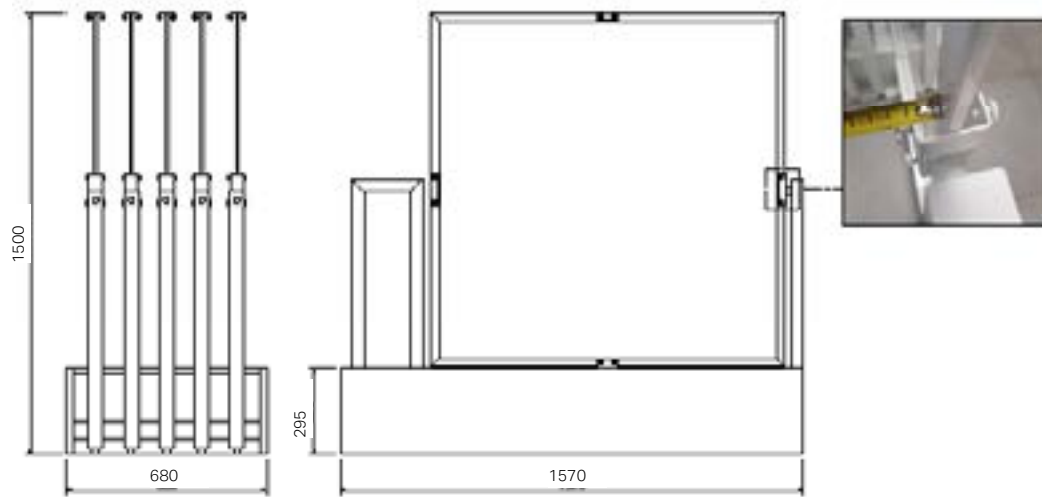

Espositore imballato (vuoto)  
Packaged display (empty)

A 111 cm

B 76 cm

C 164 cm

Peso/Weight

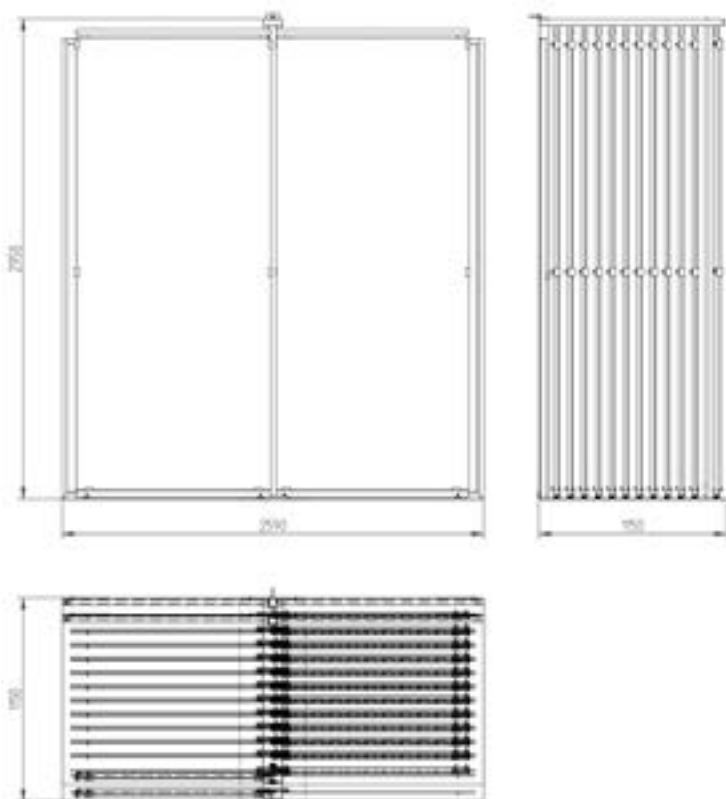

FESL02

2.100€

**ESPOSITORE x LASTRE 120x280**  
**14 LASTRE/SLABS 120X280**

**Non ne viene fatta scorta a magazzino ,  
viene disponibile dopo 45 gg dall' ordine .**

No stock is kept in the warehouse; it becomes available 45 days after ordering.

Espositore in metallo con pedana ultrapiatta in ferro verniciato senza tetto composto da 12 telai scorrevoli e 2 schiene fisse per allestire 14 lastre 280x120 cm, il pannello è **facoltativo**.

In caso di lastre stuoiate non si utilizza il pannello.

Metal display with extra-flat base, without roof, made up of 12 sliding frames and 2 fixed rear frames to arrange 14 slabs, 280x120 cm, the panel is **optional**.

In the case of on mesh slab, don't use the panel.

FESL02

**T. LAMBORGHINI 120x280 tono LAM**

**DISPONIBILI IN 45 GG LAVORATIVI**

AVAILABLE IN 45 WORKING DAYS

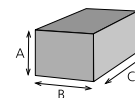

Espositore imballato (vuoto)  
Packaged display (empty)

A 93 cm

B 150 cm

C 300 cm

Peso/Weight



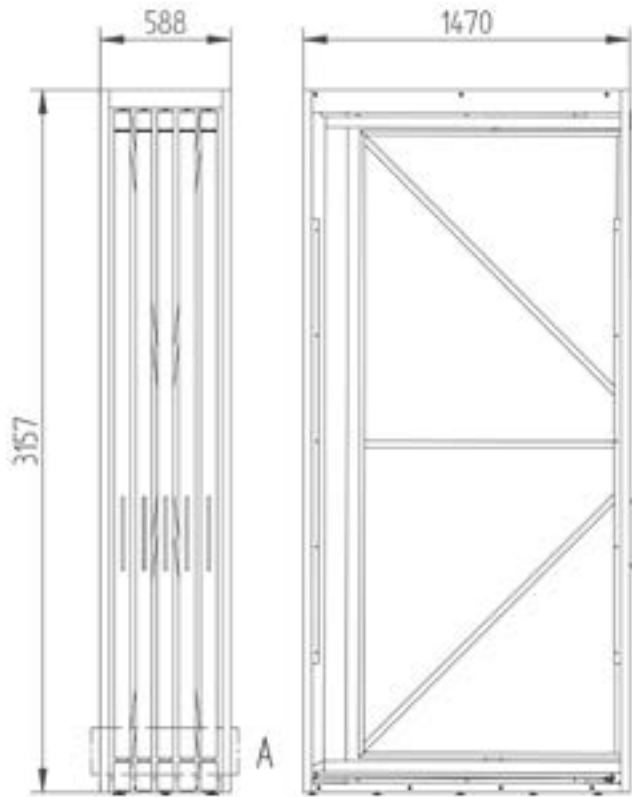

FESL04

**2.800€****ESPOSITORE SCORREVOLE****GIREVOLE/BIFACCIALE****LASTRE 120x280 - 120x240****10 LASTRE/SLABS 120X280 o 120x240**

**Non ne viene fatta scorta a magazzino ,  
viene disponibile dopo 45 gg dall' ordine .**

No stock is kept in the warehouse; it becomes available 45 days after ordering.

**POSSONO ESSERE UTILIZZATI ENTRAMBI I FORMATI**

Espositore contenente 5 telai girevoli bifacciali

**Per lastre sp 6 mm è necessario il pannello di supporto 1,8 cm  
che è all'interno dell' imballo.**

**Per lastre di misura 120x240 è già presente all'interno il pannello di  
tamponamento di misura 120x40h**

Display containing 5 double-sided revolving frames

For 6 mm thick slabs, a 1.8 cm support panel is required  
which is present within it

For slabs measuring 120x240, the 120x40h infill panel is already present  
inside

**DISPONIBILI IN 45 GG LAVORATIVI**

*AVAILABLE IN 45 WORKING DAYS*

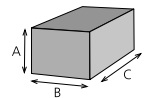

Espositore imballato (vuoto)  
*Packaged display (empty)*

A 85 cm

B 150 cm

C 360 cm

Peso/Weight

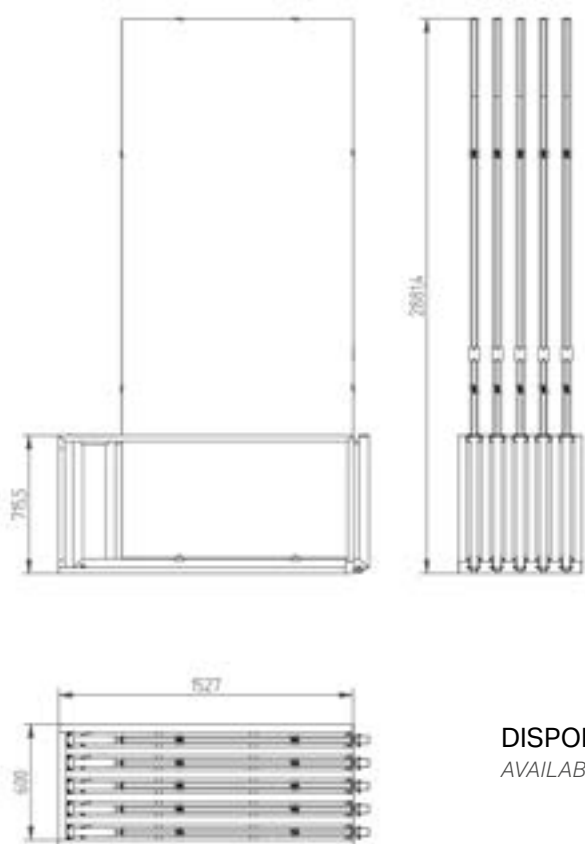

FESL05

1.200€

**ESPOSITORE BIFACCIALE SCORREVOLE  
LASTRE 120x280 - 120x240  
10 LASTRE/SLABS 120x280 o 120x240**

**Non ne viene fatta scorta a magazzino ,  
viene disponibile dopo 45 gg dall' ordine .**

No stock is kept in the warehouse; it becomes available 45 days after ordering.

POSSONO ESSERE UTILIZZATI ENTRAMBI I FORMATI  
Espositore contenente 5 telai bifacciali

BOTH FORMATS CAN BE USED  
Exhibitor contains 5 double-side

**DISPONIBILI IN 45 GG LAVORATIVI**  
AVAILABLE IN 45 WORKING DAYS

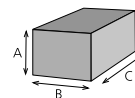

Espositore imballato (vuoto)  
Packaged display (empty)

A 78 cm

B 187 cm

C 278 cm

Peso/Weight

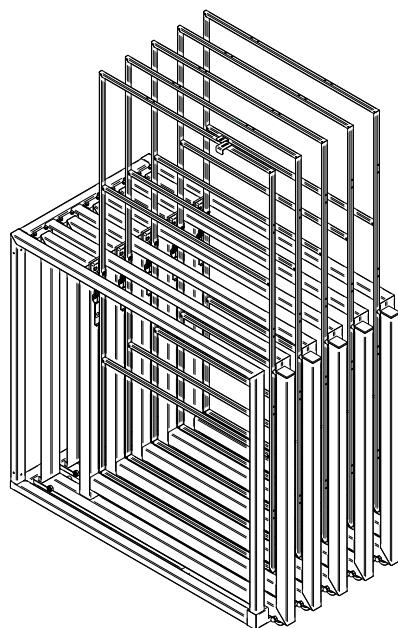

FESL07

850€

**TWISTER - ESPOSITORE BIFACCIALE  
ROTANTE SCORREVOLE LASTRE 80x160**

**10 LASTRE/SLABS 80x160**

Espositore contenente 10 lastre 80x160 sp 6mm

Exhibitor contains 10 slabs 80x160 thk 6mm

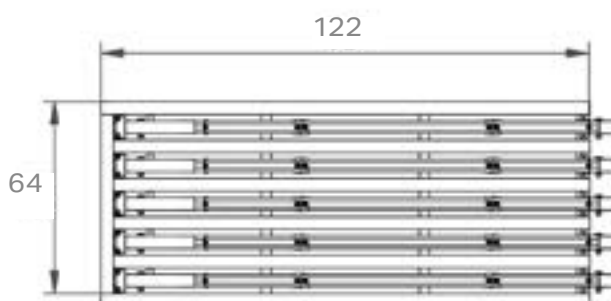
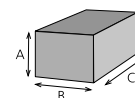

Espositore imballato (vuoto)  
Packaged display (empty)

A 30cm

B 115 cm

C 240 cm

Peso/Weight

**FINO AD ESAURIMENTO SCORTE**  
AVAILABILITY LIMITED IN STOCKS

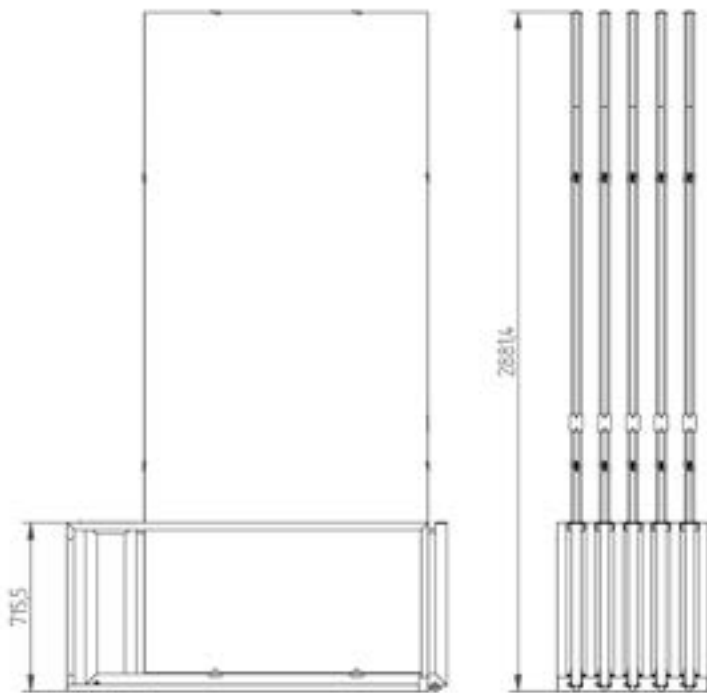

FESL08

**1100€****SLIDER MONOFACCIALE****120x280 - 120x240****5 LASTRE/SLABS 120x280 o 120x240**

**Non ne viene fatta scorta a magazzino ,  
viene disponibile dopo 45 gg dall' ordine .**

No stock is kept in the warehouse; it becomes available 45 days after ordering.

Espositore autoportante monofacciale contenente 5 lastre.

Exhibitor self-supporting single-side contains 5 slabs.

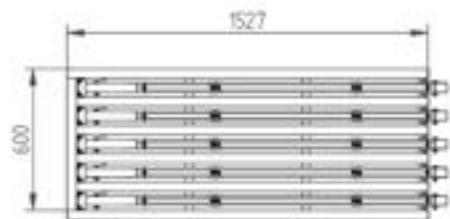
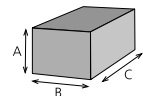
**DISPONIBILI IN 45 GG LAVORATIVI***AVAILABLE IN 45 WORKING DAYS*

Espositore imballato (vuoto)  
*Packaged display (empty)*

A 158 cm

B 66 cm

C 110 cm

Peso/Weight



## ESPOSITORE A CUNEO

per esporre lastre spessore 6mm  
formato 40x280 cm.  
Lastre non comprese.  
le lastre vanno ordinate con la nota  
del taglio a 40 x280 cm.

## WEDGE

for displaying slabs thickness 6mm  
size 40x280 cm.  
Sheets not included. Sheets should be ordered  
with a note specifying the cut at 40 x 280 cm."

Vi chiedo la cortesia di indicare sempre la posizione dei cunei se **dx** e **sx**  
in quanto in quelli dove va la predisposizione elettrica è predisposto in alto il cavo di uscita nell'ultimo pannello per la connessione  
elettrica.

I pannelli hanno la possibilità di essere montati fissandoli a muro dai nostri clienti.

I kindly ask you to always specify the position of the wedges as right (dx) and left (sx), especially in those where the electrical  
setup is provided. In these cases,  
the output cable is positioned at the top in the last panel for electrical connection. The panels can be mounted on the wall by our  
customers.

- Se richiesto con impianto elettrico , ogni cuneo arriva al cliente già con led, alimentatore e ponte per collegamento in serie.
- Per i tempi di consegna considerate 20 giorni lavorativi circa
- Di seguito i codici per l'ordine del singolo cuneo

**F99085 CUNEO PER LASTRE PARETE 75€**

Pannello cuneo truciolare grezzo formato 40x280 cm, predisposto per fissaggio a muro, atto a esporre 1 lastra tagliata di misura 40x280 cm, spessore 6 mm.

Sistema di fissaggio lastra sulla pannelolo truciolare tramite colla e silicone a carico del cliente.

Sbordatura lastra circa 3cm.

**F99086 CUNEO PER LASTRE PARTE CON LED + TRASFORMATORE 210€**

Pannello cuneo truciolare grezzo formato 40x280 cm con led + trasformatore, predisposto per fissaggio a muro, atto a esporre 1 lastra tagliata di misura 40x280 cm, spessore 6 mm.

Sistema di fissaggio lastra sulla pannelolo truciolare tramite colla e silicone a carico del cliente.

Sbordatura lastra circa 3cm.

Indicare in fase di ordine l'attacco del filo per l'uscita della luce , se in alto o in basso e se dx o sx.



COLLEZIONI  
Collection

# ABSOLUTE

LAFABBRICA AVAMERCHANDISING2024



## PANNELLI 100x200 SP 14 mm

BOARDS 100x200 THK 14 mm



**FABW109** € 70 ABSOLUTE WHITE NAT

**FABW209** € 80 ABSOLUTE WHITE LAP

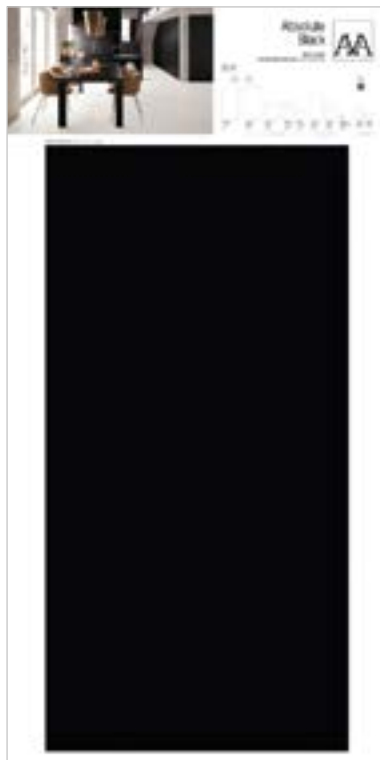

**FABS109** € 70 ABSOLUTE BLACK NAT

**FABS209** € 80 ABSOLUTE BLACK LAP





**PANNELLI 100x200 SP 14 mm**  
BOARDS 100x200 THK 14 mm



**FAST01 € 110 AESTHETICA HEGEL LAP**



**FAST02 € 110 AESTHETICA WILDE LAP**

# AGGLOMERATE

LAFABBRICAAVAMERCHANDISING2024



FAG0215

350€

**CULLA AGGLOMERATE**

Contenente 5 pannelli in MDF +  
4 piastrelle 20x120  
1 piastrella 60x120  
1 piastrella 60x60

Cradle contains 5 MDF panels +  
4 tiles thk 20x120  
1 tile thk 60x120  
1 tile 60x60

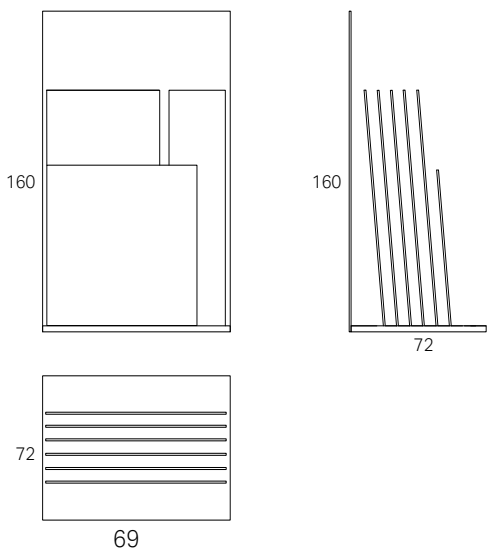

Set composition



Pearl 60x60 Nat. Ret.  
Bachetta  
Muretto Nat. Lap.  
L 61xH 120 cm



Decoro Fascia  
Pearl  
30x120 Lap.



Shell 30x60 Nat. Ret.  
Mosaico Freccia Nat. Lap.  
L 61xH 120 cm



Decoro Fascia  
Shell  
30x120 Lap.



20 mm  
L 30  
H 120 cm



Crowner  
L 90xH 160 cm



Agate 60x60 Nat. Ret.  
Quadrotto Nat. Lap.  
L 61xH 120 cm



Decoro Fascia  
Agate  
30x120 Lap.



Tahiti 60x60 Nat. Ret.  
Bachetta  
Muretto Nat. Lap.  
L 61xH 120 cm



Decoro Fascia  
Tahiti  
30x120 Lap.

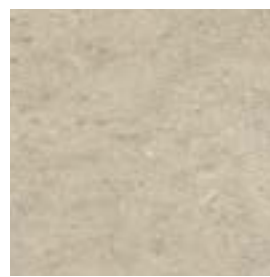

Shell 80x80 Nat. Ret.



Agate 60x120 Nat. Ret.

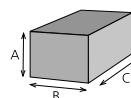

Espositore imballato (vuoto)  
Packaged display (empty)

A 67 cm

B 163 cm

C 83 cm

Peso/Weight

# AMAZON

LAFABBRICAAVAMERCHANDISING2024





**Sinottico 1**  
20x120 Kamba Nat. Ret.  
FAMA109 - 100x200 € 70



**Sinottico 4**  
7,5x40,7 Matis Nat.  
FAMA409 - 100x200 € 70

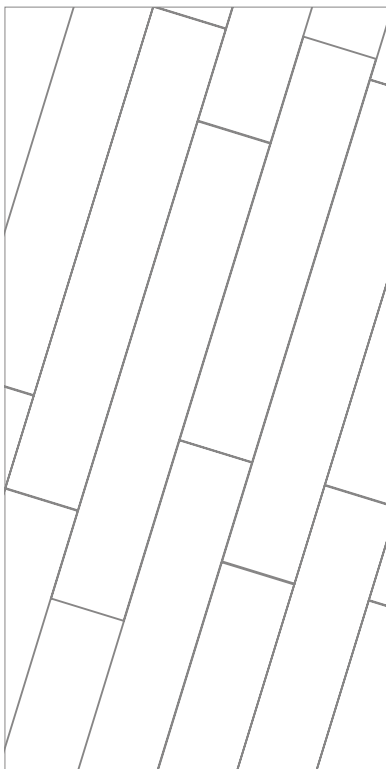

**Pannello Posato**  
FAM02 € 50/mq

**CULLA AMAZON +CA'FOSCARI**  
SET



F99017

290€

**CULLA  
AMAZON+  
CA' FOSCARI**

Contenente 8 pannelli in MDF  
Cradle contains 8 MDF panels

**FINO AD ESAURIMENTO SCORTE**  
*AVAILABILITY LIMITED IN STOCKS*

**Set composition**

Dimensioni pannelli  
*panels sizes*

47,3x 103,5 cm



**MATIS**  
7,5x45 Nat. Ret.



**NAWA, KAMBA,  
ARARA**  
7,5x45 Nat. Ret.



**KAMBA**  
7,5x40,7 Nat.



**ARARA, NAWA,  
MATIS**  
7,5x40,7 Nat.



**CANAPA**  
7,5x45 Nat. Ret.



**LINO, AVANA,  
TABACCO**  
7,5x45 Nat. Ret.



**TABACCO**  
7,5x40,7 Nat.



**LINO, CANAPA,  
AVANA**  
7,5x40,7 Nat.



FAMA02

270€  
**CULLA AMAZON**

Contenente 6 pannelli in MDF  
Cradle contains 6 MDF panels



FAMA01

230€  
**CULLA AMAZON**

**FINO AD ESAURIMENTO SCORTE**  
AVAILABILITY LIMITED IN STOCKS

**Set composition**

Dimensioni pannelli  
panels sizes

40x143,5 cm

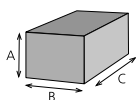

Espositore Display
A 153 cm
B 45 cm
C cm
Kg



**Arara**  
20x120 Nat. Ret.



**Nawa**  
20x120 Nat. Ret.



**Matis**  
20x120 Nat. Ret.



**Kamba**  
7,5x40 Nat.  
7,5x45 Nat.



**Riepilogativo**  
20mm



**Surma**  
20x120 Nat. Ret.



## PANNELLI 100x200 SP 14 mm

BOARDS 100x200 THK 14 mm

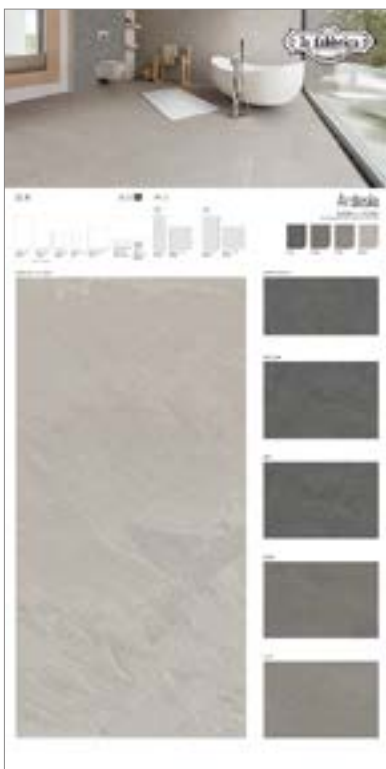

### Sinottico

60x120 Bianco Nat. Ret.

FARD209 - 100x200

€ 80

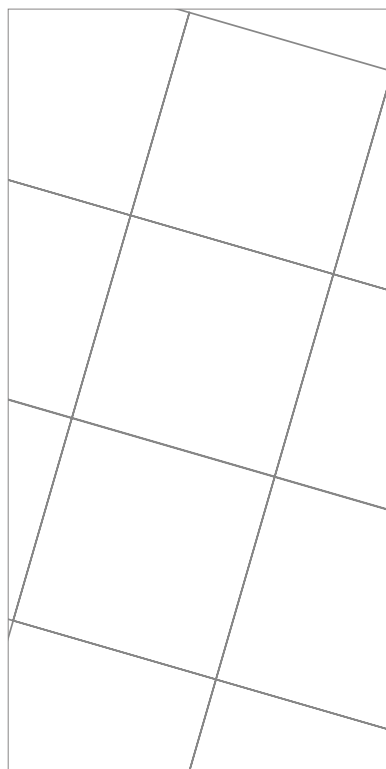

### Pannello Posato

FARD002

€ 50/mq





ESBH137

50€

**SCATOLA MURETTO 3D**

Scatola in cartone contenente 4 pezzi di muretto 3D 15x61 cm  
Cardboard box contains 4 pcs of muretto 3D 15x61 cm

Scatola con piastrelle  
Box with tiles

A 23 cm

B 64 cm

C 18,5 cm

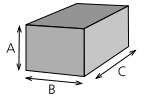

FINO AD ESAURIMENTO SCORTE  
AVAILABILITY LIMITED IN STOCKS

**CULLA ARDESIA**  
ARDESIA SET



FARD10

230€

**CULLA ARDESIA**

Contenente 6 pannelli in MDF  
Cradle contains 6 MDF panels



**Bianco**  
30x60 Nat. Ret.



**Taupe**  
60x120 Nat. Ret.



**Cenere**  
60x60 Nat. Ret.

FINO AD ESAURIMENTO SCORTE  
AVAILABILITY LIMITED IN STOCKS

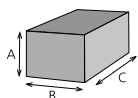

Espositore  
Display

A 170 cm

B 64 cm

C 60 cm

Kg 147

**Set composition**

Dimensioni pannelli  
panels sizes

61x151 cm



**Cenere**  
Muretto 15x61 Nat.



**Grigio**  
60x120 Nat. Ret.

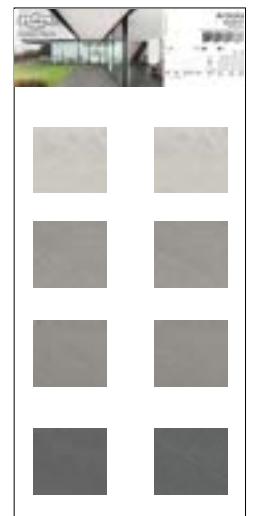

**Riepilogativo R11**  
10 mm / 20 mm

# ARTILE

LAFABBRICAAVAMERCHANDISING2024



**PANNELLI 100x200 SP 14 mm**  
BOARDS 100x200 THK 14 mm



**Sinottico 3**

Sage 60x120 Nat. Ret.

FAR309 - 100x200

€ 70

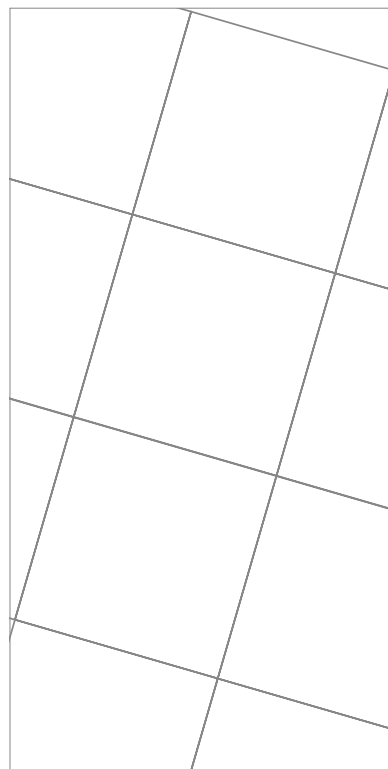

**Pannello Posato**

FART02

€ 50/mq



FAR0215

**200€**  
**CULLA ARTILE**

Contenente 6 pannelli in MDF +  
6 piastrelle 20x120 cm  
Cradle contains 6 MDF panels +  
6 tiles thk 20x120

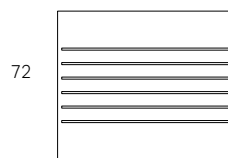
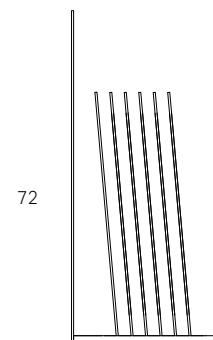
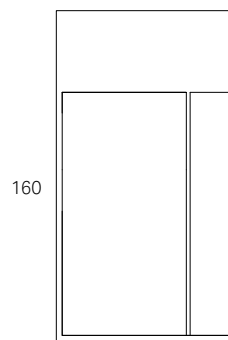

87

**FINO AD ESAURIMENTO SCORTE**  
*AVAILABILITY LIMITED IN STOCKS*

**Set composition**



Black Gold 60x60 Nat. Ret.  
6,1x37 Nat. Ret.  
Mosaico Nat. Ret.  
L 64xH 120 cm

Black Gold  
20x120  
Nat. Ret.



Sage 30x60 Nat. Ret.  
Esagona Nat. Ret.  
L 64xH 120 cm

Sage  
20x120  
Nat. Ret.



Ocean Blu 30x60 Nat. Ret.  
Esagona Nat. Ret.  
L 64xH 120 cm

Ocean Blu  
20x120  
Nat. Ret.

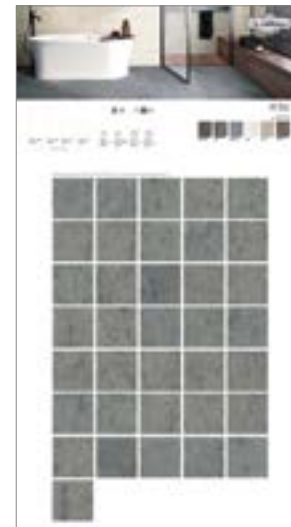

**Crown**  
L 87xH 160 cm



Copper 60x60 Nat. Ret.  
Muretto Nat. Ret.  
L 64xH 120 cm

Copper  
20x120  
Nat. Ret.



Ivory 6,1x37 Nat.  
L 64xH 120 cm

Ivory  
20x120  
Nat. Ret.



Greige 60x120 Nat. Ret.  
L 64xH 120 cm

Greige  
20x120  
Nat. Ret.

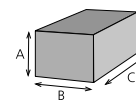

Espositore imballato (vuoto)  
Packaged display (empty)

A 42cm

B 132 cm

C 97 cm

Peso/Weight



FBLH03

12 €

**FOLDER BOLGHERI STONE**

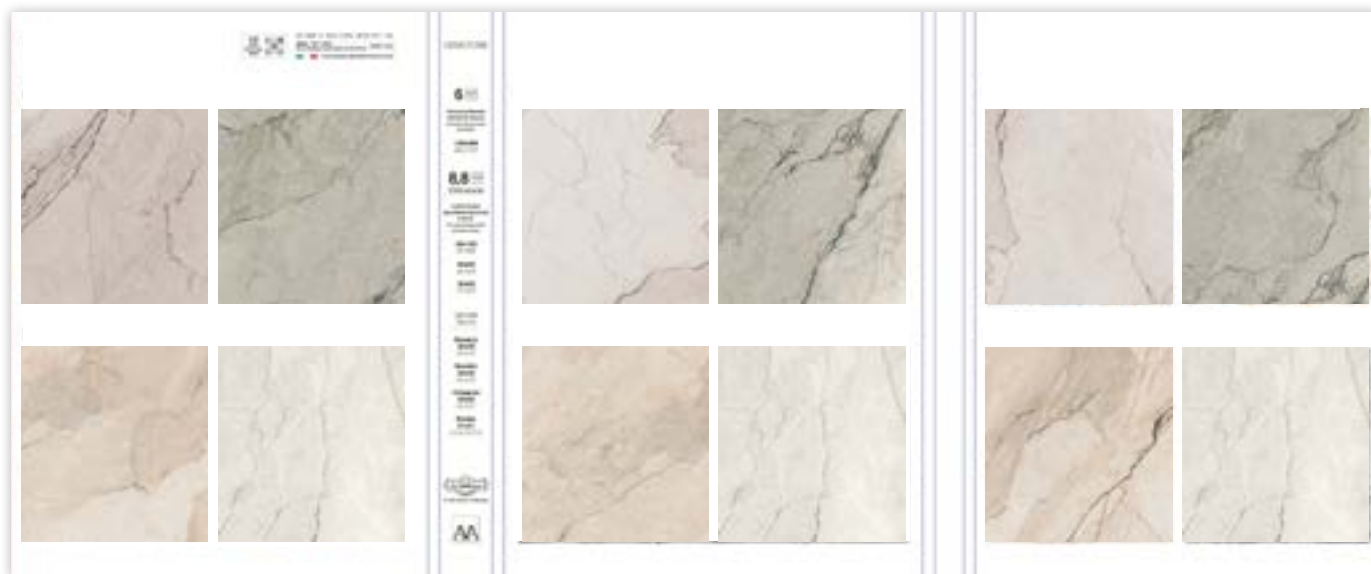

1 PZ WHITE NAT  
1 PZ BEIGE NAT  
1 PZ SAGE NAT  
1 PZ NATURAL NAT

1 PZ WHITE LAP  
1 PZ BEIGE LAP  
1 PZ SAGE LAP  
1 PZ NATURAL LAP

1 PZ WHITE 3D SAT  
1 PZ BEIGE 3D SAT  
1 PZ SAGE 3D SAT  
1 PZ NATURAL 3D SAT

**CULLA BOLGHERI STONE**  
BOLGHERI STONE SET

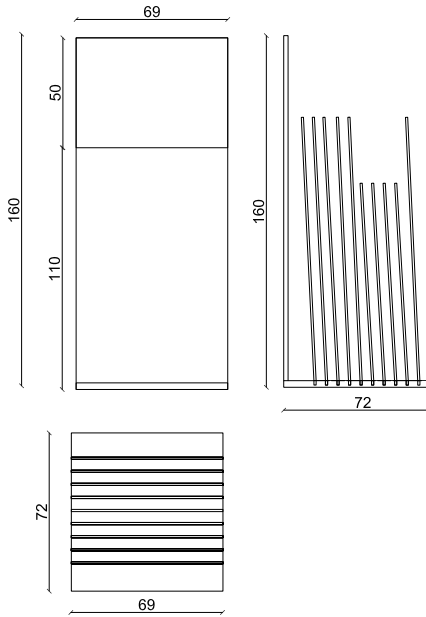

FBLH01

250 €

**CULLA BOLGHERI STONE**



**Set composition**

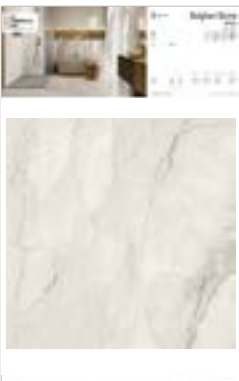

White 60x60 Nat.Ret.  
L 64xH 100 cm

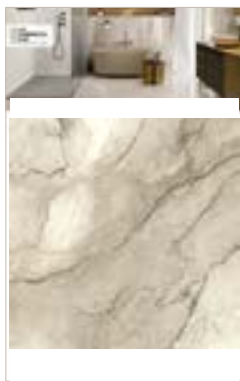

Beige 60x60 Nat.Ret.  
L 64xH 100 cm



Natural 60x60 Nat.Ret.  
L 64xH 100 cm



Sage 60x60 Nat.Ret.  
L 64xH 100 cm



Pannello schiena  
L 69xH 160 cm



White 60x120 Lap. Ret.  
L 60xH 120 cm



Beige 60x120 Lap. Ret.  
L 60xH 120 cm



Natural 60x120 3D Satin. Ret.  
L 60xH 120 cm



Sage 60x120 3D Satin. Ret.  
L 60xH 120 cm



Pannello ripiegativo  
mosaici  
L 40xH 120 cm

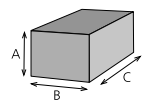

Espositore imballato (vuoto)  
Packaged display (empty)

A cm
B cm
C cm
Peso/Weight



FBLH04

480 €

**SET BOLGHERI STONE 60x120**

Espositore scorrevole monofacciale per 10 lastre 60x120  
Tutte le lastre avranno dietro la grafica su retrocartone  
risvoltato con stampa applicata lucida  
formato 59 cm x117 cm

ES GRAFICA

White Nat Ret



White Lap Ret

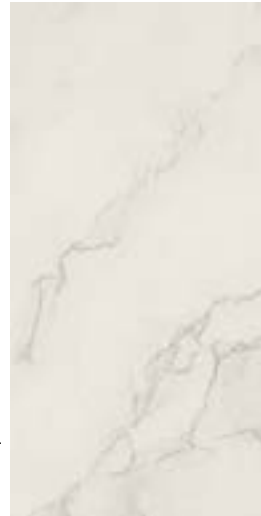

White 3D Sat Ret

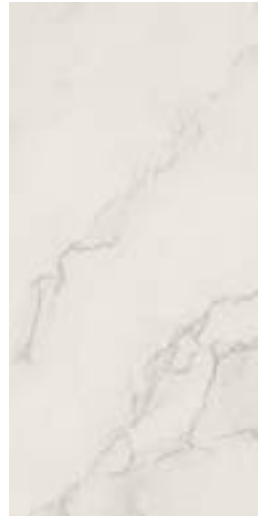

Beige Lap Ret

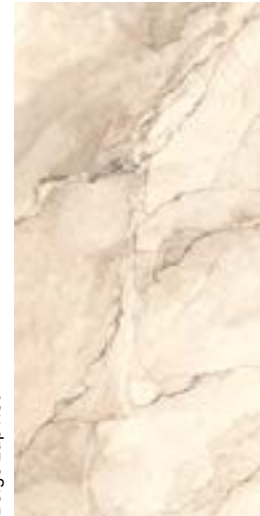

Beige 3D Sat Ret

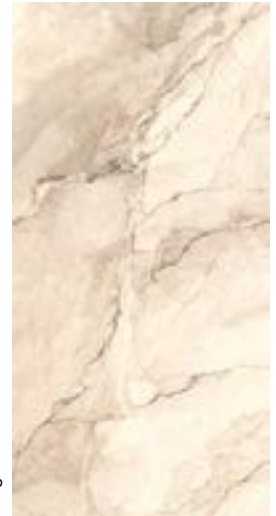

Natural Nat Ret



Natural Lap Ret



Natural 3D Sat Ret



Sage Lap Ret



Sage 3D Sat Ret



## PANNELLI 100x200 SP 14 mm

BOARDS 100x200 THK 14 mm



### Sinottico 1

- FBLH23 White 60x120 Lap Ret 80 €
- FBLH22 White 60x120 Nat Ret 80 €
- FBLH24 White 60x120 3D Satin Ret 80 €

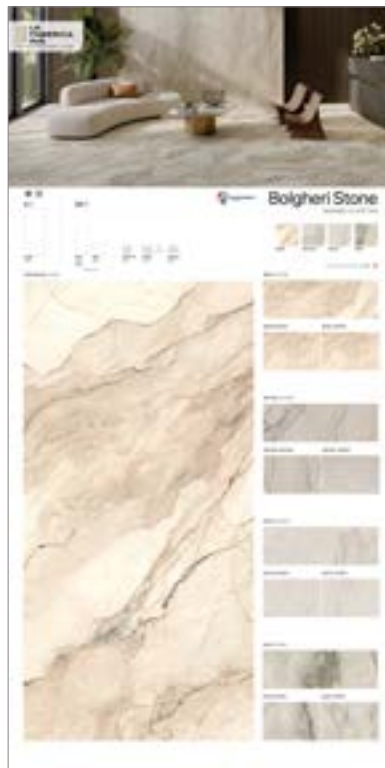

### Sinottico 2

- FBLH11 Beige 60x120 Lap Ret 80 €
- FBLH10 Beige 60x120 Nat Ret 80 €
- FBLH12 Beige 60x120 3D Satin Ret 80 €



### Sinottico 3

- FBLH15 Natural 60x120 Lap Ret 80 €
- FBLH14 Natural 60x120 Nat Ret 80 €
- FBLH16 Natural 60x120 3D Satin Ret 80 €



### Sinottico 4

- FBLH19 Sage 60x120 Lap Ret 80 €
- FBLH18 Sage 60x120 Nat Ret 80 €
- FBLH20 Sage 60x120 3D Satin Ret 80 €





**White**  
FBLH25 White 60x120 3D Satin Ret 95 €



**Beige**  
FBLH13 Beige 60x120 3D Satin Ret 95 €



**Natural**  
FBLH17 Natural 60x120 3D Satin Ret 95 €



**Sage**  
FBLH21 Sage 60x120 3D Satin Ret 95 €

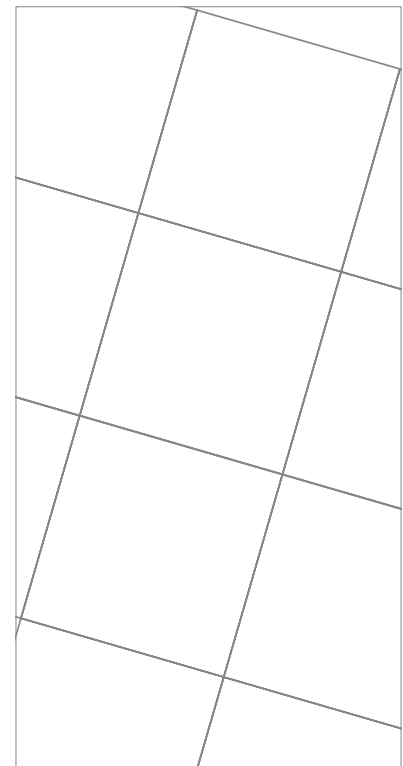

**Pannello Posato**  
FBLH02 85€/mq

FBLH05

270 €

### KIT BOLGHERI STONE 60x120

10 lastre 60x120

Tutte le lastre avranno dietro la grafica su retrocartone  
risvoltato con stampa applicata lucida  
formato 59 cm x117 cm

All panels will have graphics on the back with a folded  
backing board and applied glossy print,  
size 59 cm x 117 cm.



ES GRAFICA



White Nat Ret

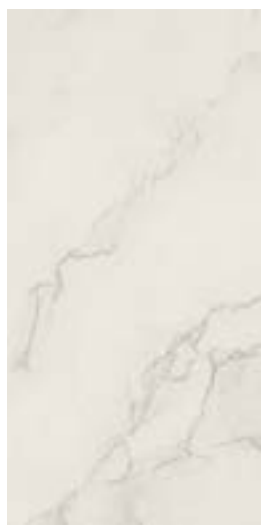

White Lap Ret

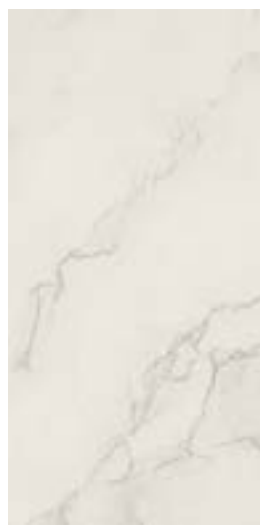

White 3D Sat Ret

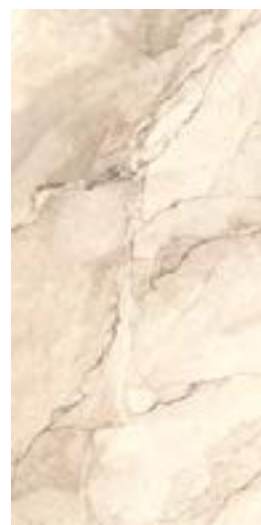

Beige Lap Ret



Beige 3D Sat Ret



Natural Nat Ret



Natural Lap Ret



Natural 3D Sat Ret



Sage Lap Ret



Sage 3D Sat Ret



FESL13

**390€**

### **TOTEM LASTRE**

**Totem centrosala singolo contenente 2 lastre 120x280**  
**Il prezzo si intende senza lastre**

Single center room totem contains 2 120x280 slabs  
The price is without slabs

CARTELLE AGENTI BOLGHERI STONE 60x60



FBLH09

35 €

1 PZ 30x60 WHITE NAT  
1 PZ 30x60 WHITE LAP  
1 PZ 60x60 WHITE 3D SATIN



FBLH06

35 €

1 PZ 30x60 BEIGE NAT  
1 PZ 30x60 BEIGE LAP  
1 PZ 60x60 BEIGE 3D SATIN



FBLH07

35 €

1 PZ 30x60 NATURAL NAT  
1 PZ 30x60 NATURAL LAP  
1 PZ 60x60 NATURAL 3D SATIN

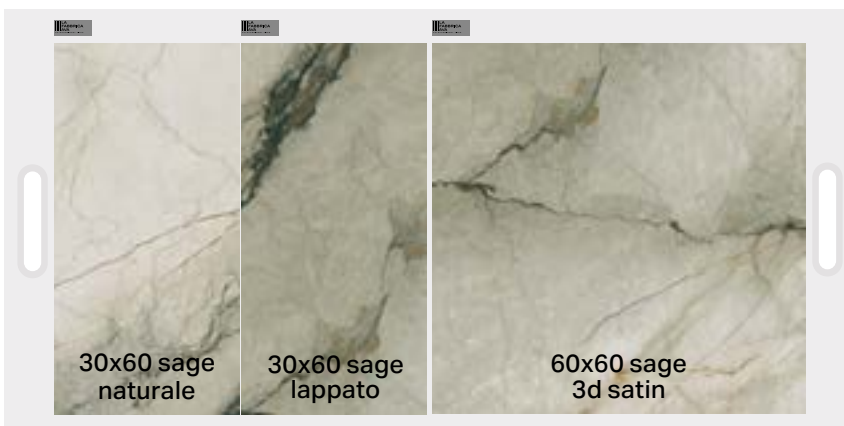

FBLH08

35 €

1 PZ 30x60 SAGE NAT  
1 PZ 30x60 SAGE LAP  
1 PZ 60x60 SAGE 3D SATIN



# BORGHI ITALIANI

LAFABBRICA AVAMERCHANDISING 2024



## PANNELLI 100x200 SP 14 mm

BOARDS 100x200 THK 14 mm

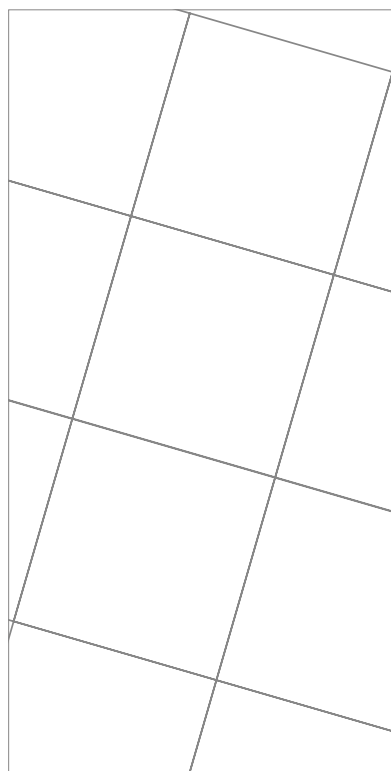

Pannello Posato

FBI02

€ 50/mq



FBI0115

160€

**CULLA BORGHI ITALIANI**

Contenente 5 pannelli in MDF  
Cradle contains 5 MDF panels

**FINO AD ESAURIMENTO SCORTE**  
AVAILABILITY LIMITED IN STOCKS

**Set composition**



Calce  
60,9x40,6 Nat.  
40,6x40,6 Nat.  
20,3x20,3 Nat.  
L 64xH 110 cm



Silice  
20,3x40,6 Nat.  
20,3x20,3 Nat.  
L 64xH 110 cm



Cenere  
20,3x40,6 Nat.  
20,3x20,3 Nat.  
L 64xH 110 cm



Agata  
40,6x40,6 Nat.  
20,3x40,6 Nat.  
20,3x20,3 Nat.  
L 64xH 110 cm



Grafite  
60,9x40,6 Nat.  
20,3x40,6 Nat.  
20,3x20,3 Nat.  
L 64xH 110 cm

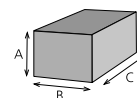

Espositore imballato (vuoto) <i>Packaged display (empty)</i>
A 42 cm
B 163 cm
C 82 cm
Peso/Weight



FESP108

950€

### TWISTER 120x120

Espositori a 5 carrelli bifacciali scorrevoli e girevoli a 180°

Richiedere il pannello F00120  
con l'utilizzo di piastrelle spessore 6mm

o da abbinare ai pannelli posati

Exhibitors with 5 double-sided sliding and 180° rotating trolleys

Request panel F00120  
with the use of 6mm thick tiles  
or to combine with the laid panels

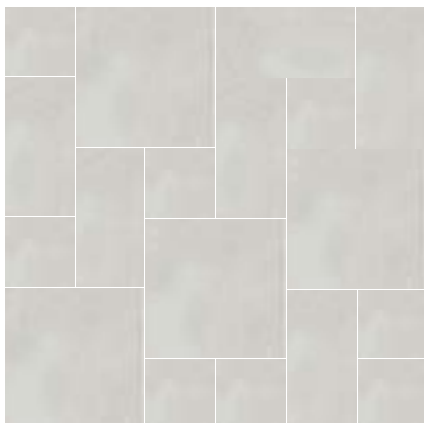

Cenere 120x120



Agata 120x120



Calce 120x120



Agata + Grafite 120x120



Grafite 120x120

FBI0124

160€

### KIT 5 PANNELLI BORGHI ITALIANI





# BRECCIA ARGENTUM

LAFABBRICAAVAMERCHANDISING2024



**PANNELLI 100x200 SP 14 mm**

BOARDS 100x200 THK 14 mm



**FBRE109 € 70 BRECCIA ARGENTUM NAT**



**FBRE209 € 80 BRECCIA ARGENTUM LAP**



**PANNELLI 100x200 SP 14 mm**  
BOARDS 100x200 THK 14 mm



**FBR001**

**€ 170** BRONZE AMANI LAP





F99017

290€

**CULLA  
AMAZON+  
CA' FOSCARI**

Contenente 8 pannelli in MDF  
Cradle contains 8 MDF panels

**FINO AD ESAURIMENTO SCORTE**  
AVAILABILITY LIMITED IN STOCKS

**Set composition**

Dimensioni pannelli  
panels sizes

47,3x 103,5 cm



**MATIS**  
7,5x45 Nat. Ret.



**NAWA, KAMBA,  
ARARA**  
7,5x45 Nat. Ret.



**KAMBA**  
7,5x40,7 Nat. Ret.



**ARARA, NAWA,  
MATIS**  
7,5x40,7 Nat. Ret.



**CANAPA**  
7,5x45 Nat. Ret.



**LINO, AVANA,  
TABACCO**  
7,5x45 Nat. Ret.



**TABACCO**  
7,5x40,7 Nat. Ret.



**LINO, CANAPA,  
AVANA**  
7,5x40,7 Nat. Ret.

**PANNELLI 100x200 SP 14 mm**  
BOARDS 100x200 THK 14 mm



**Sinottico 1**  
Canapa 20x120 Nat. Ret.  
FCAF109 - 100x200 € 70



**Sinottico 2**  
Avana 20x120 Nat. Ret.  
FCAF209 - 100x200 € 70



**Sinottico 3**  
Tabacco 20x120 Nat. Ret.  
FCAF309 - 100x200 € 70



**Sinottico 4**  
7,5x40,7 Chevron Canapa Nat. Ret.  
FCAF409 - 100x200 € 70

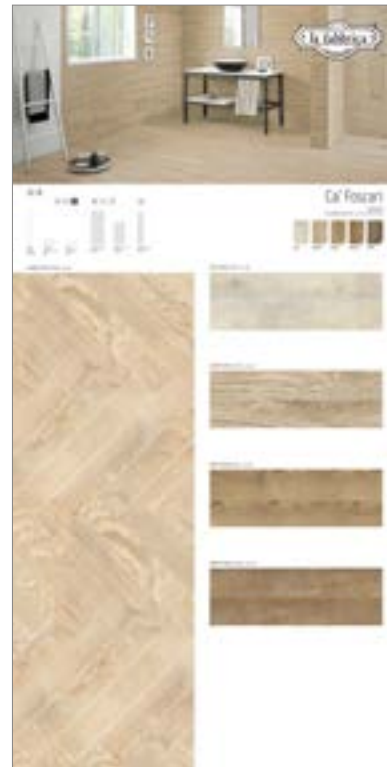

**Sinottico 5**  
7,5x45 Listello Canapa Nat. Ret.  
FCAF509 - 100x200 € 70

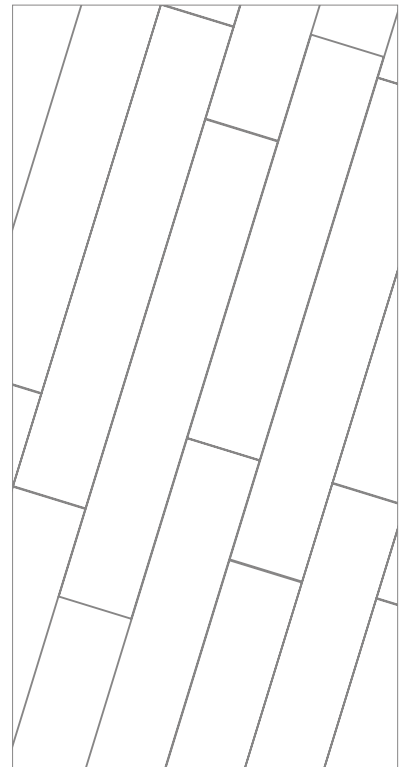

**Pannello Posato**  
FCF02 € 50/mq



FCAF03

400€

**ESPOSITORE OUTDOOR**

**CA'FOSCARI** 120x100 cm.

+ KIT OUTDOOR CA'FOSCARI +BANNER

- 1 PZ 40x120 AVANA 20 mm
- 1 PZ 40x120 MORO 20 mm
- 3 PZ 20x40 LINO 20 mm
  - CANAPA 20 mm
  - TABACCO 20 mm

**FINO AD ESAURIMENTO SCORTE**  
*AVAILABILITY LIMITED IN STOCKS*



# CALACATTA ORO

LAFABBRICA AVAMERCHANDISING 2024



**PANNELLI 100x200 SP 14 mm**

BOARDS 100x200 THK 14 mm



**FCA0109**

**€ 70 CALACATTA ORO NAT**



**FCA0209**

**€ 70 CALACATTA ORO LAP**





**PANNELLI 100x200 SP 14 mm**  
BOARDS 100x200 THK 14 mm



**Sinottico 1**  
Balmoral 60x120 Lap. Ret.  
FCAS109 - 100x200

€ 85

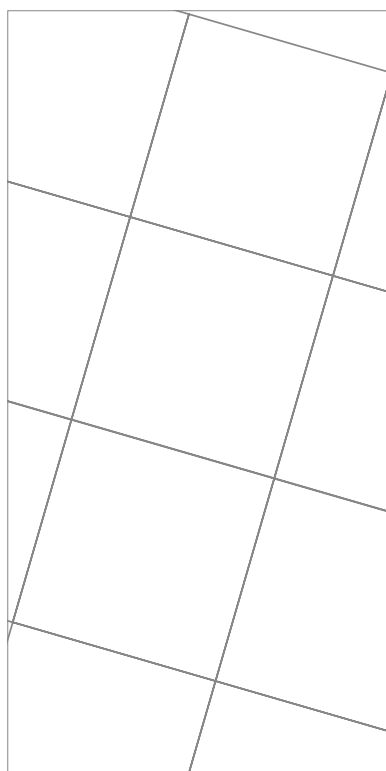

**Pannello Posato**

FCAST02

€ 50/mq

# CHIANCA

LAFABBRICA AVAMERCHANDISING2024





Sinottico Otranto  
100x100 Nat. Ret.  
FCHN16 - 100x200 € 100



Sinottico Ostuni  
100x100 Nat. Ret.  
FCHN14 - 100x200 € 100



Sinottico Cursi  
100x100 Nat. Ret.  
FCHN12 - 100x200 € 100



Sinottico Carparo  
100x100 Nat. Ret.  
FCHN10 - 100x200 € 100

**PANNELLI 100x200 SP 14 mm**  
BOARDS 100x200 THK 14 mm



**Sinottico Cursi**  
60x120 Nat. Ret.  
FCHN13 - 100x200 € 85



**Sinottico Carparo**  
60x120 Nat. Ret.  
FCHN11 - 100x200 € 85



**Sinottico Otranto**  
60x120 Nat. Ret.  
FCHN17 - 100x200 € 85



**Sinottico Ostuni**  
60x120 Nat. Ret.  
FCHN15 - 100x200 € 85

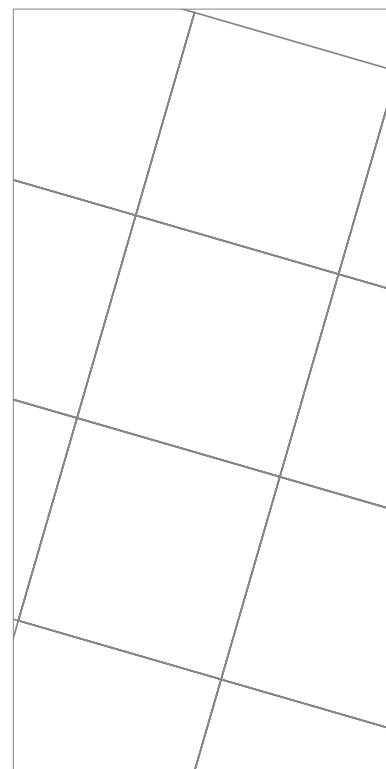

**Pannello Posato**  
FCHN02 € 50/mq



**Otranto**  
40,6x60,9 - 40,6x40,6 - 20,3x40,6 - 20,3x20,3  
FCHN23 - 100x200 € 95



**Ostuni**  
40,6x60,9 - 40,6x40,6 - 20,3x40,6 - 20,3x20,3  
FCHN21 - 100x200 € 95



**Cursi**  
60,9x60,9 - 40,6x40,6 - 20,3x40,6 - 20,3x20,3  
FCHN19 - 100x200 € 95



**Carparo**  
40,6x60,9 - 40,6x40,6 - 20,3x40,6 - 20,3x20,3  
FCHN18 - 100x200 € 95



**Ostuni R11**  
60,9x60,9 - 40,6x40,6 - 20,3x40,6 - 20,3x20,3  
FCHN22 - 100x200 € 95



**Cursi R11**  
40,6x60,9 - 40,6x40,6 - 20,3x40,6 - 20,3x20,3  
FCHN20 - 100x200 € 95

## KIT 4 PEZZI 60X120

4 PIECES KIT 60X120

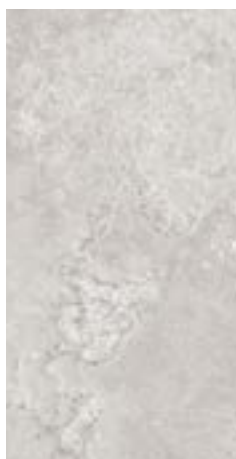

Otranto 60x120 Nat. Ret.



Carparo 60x120 Nat. Ret.



Cursi 60x120 Nat. Ret.



Ostuni 60x120 Nat. Ret.

FCHN03

45€

KIT 4 PEZZI 60x120

FINO AD ESAURIMENTO SCORTE  
AVAILABILITY LIMITED IN STOCKS

## ARTICOLI VERSIONE 9 GESTITI AL PEZZO DA ABBINARE AL FESP02

100 x100 FOR FESP02



Otranto 100x100 Nat Ret  
cod. 184064



Otranto 100x100 Nat Ret R11  
cod. 184054



Ostuni 100x100 Nat Ret  
cod. 184061



Ostuni 100x100 Nat Ret R11  
cod. 184051



Cursi 100x100 Nat Ret  
cod. 184062



Cursi 100x100 Nat Ret R11  
cod. 184052



Carparo 100x100 Nat Ret R11  
cod. 184053



Carparo 100x100 Nat Ret  
cod. 184063



FCHN07

290€

**CULLA CHIANCA**

8 pannelli 62x110 con posa multiformato  
 1 pannello schiena 69x160 con grafica

Cradle contains 8 MDF panels

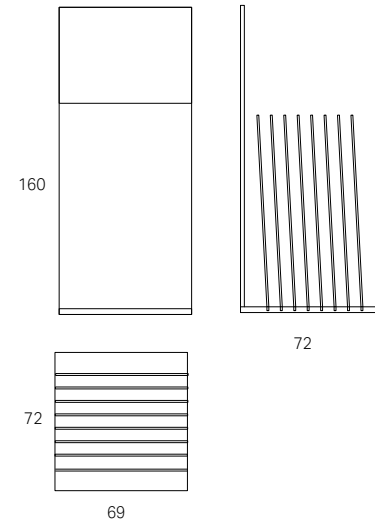

Set composition



Otranto  
 40,6x60,9 - 40,6x40,6 -  
 20,3x40,6 Nat.  
 L 62xH 110 cm



Carparo  
 40,6x60,9 - 40,6x40,6 -  
 20,3x40,6 Nat.  
 L 62xH 110 cm

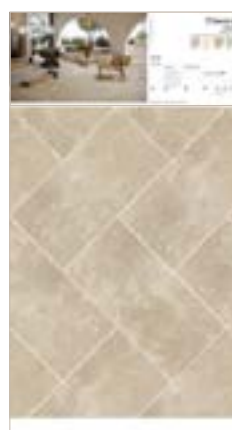

Cursi  
 20,3x40,6 Nat.  
 L 62xH 110 cm



Ostuni  
 20,3x40,6 Nat.  
 L 62xH 110 cm



Ostuni  
 40,6x60,9 - 40,6x40,6 -  
 20,3x40,6 Nat. + R11  
 L 62xH 110 cm



Cursi  
 40,6x60,9 - 40,6x40,6 -  
 20,3x40,6 Nat. + R11  
 L 62xH 110 cm

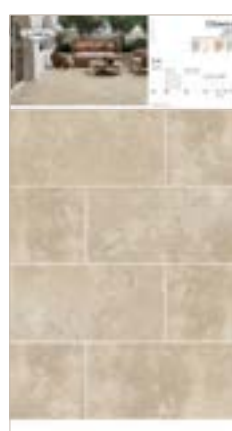

Cursi  
 20,3x40,6 R11  
 L 62xH 110 cm



Ostuni  
 20,3x40,6 R11  
 L 62xH 110 cm



Pannello schiena  
 L 69x H 160 cm

# CULLA CHIANCA ESTERO

CHIANCA SET



FCHN01

220€

## CULLA CHIANCA

4 pannelli 62x110 con posa multiformato  
4 piastrelle 60x120  
1 pannello schiena 69x160 con grafica

Cradle contains 5 MDF panels  
4 tiles thk 60x120

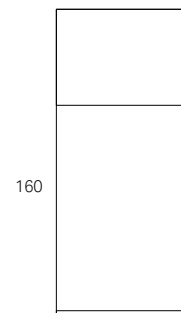

160

72

69

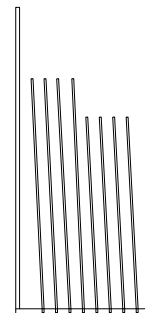

72

### Set composition



Otranto  
40,6x60,9 - 40,6x40,6 -  
20,3x40,6 Nat.  
L 62xH 110 cm



Carparo  
40,6x60,9 - 40,6x40,6 -  
20,3x40,6 Nat.  
L 62xH 110 cm



Otranto 60x120 Nat. Ret.

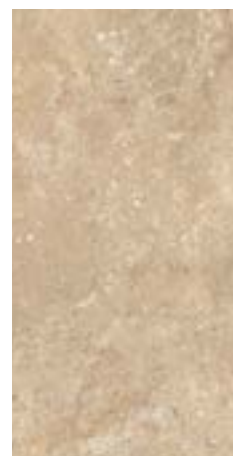

Carparo 60x120 Nat. Ret.



Ostuni  
40,6x60,9 - 40,6x40,6 -  
20,3x40,6 Nat. + R11  
L 62xH 110 cm



Cursi  
40,6x60,9 - 40,6x40,6 -  
20,3x40,6 Nat. + R11  
L 62xH 110 cm



Cursi 60x120 Nat. Ret.



Ostuni 60x120 Nat. Ret.



Pannello schiena  
L 69xH 160 cm





Carparo multiformato Nat



Otranto multiformato Nat

FCHN04

220 €

**KIT 4 pannelli per FESP108**

4 pannelli 120x120



Cursi multiformato Nat R11



Ostuni multiformato Nat R11



FESP108

950€

**TWISTER 120x120**

Espositori a 5 carrelli bifacciali scorrevoli e girevoli a 180°

Richiedere il pannello F00120  
con l'utilizzo di piastrelle spessore 6mm  
o da abbinare ai pannelli posati

Exhibitors with 5 double-sided sliding and 180° rotating trolleys

Request panel F00120

with the use of 6mm thick tiles

or to combine with the laid panels

## CARTELLA 20mm

BOARDS H20



FCHN25

27€

### CARTELLA 20MM 56x65

4 PEZZI 10x30CM in 20MM

OTRANTO  
OSTUNI  
CARPARO  
CURSI

A COMPLEMENTO DI FBAS07

**FINO AD ESAURIMENTO SCORTE**  
*AVAILABILITY LIMITED IN STOCKS*



FCHN08

18€

**CARTELLA 64x70  
MURETTI CHIANGA**

OTRANTO MURETTO 15x61  
OSTUNI MURETTO 15x61  
CARPARO MURETTO 15x61

**FINO AD ESAURIMENTO SCORTE**  
*AVAILABILITY LIMITED IN STOCKS*

**ESPOSITORE A CAVALLETTO DA ESTERNO**  
OUTDOOR SOLUTION



FESP11

350€

**ESPOSITORE AD A**

BIFACCIALE 130x140



FESP12

300€

**ESPOSITORE**

MONOFACCIALE 130x140



Cursi 60,9x60,9 - 40,6x60,9 - 40,6x40,6  
8,8MM R11

FCHN28 130x140

100 €



Cursi 20,3x20,3 - 20,3x40,6 - 40,6x40,6 - 40,6x60,9  
8,8MM R11

FCHN29 130x140

100 €



Ostuni 60,9x60,9 - 40,6x60,9 - 40,6x40,6  
8,8MM R11

FCHN30 130x140

100 €



Ostuni 20,3x20,3 - 20,3x40,6 - 40,6x40,6 - 40,6x60,9  
8,8MM R11

FCHN31 130x140

100 €



Otranto 100x100 8,8MM R11

FCHN32 130x140

100 €



Carparo 100x100 8,8MM R11

FCHN27 130x140

100 €

# COTTO DEL CASALE

LAFABBRICA AVAMERCHANDISING2024



## PANNELLI 100x200 SP 14 mm

BOARDS 100x200 THK 14 mm

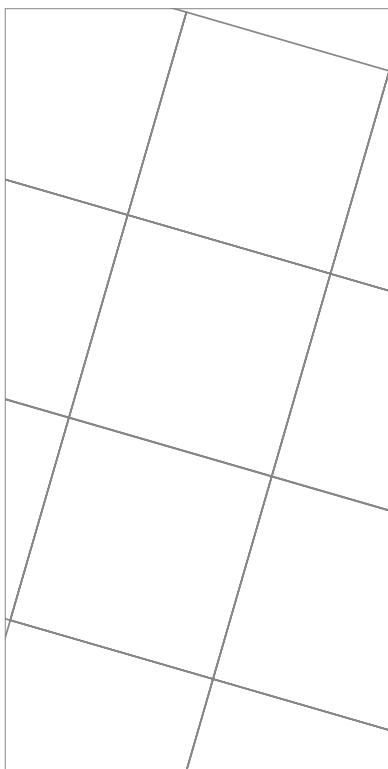

Pannello Posato

FCC02

€ 50/mq

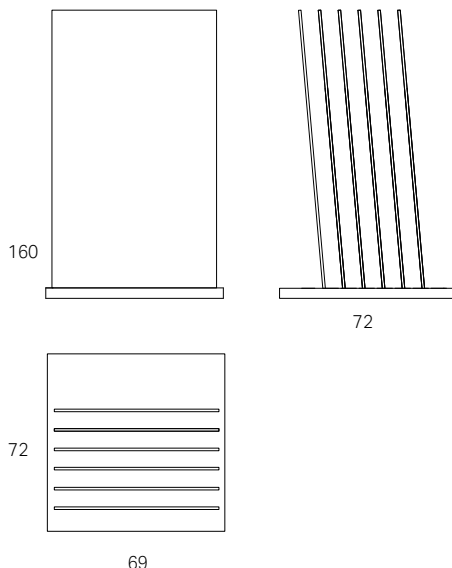

FCC0215

280€

**CULLA  
COTTO DEL CASALE**

contenente 6 pannelli in MDF  
Cradle contains 6 MDF

**FINO AD ESAURIMENTO SCORTE**  
AVAILABILITY LIMITED IN STOCKS

Set composition



**Greige**  
60,9x60,9 Nat.  
20,3x40,6 Nat.  
20,3x20,3 Nat.  
L 64xH 110 cm



**Bruno**  
40,6x60,9 Nat.  
20,3x40,6 Nat.  
20,3x20,3 Nat.  
L 64xH 110 cm



**Rosado**  
40,6x40,6 Nat.  
20,3x20,3 Nat.  
40,6x60,9 Nat.  
Decoro Capri 20,3x20,3 Luc.  
L 64xH 110 cm



**Bruno R11**  
20,3x40,6 Nat.  
20,3x20,3 Nat.  
L 64xH 110 cm



**Odra**  
40,6x40,6 Nat.  
20,3x40,6 Nat.  
20,3x20,3 Nat.  
Decoro Pompei 20,3x20,3 Sat.  
L 64xH 110 cm



**Odra**  
20,3x20,3 Nat.  
Decoro Pompei 20,3x20,3 Sat.  
Decoro Fascia Pompei 10x20,3 Sat.  
L 64xH 110 cm

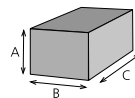

Espositore imballato (vuoto)  
Packaged display (empty)

A 42 cm

B 163 cm

C 82 cm

Peso/Weight

# COTTO DEL CASALE

LAFABBRICA AVAMERCHANDISING 2024



FESP108

950€

## TWISTER 120x120

Espositori a 5 carrelli bifacciali scorrevoli e girevoli a 180°

Richiedere il pannello F00120  
con l'utilizzo di piastrelle spessore 6mm  
o da abbinare ai pannelli posati

Exhibitors with 5 double-sided sliding and 180° rotating trolleys

Request panel F00120

with the use of 6mm thick tiles

or to combine with the laid panels



Greige 120x120

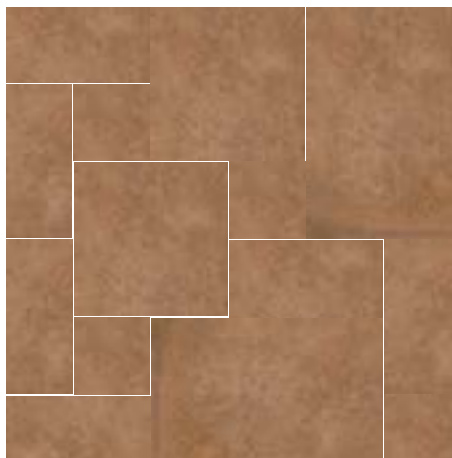

Bruno 120x120 R11



Rosado 120x120



Rosado 120x120



Ocra 120x120

FCC0124

200€

## KIT 5 PANNELLI

120x120 COTTO DEL CASALE

**FINO AD ESAURIMENTO SCORTE**  
AVAILABILITY LIMITED IN STOCKS





# DEEP STONE

LAFABBRICAAVAMERCHANDISING2024



CATALOGO  
CATALOG

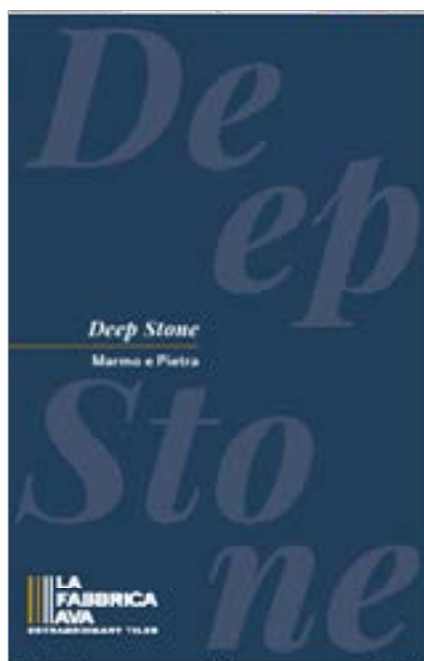

FDPS00

1,6 €

CATALOGO DEEP STONE

FDPS03

14€  
FOLDER DEEP STONE



**CARATTERISTICHE TECNICHE**  
Sostanze nocive: Cadmio, Cromo(VI), Nichel, Piombo, Stagno, Uranio

Normal size (cm): 30x60, 60x60, 60x120, 100x100, 120x120, 120x240	Thickness (mm): 6, 8, 8, 20
Color: Beige/taupe	Surface: natural Product Group: B1a-VGL

Technical characteristics	Test method	EN 14681 and ISO 13009 requirements	Actual Average values
Length and width	ISO 10545-2	±0.5% and ± 3.0mm	Compliant
Straightness of sides	ISO 10545-2	Rect.: ±0.30, and ± 3.0mm	Compliant
Rectangularity	ISO 10545-2	±0.30 and ± 3.0mm	Compliant
Flatness	ISO 10545-2	Rect.: ±0.30, and ± 3.0mm	Compliant
Thickness	ISO 10545-2	±0.4% and ± 3.0mm	Compliant
Water absorption	ISO 10545-3	≤ 0.5%	Compliant
Modulus of rupture	ISO 10545-4	≥ 35 N/mm <sup>2</sup>	Compliant
Breaking strength (2)	ISO 10545-4	≥ 3300 N	Compliant
Abrasion resistance	ISO 10545-7	≥ 175 mm <sup>3</sup>	Compliant
Linear thermal expansion	ISO 10545-6	Declared value	≤ 7.3x10 <sup>-6</sup> °C <sup>-1</sup>
Thermal shock resistance	ISO 10545-9	No alterations	Resistant
Frost resistance	ISO 10545-12	No alterations	Resistant
Chemical resistance	ISO 10545-13	Declared value	LA → HA
Flexural strength	ISO 10545-5	≥ 8 mm	A
Stain resistance	ISO 10545-14	Class 3 min.	3
Slip Resistance	UNI EN 12518	≥ 0.42	2
	DIN 51130	Declared value	R10 - R11 (foot)
	DIN 51077	Declared value	3 - 5 (Clim)
	ANSI A32.3	Declared value	> 0.42
	B.C.R.A. (Imp. 01/01)	Declared value	7
	BS 7976	Declared value	7
Stain variation	ISO 10545-15	Not required	3/3
Few reaction	UNI EN 13052-3	Not required	A1, class
Thermal Conductivity	EN 12524	Not required	λ = 1.3 W/m °K
Light and colour fastness	EN 12054	Not required	No variations

9

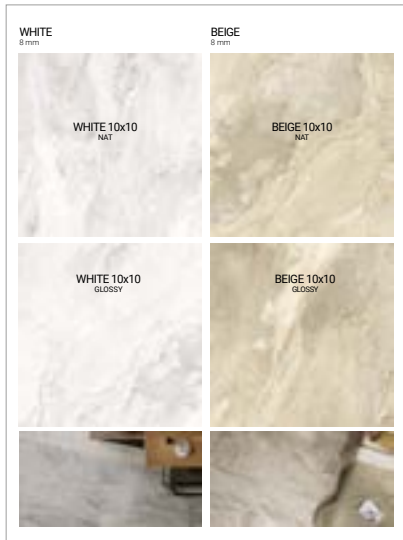

Deep Stone

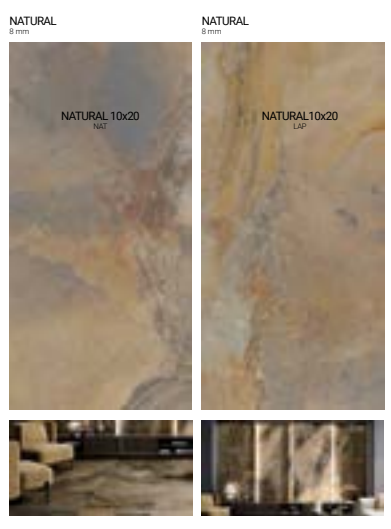

1 PZ WHITE NAT  
1 PZ WHITE LAP  
1 PZ NATURAL NAT  
1 PZ NATURAL LAP

1 PZ NATURAL NAT  
1 PZ NATURAL LAP

1 PZ BLUE NAT  
1 PZ BLUE LAP

## PANNELLI 100x200 SP 14 mm

BOARDS 100x200 THK 14 mm



### Sinottico 1

FDPS White 60x120 Lap Ret €

FDPS White 60x120 Nat Ret €



### Sinottico 3

FDPS Beig 60x120 Lap Ret €

FDPS Beige 60x120 Nat Ret €



### Sinottico 4

FDPS Blue 60x120 Lap Ret €

FDPS Blue 60x120 Nat Ret €



### Sinottico 60x120

FDPS Natural 60x120 Lap Ret €

FDPS Natural 60x120 Nat Ret €

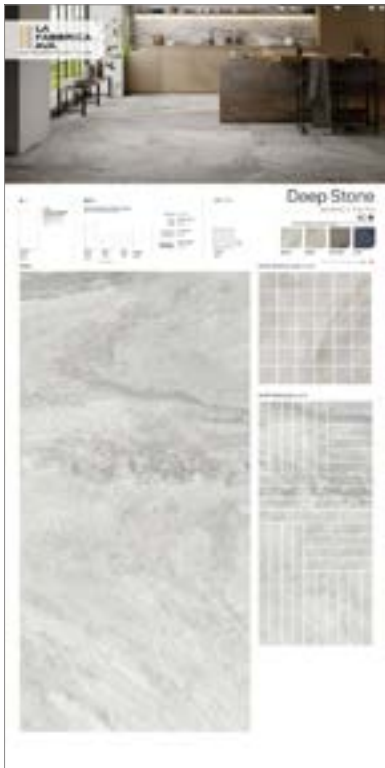

**Decori**

FDPS White 60x120 Lap Ret €  
 FDPS White 60x120 Nat Ret €



**Decori**

FDPS Beige 60x120 Lap Ret €  
 FDPS Beige 60x120 Nat Ret €

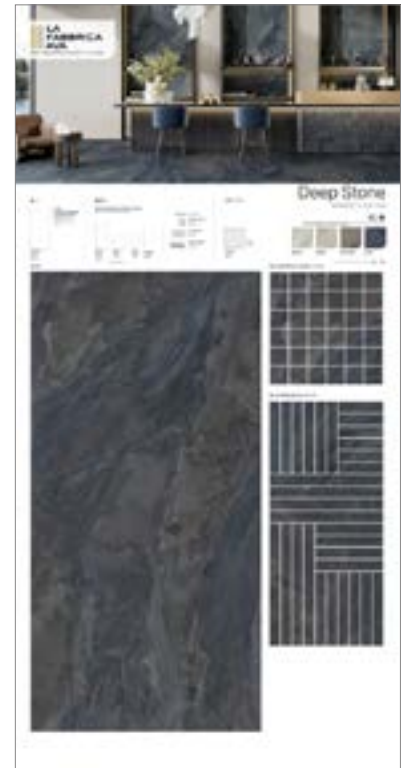

**Decori**

FDPS Blue 60x120 Lap Ret €  
 FDPS Blue 60x120 Nat Ret €

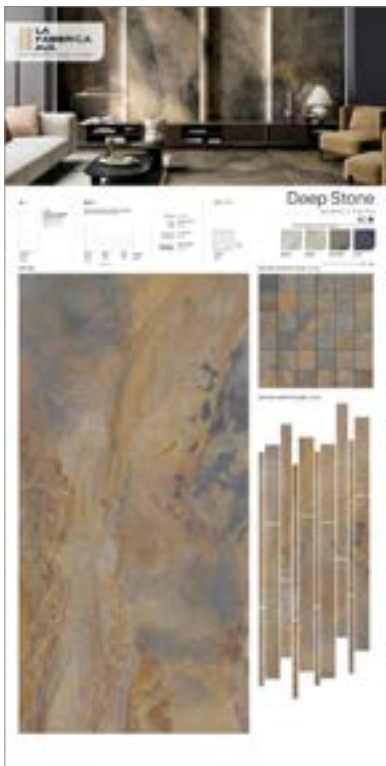

**Decori**

FDPS Natural 60x120 Lap Ret €  
 FDPS Natural 60x120 Nat Ret €

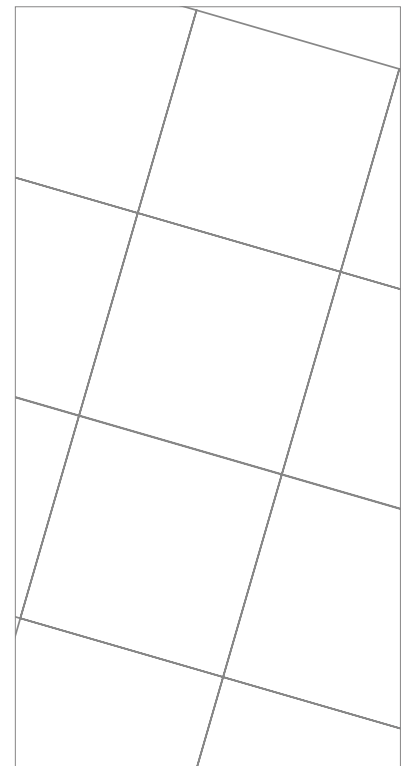

**Pannello Posato**

FDPS €/mq

## ESPOSITORI PER PIASTRELLE SINGOLE

SMALL DISPLAYS

FDPS06

200€

### KIT DEEP STONE 60x120

8 lastre 60x120

Tutte le lastre avranno dietro la grafica su retrocartone  
risvoltato con stampa applicata lucida  
formato 59 cm x117 cm

All panels will have graphics on the back with a folded  
backing board and applied glossy print,  
size 59 cm x 117 cm.



ES RETRO GRAFICA

White Nat Ret



Natural Nat Ret



Beige Nat Ret



Blue Nat Ret



White Lap Ret



Natural Lap Ret



Beige Lap Ret



Blue Lap Ret





FESL13

390€

### TOTEM LASTRE

**Totem centrosala singolo contenente 2 lastre 120x280**  
**Il prezzo si intende senza lastre**

Single center room totem contains 2 120x280 slabs  
The price is without slabs

## CARTELLE AGENTI DEEP STONE 60x60



FDPS04

33 €

WHITE 1 PZ 30x60 NAT + 1 PZ 30x60 LAP

BEIGE 1 PZ 30x60 NAT + 1 PZ 30x60 LAP

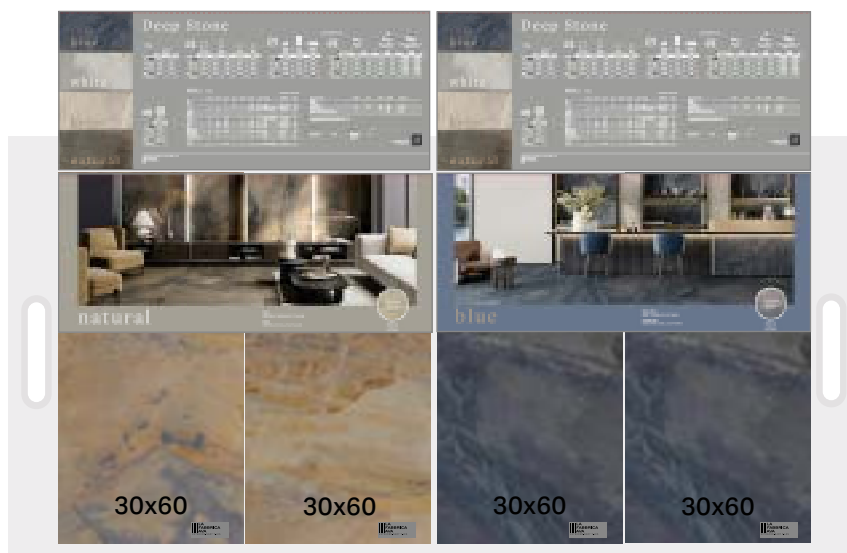

FDPS05

33 €

NATURAL 1 PZ 30x60 NAT + 1 PZ 30x60 LAP

BLUE 1 PZ 30x60 NAT + 1 PZ 30x60 LAP



# DEEP STONE

LAFABBRICAAVAMERCHANDISING2024



# DOLOMITI

LAFABBRICAAVAMERCHANDISING2024



## PANNELLI 100x200 SP 14 mm

BOARDS 100x200 THK 14 mm



### Sinottico

Calcite 60x120 Liscio Ret.

FDOL109 - 100x200

€ 75

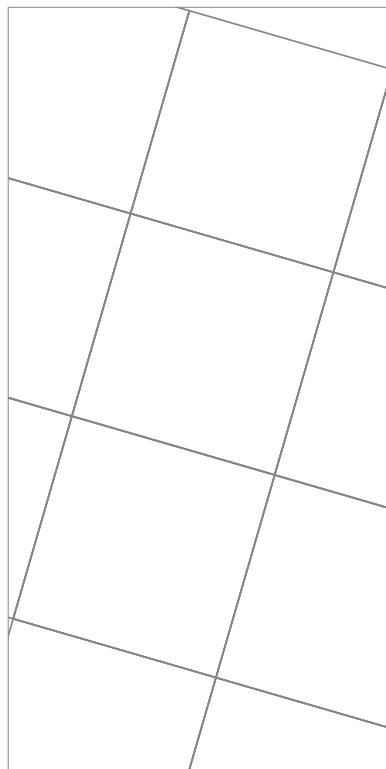

### Pannello Posato

FDOL02

€ 50/mq



CUL 86

170€

### CULLA DOLOMITI

Culla contenente 4 pannelli in MDF  
+ 3 piastrelle 60x120

Cradle contains 6 MDF panels  
+3 tiles 60x120

**FINO AD ESAURIMENTO SCORTE**  
AVAILABILITY LIMITED IN STOCKS

#### Set composition

Dimensioni pannelli  
panels sizes

60x90 cm



Cenere 60x60 Liscio Ret.

CP8602

Disponibile solo su richiesta  
Non compreso nella culla standard  
Available only on request  
It's not included in the standard  
cradle

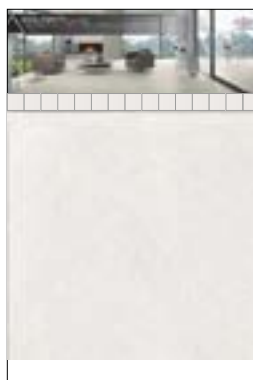

Calcite 60x60 Bocc. Ret.  
Mosaico Calcite

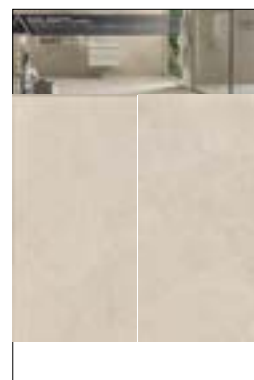

Sabbia 30x60  
Liscio Ret.



Basalto 60x60  
Liscio Ret.  
Mosaico Basalto

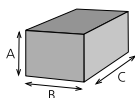

Espositore  
Display

A 160 cm

B 45 cm

C 80 cm

Kg 120



Calcite 60x120  
Liscio Lap. Ret.  
086003

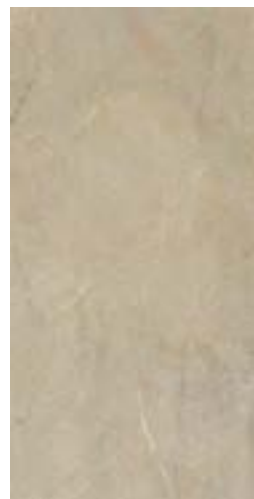

Sabbia 60x120  
Liscio Ret.  
086008



Cenere 60x120  
Liscio Ret.  
086013

# GEMSTONE

LAFABBRICA AVAMERCHANDISING 2024



LIBRO ARCHITETTI  
FOLDER



FGMS03

11€

FOLDER GEMSTONE





**Sinottico 1**  
Ocean 60x120 Lap Ret - FGMS25 - € 84,00  
Ocean 60x120 Nat Ret - FGMS24 - € 81,00

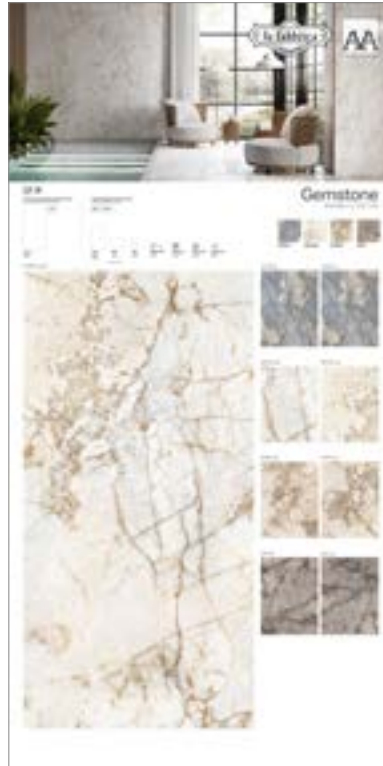

**Sinottico 2**  
Natural 60x120 Lap Ret - FGMS21 - € 84,00  
Natural 60x120 Nat Ret - FGMS20 - € 81,00



**Sinottico 3**  
Desert 60x120 Lap Ret - FGMS13 - € 84,00  
Desert 60x120 Nat Ret - FGMS12 - € 81,00



**Sinottico 4**  
Grey 60x120 Lap Ret - FGMS17 - € 84,00  
Grey 60x120 Nat Ret - FGMS16 - € 81,00

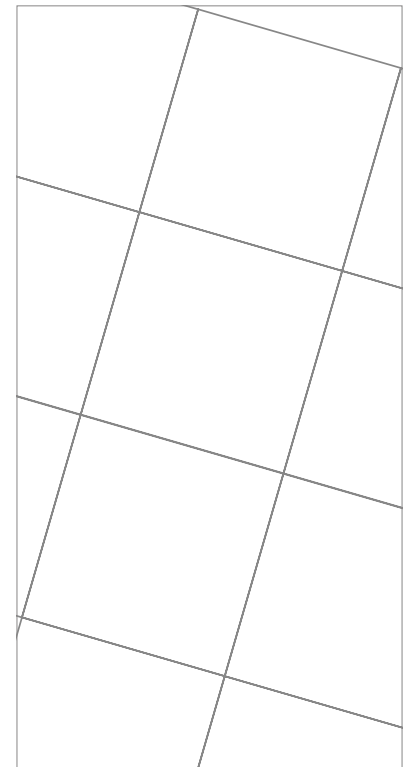

**Pannello Posato**  
FGMS02 € 85/mq

## PANNELLI 100x200 SP 14 mm

BOARDS 100x200 THK 14 mm



### Ocean Sinottico

Ocean 60x120 Lap Ret + decori - FGMS23 - € 100,00

Ocean 60x120 Nat Ret + decori - FGMS22 - € 98,00



### Natural Sinottico

Natural 60x120 Lap Ret + decori - FGMS19 - € 100,00

Natural 60x120 Nat Ret + decori - FGMS18 - € 98,00



### Desert Sinottico

Desert 60x120 Lap Ret + decori - FGMS11 - € 100,00

Desert 60x120 Nat Ret + decori - FGMS10 - € 98,00



### Grey Sinottico

Grey 60x120 Lap Ret + decori - FGMS15 - € 100,00

Grey 60x120 Nat Ret + decori - FGMS14 - € 98,00

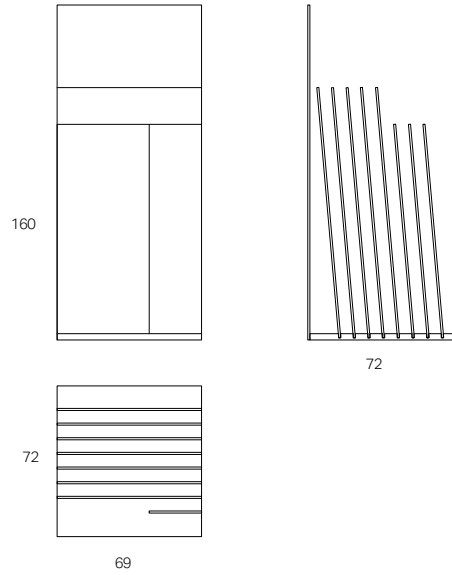

FGMS01

**250€**

**CULLA GEMSTONE**

Culla contenente 5 pannelli in MDF e 3 piastrelle 60x120.

Cradle contains 5 MDF panels and 3 tiles 60x120.

**Set composition**



Mosaici  
L20xH100 cm



Desert 60x60 Nat Ret  
Muretto Desert Nat Ret  
L64xH100 cm

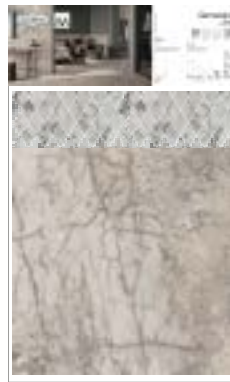

Grey 60x60 Nat Ret  
Rombo Grey Lap Ret  
L64xH100 cm



Natural 60x60 Nat Ret  
Natural 30x60 Nat Ret  
L64xH120 cm



Ocean 60x60 Nat Ret  
Ocean 30x60 Nat Ret  
L64xH120 cm



Ocean 60x120 Lap Ret  
L60xH120 cm



Grey 60x120 Lap Ret  
L60xH120 cm



Natural 60x120 Lap Ret  
L60xH120 cm



Pannello schiena  
L69xH160 cm

**ESPOSITORE GEMSTONE**  
DISPLAY FOR SINGLE TILES GEMSTONE

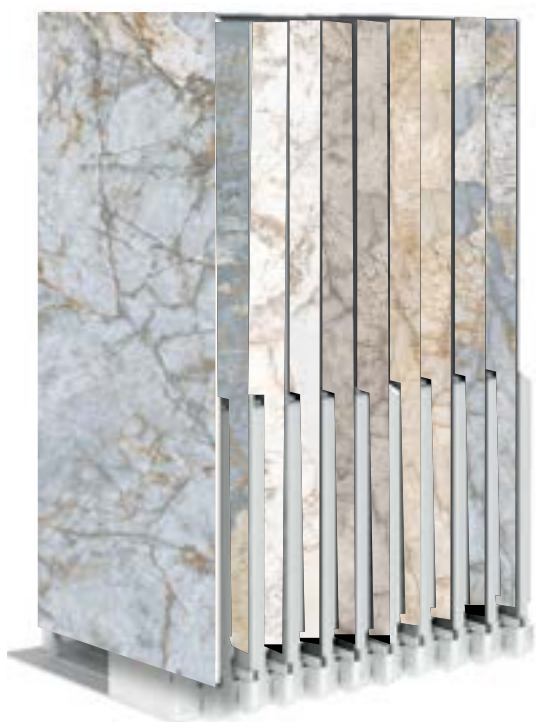

FGMS04

390€

**SET GEMSTONE 60x120**

Espositore scorrevole monofacciale per 10 lastre 60x120  
Exhibitor accomodating 10 front sliding slabs 60x120

Ocean Nat Ret



Ocean Lap Ret



Desert Nat Ret



Grey Nat Ret



Natural Nat Ret



Ocean Nat Ret



Ocean Lap Ret



Desert Lap Ret



Grey Lap Ret



Natural Lap Ret





## GRAFICA ESTERNA CARTELLA



## CARTELLE AGENTI 60x60

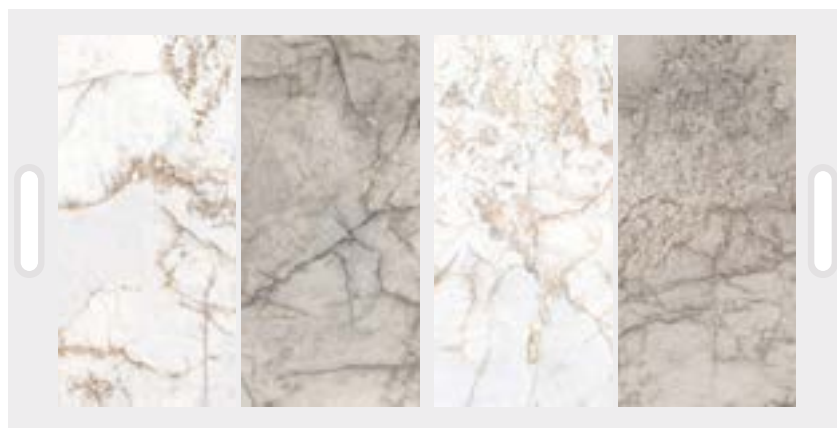

FGMS05

30€

### CARTELLA AGENTI A 60x60

1 PZ 30x60 NATURAL NAT  
1 PZ 30x60 GREY NAT

1 PZ 30x60 NATURAL LAP  
1 PZ 30x60 GREY LAP

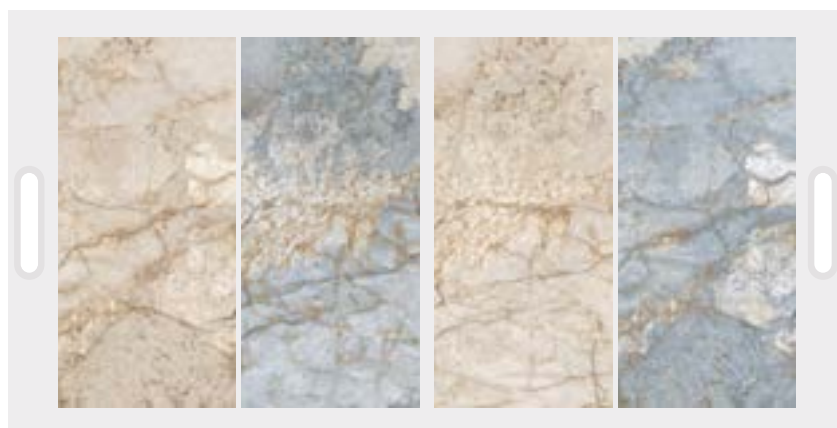

FGMS06

30€

### CARTELLA AGENTI B 60x60

1 PZ 30x60 DESERT NAT  
1 PZ 30x60 OCEAN NAT

1 PZ 30x60 DESERT LAP  
1 PZ 30x60 OCEAN LAP

FGMS07

180€

KIT GEMSTONE 60x120

8 Lastre 60x120  
8 slabs 60x120

Ocean Nat Ret



Desert Nat Ret



Grey Nat Ret



Natural Nat Ret



Ocean Lap Ret



Desert Lap Ret



Grey Lap Ret



Natural Lap Ret



ESPOSITORI PER PIASTRELLE SINGOLE ABBINABILI AL KIT FGMS07 GEMSTONE

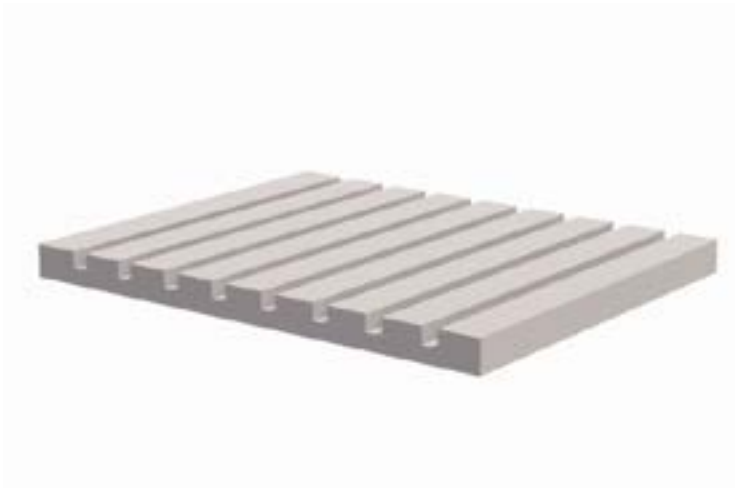

FBAS307

**31€**  
**BASE**

Espositore per piastrelle singole, contiene fino a 8 pz (sp 6-8,8-10 mm)  
Formato massimo 60x120 oppure 80x80

Display for single tiles, it contains up to 8 pcs (thk 6-8,8-10 mm)  
Maximum size 60x120 or 80x80

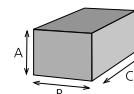

Espositore imballato vuoto  
*Packaged display (empty)*

A 4cm

B 62cm

C 72cm

Peso/Weight 6kg



FBAS407

**44€**  
**BASE PIANA 12 ALLOGGI SX e DX**

Espositore sinistro e destro per piastrelle/lastre singole  
contenente fino a 12 pz (sp da 6 a 11 mm). Formato  
massimo 80x160

Left and right display for single tiles/slabs. It contains up  
to  
12 pieces (thk from 6 mm to 11 mm). Maximun size 80x160

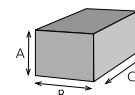

Espositore imballato (vuoto)  
*Packaged display (empty)*

A 8 cm

B 110 cm

C 67 cm

Peso/Weight 28,5 kg

# GROOVES

LA FABBRICA AVA MERCHANDISING 2024



CATALOGO  
CATALOG



FGRV00

1,2 €

CATALOGO GROOVES

FGRV03

15 €  
FOLDER GROOVES







**GROOVES - Technical specifications**  
ISO 15006 - EN 14411 - ISO 15045 Standards

Nominal sizes (mm) 5,2x20,7,5x15		Thickness (mm) 9 mm	
Style: Natural		Surface: matt, glossy	
Product Group: R10 (single channel)			
Technical characteristics	Test method	EN 14411 and ISO 15006 requirements	Substr Average values
Length accuracy	ISO 15045-2	±0.5% and ± 0.5mm	Compliant
Width accuracy	ISO 15045-2	±0.5% and ± 0.5mm	Compliant
Straightness of sides	ISO 15045-2	±0.5% and ± 1.5mm	Compliant
Rectangularity	ISO 15045-2	±0.5% and ± 2.0mm	Compliant
Flatness	ISO 15045-2	±0.5% and ± 0.5mm	Compliant
Thickness	ISO 15045-2	±0.5% and ± 0.5mm	Compliant
Moisture absorption	EN 15045-3	≤ 0.5%	Compliant
Modulus of rupture	ISO 15045-4	≥ 15 N/mm <sup>2</sup>	Compliant
Bending strength (D)	ISO 15045-4	≥ 200 N	Compliant
Thermal shock resistance	ISO 15045-6	No alterations	Resistant
Frost resistance	ISO 15045-12	No alterations	Resistant
Chemical resistance	ISO 15045-13	Declared value	LA - 10A
Fluorocarbon (CFR)	ISO 15045-13	0 mg	Compliant
Slip resistance	ISO 15045-14	Class 3 min.	Compliant
Wear resistance	EN 661-105	5 Min.	Compliant
Crack resistance	EN 12518-1	Not required	-
Fire reaction	EN 13501-1	-	A1-s1, d0
Thermal Conductivity	EN 12524	Not required	κ < 1,3 W/m·K
Light and colour fastness	EN 15006	Not required	No variations

LA FABBRICA AVA  
EXTRAORDINARY TILES

**SAGE**  
9 mm glossy

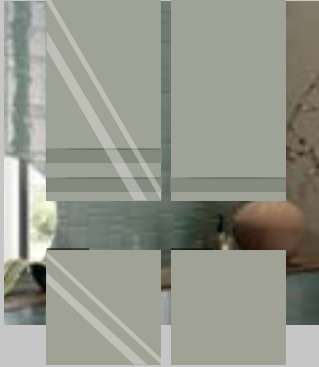

**SAGE**  
9 mm matta

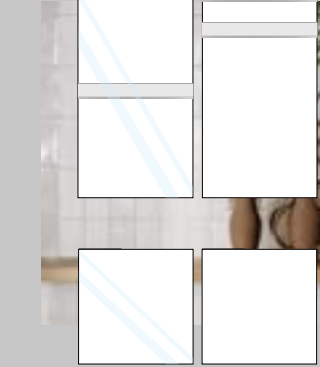

**WHITE**  
9 mm glossy

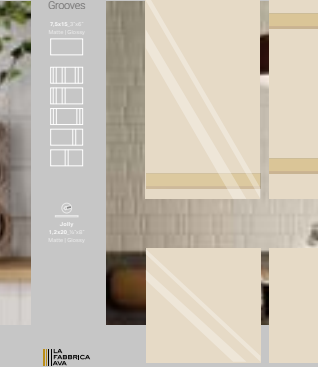

**WHITE**  
9 mm matta



**BONE**  
9 mm glossy



**BONE**  
9 mm matta



**GREY**  
9 mm glossy



**GREY**  
9 mm matta



GROOVES

1,5x15,7,5x9  
9 mm glossy

1,5x15,7,5x9  
9 mm matta

LA FABBRICA AVA  
EXTRAORDINARY TILES

SAGE

WHITE

BONE

GREY

FGRV04

76€  
 SET DA BANCO  
 GROOVES

SET DA BANCO GROOVES



- 1 base in mdf nobilitato bianco cm .33 x25 h4 a 4 incavi passanti da lato a lato
- 1 schiena in forex cm 43 x 33 x 0,5 cm con stampa in quadricromia solo fronte .
- 4 pannelli in forex bianco cm 33 x 23 x 0,5 cm con stampa fronte a 1 colore per 4 soggetti diversi e stampa in quadricromia sul retro a 4 soggetti diversi.
- 4 pannelli in forex bianco cm 33 x 8 x 0,5 cm con stampa fronte a 1 colore per 4 soggetti diversi e stampa in quadricromia sul retro a 4 soggetti diversi.

VISTA PIANA DEL SET DA BANCO

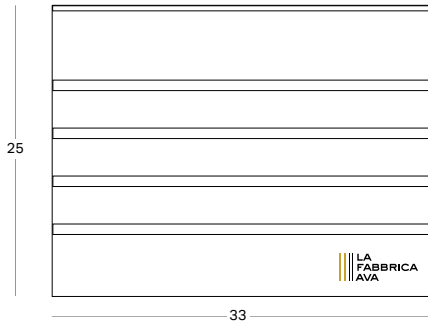

VISTA FRONTALE DEL SET A BANCO

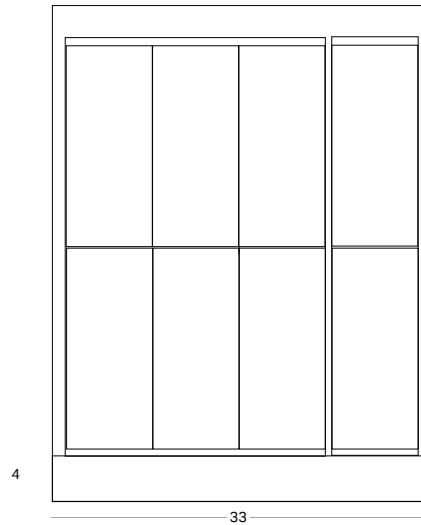

ES: POSA FRONTALE SU FOREX

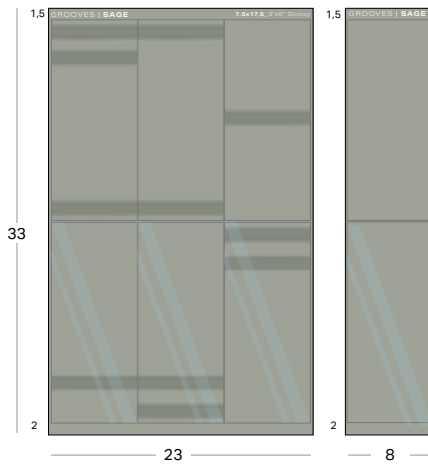

ES: POSSIBILE GRAFICA SUL RETRO



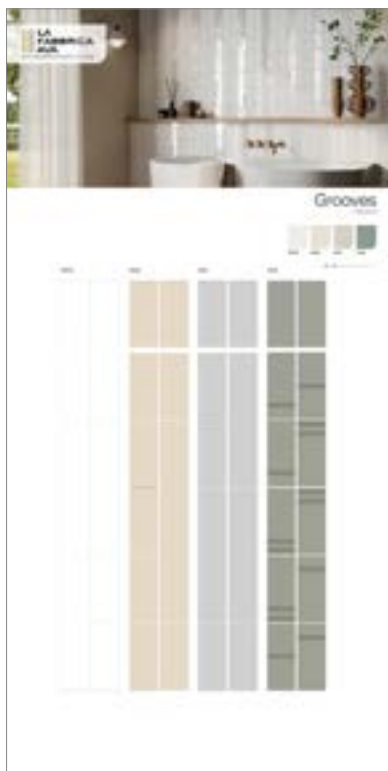

Sinottico 1  
FGRV05

80€

# HIGH LINE

LAFABBRICA AVAMERCHANDISING2024



**PANNELLI 100x200 SP 14 mm**

BOARDS 100x200 THK 14 mm

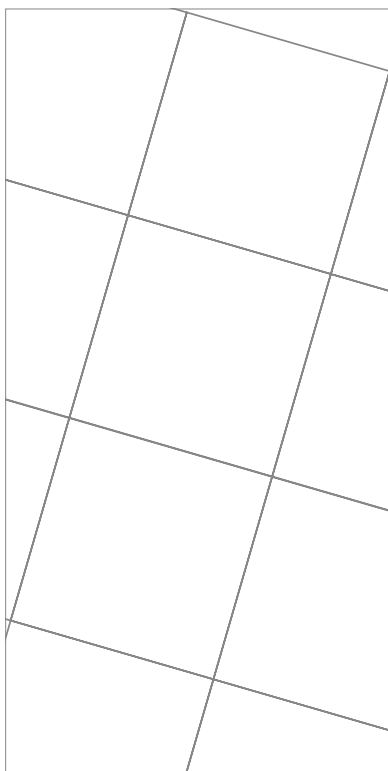

Pannello Posato

FHIL02

€ 50/mq





LIBRO ARCHITETTI  
FOLDER

FHNW03

20€

FOLDER HONEY WOOD



LARICE NAT

NOCE NAT

OLMO NAT

BRICOLA NAT

ROVERE NAT

ROVERE 6mm



FHNW04

**380 €**  
**SET HONEY WOOD CON PANNELLI**

Espositore scorrevole monofacciale per  
7 carrelli 60x151  
*Exhibitor accomodating whit 10 single-side sliding  
boards 60x151*

Espositore <i>Display</i>
A 157 cm
B 66 cm
C 58,8 cm
Kg

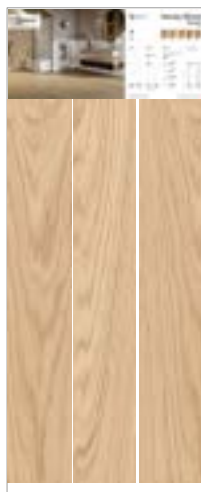
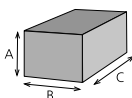

**ROVERE**  
20x120 Nat. Ret.



**OLMO**  
20x120 Nat. Ret.



**NOCE**  
20x120 Nat. Ret.

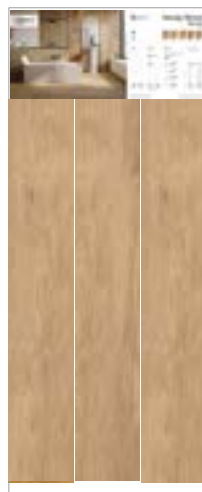

**BRICOLA**  
20x120 Nat. Ret.



**LARICE**  
20x120 Nat. Ret.

**Set composition**

Dimensioni pannelli  
*panels sizes*  
**60x151 cm**



**LARICE**  
30x120 Nat. Ret.



**LARICE**  
20x120 Nat. Ret. R11



FHNW05

**400 €**  
**CULLA HONEY WOOD 6 MM**

Culla contenente n. 7 pezzi

*Cradle containing 7*

- 24x240 ROVERE NAT
- 24x240 OLMO NAT
- 24x240 NOCE NAT
- 24x240 BRICOLA NAT
- 24x240 LARICENAT
- 40x240 BRICOLA NAT
- 40x240 LARICE NAT



Graphic banner

**Espositore**  
*Display*

A 140 cm

B 40 cm

C 65 cm

Kg

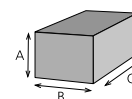

**CULLA**  
SET



FHNW18

**240€**

**CULLA HONEY WOOD DECORI**

Culla contenente n. 6 pannelli in MDF.

*Cradle containing 6 MDF panels.*

**FINO AD ESAURIMENTO SCORTE**

*AVAILABILITY LIMITED IN STOCKS*

Dimensioni pannelli  
*panels sizes*

40x143,5 cm



**CHEVRON**  
7,5x40,7 Nat.

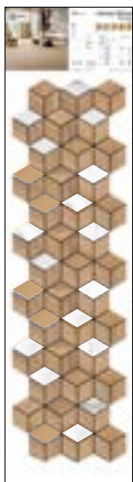

**ROMBO**  
30x35 Nat. Ret.



**INCISO**  
30x30 Nat. Ret.



**RIGATO**  
30x30 Nat. Ret.



**TAPPARELLA**  
20x120 Nat. Ret.  
listello Pierres Des Chateaux  
ha una posa random.



**SPINA**  
30x34 Nat. Ret.

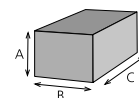

**Espositore**  
*Display*

A 147,5cm

B 40 cm

C 72 cm

Kg



FHNW20

190€

**CULLA HONEY WOOD NEW**  
Culla contenente n. 6 pannelli in MDF.  
*Cradle containing 6 MDF panels.*

**FINO AD ESAURIMENTO SCORTE**  
*AVAILABILITY LIMITED IN STOCKS*

Dimensioni pannelli  
*panels sizes*

40x143,5 cm



**CHEVRON**  
7,5x40,7 Nat.



**NOCE**  
20x120 Nat. Ret.



**ROVERE**  
20x120 Nat. Ret.



**LARICE**  
20x120 Nat. Ret.



**BRICOLA**  
20x120 Nat. Ret.



**OLMO**  
20x120 Nat. Ret.

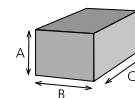

Espositore  
*Display*

A 147,5cm

B 40 cm

C 72 cm

Kg



Sinottico 5 Rovere

20x120 Nat. Ret.

FHNW16 100x200

75€



Sinottico Chevron

20x120 Nat. Ret.

FHNW17 100x200

95€

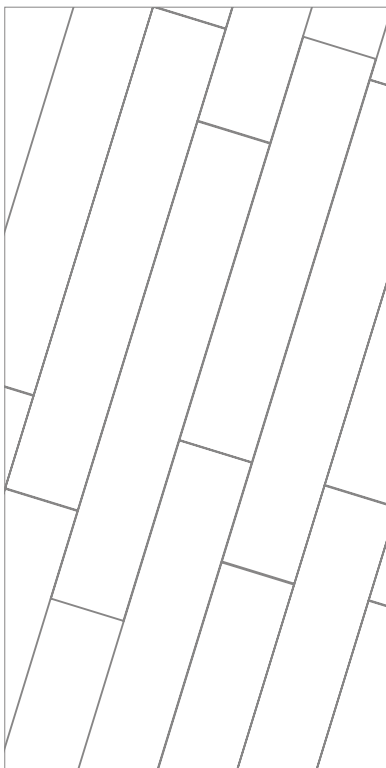

Pannello Posato

FHNW02 100X200

80€/mq



**Larice**  
20x120 Nat. Ret. - 30x120 Nat. Ret. + R11  
FHNW12 100x200 75€



**Noce**  
20x120 Nat. Ret. - 30x120 Nat. Ret. + R11  
FHNW13 100x200 75€



**Bricola**  
20x120 Nat. Ret. - 30x120 Nat. Ret. +R11  
FHNW11 100x200 75€



**Olmo**  
20x120 Nat. Ret. - 30x120 Nat. Ret. +R11  
FHNW14 100x200 75€



**Rovere**  
20x120 Nat. Ret. - 30x120 Nat. Ret. +R11  
FHNW15 100x200 75€

PER ORDINARE IL MOBILE OUTDOOR E' NECESSARIO INSERIRE 2 CODICI COME SEGUE :

inserire nell' ordine:

1 - il codice dell' espositore vuoto, completo di banner generico outdoor



2 - il codice di 2 pezzi Honey Wood 40x120 h20



191046



191046

3 - il codice del Banner Honeywood da inserire nell' espositore



FHNW19

18€  
BANNER OUTDOOR  
HONEYWOOD





TO ORDER OUTDOOR FURNITURE IT IS NECESSARY TO INSERT 2 CODES AS FOLLOWS:

insert in the order:

1 - the code of the empty exhibitor complete with generic outdoor banner



FESP14

270€  
MOBILE ESPOSITORE  
OUTDOOR + BANNER



2 - the code of the Honey Wood 40x120 h20 tile



191046



191046

3 - the code of Banner Honeywood



FHNW19

18€  
BANNER OUTDOOR  
HONEYWOOD





FHNW09

25 €  
**CARTELLA AGENTI A**  
**20x120**  
**HONEY WOOD**

contenente 20x120 naturale

*FINI ESAURIMENTO SCORTE*

**GRAFICA ESTERNA CARTELLA**

**KIT CARTELLE AGENTI 20x120**

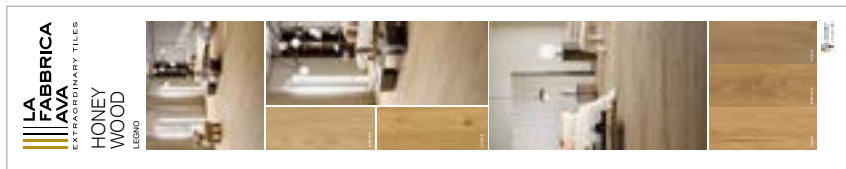

**HONEY WOOD**

2 PZ 20X120 ROVERE NAT  
LARICE NAT

+ PATELLA

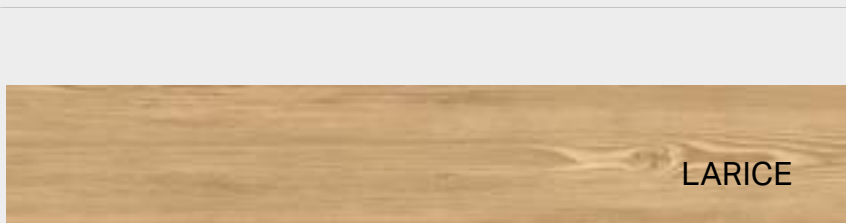
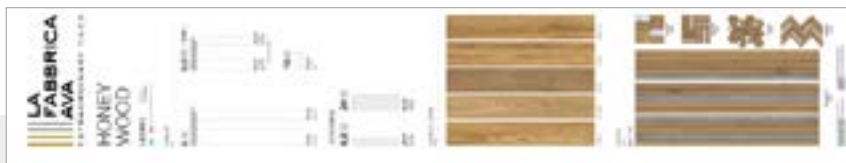



FHNW10

30 €  
CARTELLA AGENTI B  
20x120  
HONEY WOOD  
contenente 20x120 naturale

*FINI ESAURIMENTO SCORTE*

GRAFICA ESTERNA CARTELLA

KIT CARTELLE AGENTI 20x120



HONEY WOOD

3 PZ 20X120 NOCE NAT  
BRICOLA NAT  
OLMO NAT

# HURBAN

LAFABBRICA AVAMERCHANDISING 2024



## PANNELLI 100x200 SP 14 mm

BOARDS 100x200 THK 14 mm

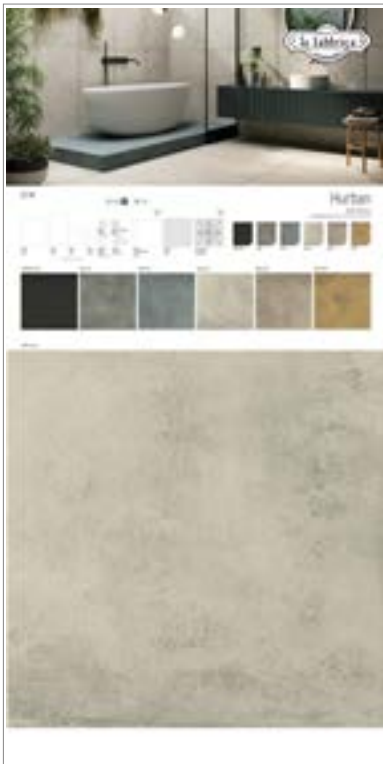

Sinottico  
White 100x100 Nat. Ret.

FHRB109  
132

€ 80

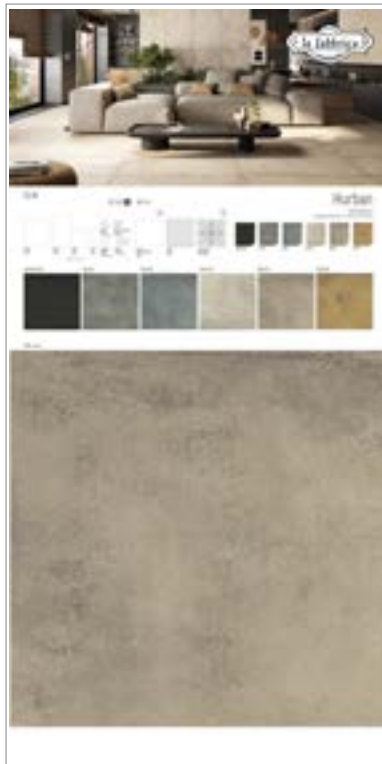

Sinottico  
Beige 100x100 Nat. Ret.

FHRB209

€ 80



Sinottico  
Gray 100x100 Nat. Ret.

FHRB309

€ 80



Sinottico  
Ocra 60x120 Nat. Ret.

FHRB409 €75



Sinottico  
Avio 60x120 Nat. Ret.

FHRB509 €75



Sinottico  
Graphite 60x120 Nat. Ret.

FHRB609 €75

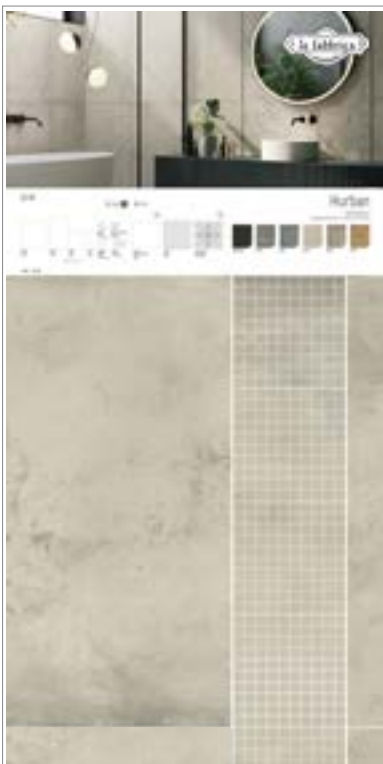

White  
White 60x120 Nat. Ret. -  
Mosaico Spaccatella Nat.Ret.

FHRB710 € 100



Beige  
Beige 60x120 Nat. Ret. -  
Quadrotto Intarsio Nat.Ret.

FHRB810 € 100



Gray  
Gray 60x120 Nat. Ret. - Mosaico Nat.Ret.-

FHRB910 € 90  
133

**PANNELLI 100x200 SP 14 mm**  
BOARDS 100x200 THK 14 mm

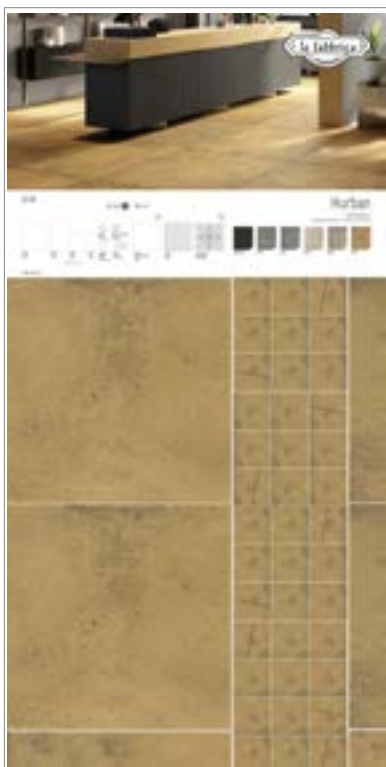

**Odra**  
Odra 60x60 Nat. Ret.  
Quadrotto Intarsio Nat.Ret.

FHR1010 € 100



**Avio**  
Avio 60x60 Nat. Ret. - Mosaico Nat.Ret.

FHR1110 € 70



**Graphite**  
Graphite 60x60 Nat. Ret. - Muretto Nat.  
Ret.

FHR1210 € 100

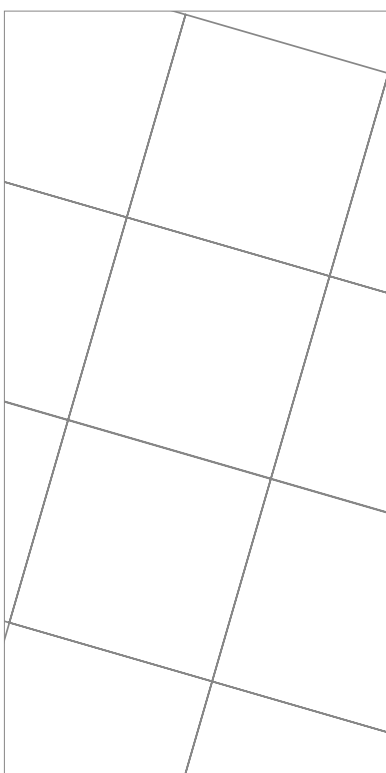

**Pannello Posato**

FHRB102 € 50/mq

**FINO AD ESAURIMENTO SCORTE**  
AVAILABILITY LIMITED IN STOCKS

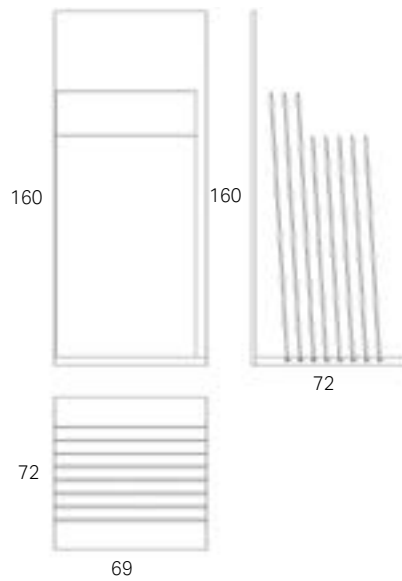

FHRB215

250€

**CULLA HURBAN**

Culla contenente n. 6 pannelli +  
2 pezzi 60x120

Cradle contains 6 panels +  
2 tiles thk 60x120

Set composition



White 60x60 Nat.Ret.  
Mosaico Spaccatella Nat.Ret.

L 64x H 100 cm



Beige 30x60 Nat.Ret.  
Muretto Nat.Ret.

L 64x H 100 cm



Ocra 60x60 Nat.Ret.  
Qudrotto Intarsio Nat.Ret.

L 64x H 100 cm



Avio 30x60 Nat.Ret.  
Mosaico Nat.Ret.

L 64x H 100 cm



Pannello schiena  
L 69x H 160 cm



Gray 60x60 Nat.Ret.  
Mosaico Spaccatella Nat.Ret.

L 64x H 100 cm



Graphite 30x60 Nat.Ret.  
Muretto Nat.Ret.

L 64x H 100 cm



Avio 60x120 Nat. Ret.

L 60x H 120 cm



Beige 60x120 Nat. Ret.

L 60x H 120 cm

Espositore imballato (vuoto)  
Packaged display (empty)

A 42 cm

B 127 cm

C 77 cm

Peso/Weight

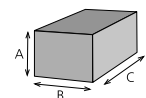

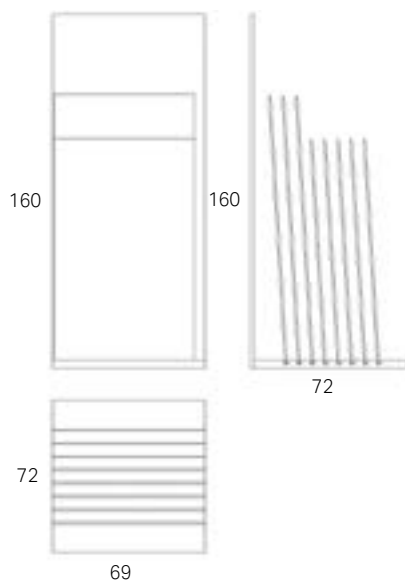

FHRB215

**250€**

**CULLA HURBAN**

Culla contenente n. 6 pannelli +  
2 pezzi 60x120

Cradle contains 6 panels +  
2 tiles thk 60x120

**Set composition**



White 60x60 Nat.Ret.  
Mosaico Spaccatella Nat.Ret.

L 64xH 100 cm



Beige 60x60 Nat.Ret.  
Muretto Nat.Ret.

L 64xH 100 cm



Ocra 60x60 Nat.Ret.  
Qudrotto Intarsio Nat.Ret.

L 64xH 100 cm

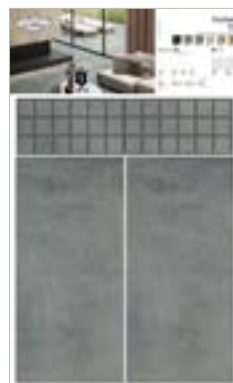

Avio 30x60 Nat.Ret.  
Mosaico Nat.Ret.

L 64xH 100 cm



**Pannello schiena**  
L 69xH 160 cm



Gray 60x60 Nat.Ret.  
Mosaico Spaccatella Nat.Ret.

L 64xH 100 cm



Graphite 60x60 Nat.Ret.  
Muretto Nat.Ret.

L 64xH 100 cm



Avio 60x120 Nat. Ret.

L 60xH 120 cm



Beige 60x120 Nat. Ret.

L 60xH 120 cm

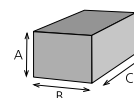

Espositore imballato (vuoto)  
Packaged display (empty)

A 42 cm

B 127 cm

C 77 cm

Peso/Weight





FESP02

170€

### ESPOSITORE A TIRO 100x100

Espositore scorrevole monofacciale per 6 lastre 100x100  
Exhibitor accomodating 6 single-side sliding slabs 100x100



FHRB124

190€

**KIT 5 PEZZI**  
100x100 HURBAN



Graphite100x100 Nat. Ret.



Gray 100x100 Nat. Ret.



Avio 100x100 Nat. Ret.



White 100x100 Nat. Ret.



Beige 100x100 Nat. Ret.



Ocra 100x100 Nat. Ret.

## KIT CARTELLA AGENTI HURBAN

AGENTS SAMPLE BOARDS



GRAFICA ESTERNA CARTELLA

FAGHURB

45€

KIT 2 CARTELLE AGENTI A 60x60



## ESPOSITORE OUTDOOR

OUTDOOR SOLUTION



FHRB01

440€

ESPOSITORE OUTDOOR

HURBAN + kit outdoor + banner

220x100 cm.

- 1 PZ 100x100 DECORO QUEENS BEIGE 20 mm
- 1 PZ 100x100 WHITE NAT 20 mm
- 4 PZ 20x20 OCRA NAT 20 mm
- AVIO NAT 20 mm
- GRAY NAT 20 mm
- GRAPHITE NAT 20 mm

220

80



100



FINO AD ESAURIMENTO SCORTE

AVAILABILITY LIMITED IN STOCKS



FHRB05

80 €

**SET DA BANCO**

6 PEZZI 6MM 30x70

- GRAPHITE NAT
- GRAY NAT
- AVIO NAT
- WHITE NAT
- BEIGE NAT
- OCRA NAT

**FINO AD ESAURIMENTO SCORTE**  
*AVAILABILITY LIMITED IN STOCKS*

**CARTELLA 20mm**  
BOARDS H20



FHRB128

9,5€

**CARTELLA 20MM 56x65**

6 PEZZI 20MM

- GRAPHITE NAT
- GRAY NAT
- AVIO NAT
- WHITE NAT
- BEIGE NAT
- OCRA NAT

A COMPLEMENTO DI FBAS07

**FINO AD ESAURIMENTO SCORTE**  
*AVAILABILITY LIMITED IN STOCKS*

# I QUARZI

LAFABBRICAAVAMERCHANDISING2024





**Sinottico**

Prasio 30x60 Nat. Ret. R11  
Prasio 60x60 Nat. Ret. R11  
FQUA109 - 100x200

€ 55

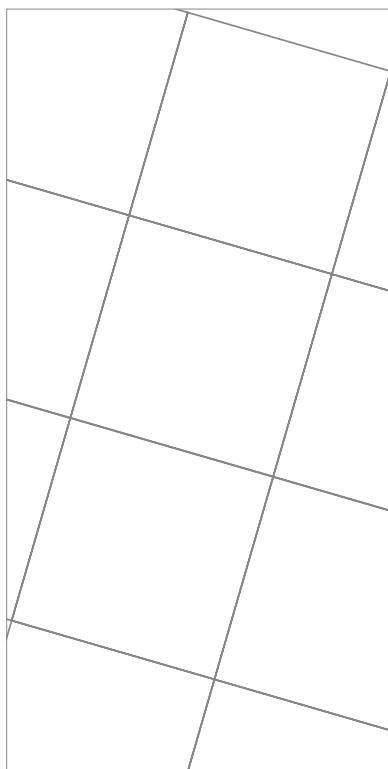

**Pannello Posato**

FQUA02

€ 50/mq

**CARTELLA I QUARZI**  
SAMPLE BOARDS



FQUA03

25€

**CARTELLA 80x85**  
**I QUARZI**

DIASPRO 20,3x40,6 R11  
MADERA 20,3x40,6 R11  
PRASIO 20,3x40,6 R11

**FINO AD ESAURIMENTO SCORTE**  
AVAILABILITY LIMITED IN STOCKS

# IL CERRETO

LAFABBRICA AVAMERCHANDISING 2024



## PANNELLI 100x200 SP 14 mm

BOARDS 100x200 THK 14 mm



### Decoro Chrome

60x120 Nat. Ret.

FCER109 - 100x200

€ 60



### Sinottico 1

Chardonnay 23x149 Nat. Ret.

FCER209 - 100x200

€ 70

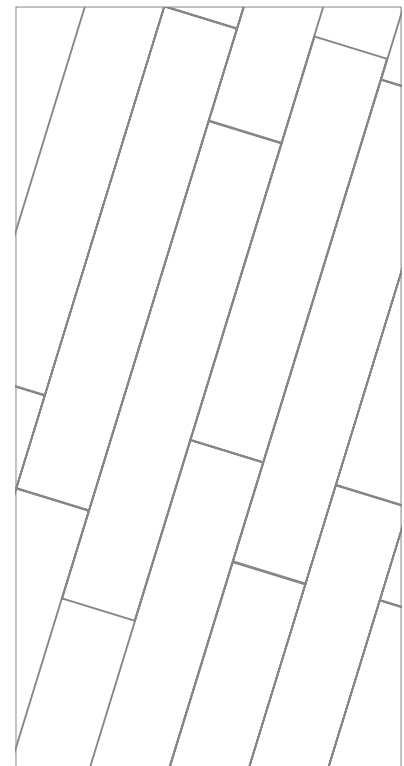

### Pannello Posato

FCER02

€ 50/mq



FCER115

**250€**

**CULLA IL CERRETO**

Culla contenente n. 7 pannelli + 5 piastrelle  
23x149

Cradle contains 7 panels + 5 tiles thk 23x149

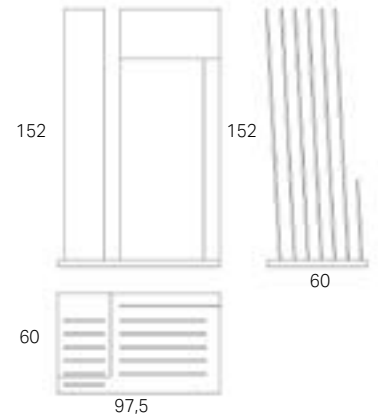

**FINO AD ESAURIMENTO SCORTE**  
AVAILABILITY LIMITED IN STOCKS



Outdoor  
L 50x H 32 cm



Pinot Grigio  
23x149  
Nat. Ret.

Champagne  
23x149  
Nat. Ret.

Amarone  
23x149  
Nat. Ret.

Soave  
23x149  
Nat. Ret.

Chardonnay  
23x149  
Nat. Ret.

**Set composition**

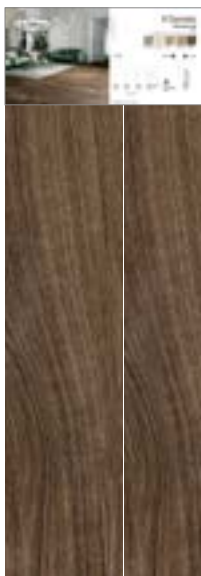

Amarone  
20-30x120 Nat. Ret.  
L 50x H 150 cm



Soave  
20-30x120 Nat. Ret.  
L 50x H 150 cm



Chardonnay  
20-30x120 Nat. Ret.  
L 50x H 150 cm



Pinot grigio  
20-30x120 Nat. Ret.  
L 50x H 150 cm



Champagne  
20-30x120 Nat. Ret.  
L 50x H 150 cm

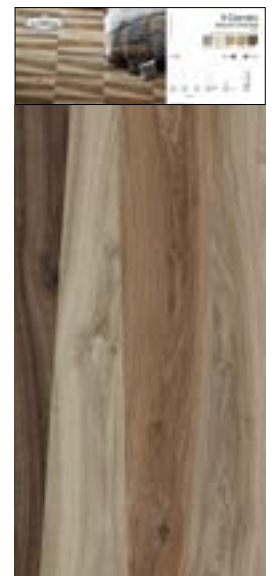

Decoro Chrome  
60x120 Nat. Ret.  
L 70x H 150 cm

# IMAGINE

LAFABBRICAAVAMERCHANDISING2024





**SET DA BANCO**  
DISPLAY CUT TILES SAMPLE CASE



FIMGN26

**200€**

**SET DA BANCO 6mm - 8,8 mm**

18 TOZZETTI 6 mm - 8,8mm

Set contenente tozzetti sp 6 mm - 8,8mm 15x30

Set contains tile thk 6 mm - 8,8mm 15x30

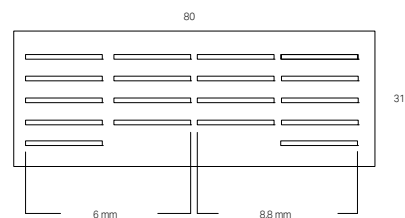

**SCATOLA PORTA TOZZETTI IMAGINE**

DISPLAY CUT TILES SAMPLE CASE



FIMGN27

**160€**

**SCATOLA PORTA TOZZETTI**

Scatola contenente tozzetti sp 6 mm o 8,8 mm

Max 18 pz 15x30

9 PZ sp 6 mm

9 PZ sp 8,8 mm

Box contains tile thk 6 mm or 8,8 mm

Max 18 pieces 15x30

# IMPERIAL

LAFABBRICA AVAMERCHANDISING 2024



**PANNELLI 100x200 SP 14 mm**  
BOARDS 100x200 THK 14 mm



**Sinottico 1**  
Navona 60x120 Nat. Ret.  
FIM109 - 100x200 € 60



**Sinottico 2**  
Alabastrino 60x120 Lap. Ret.  
FIM209 - 100x200 € 60

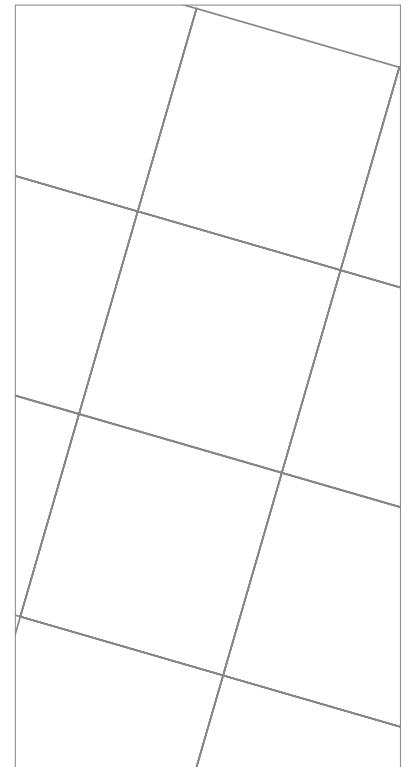

**Pannello Posato**  
FIMP02 € 50/mq



**PANNELLI 100x200 SP 14 mm**  
BOARDS 100x200 THK 14 mm



**Sinottico 1**  
Bone 60x120 Nat. Ret.  
FJU109 - 100x200 € 80

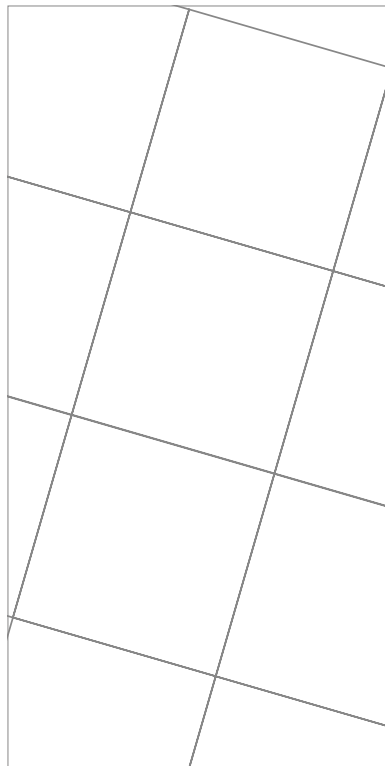

**Pannello Posato**  
FJU02 € 50/mq

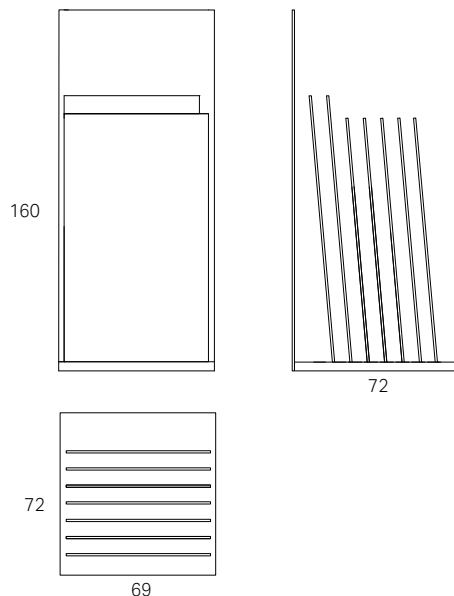

FJU0215

260€

**CULLA JUNGLE STONE**

Culla contenente n. 5 pannelli + 2 piastrelle 60x120  
Cradle contains 5 panels + 2 tiles thk 60x120

**FINO AD ESAURIMENTO SCORTE**  
AVAILABILITY LIMITED IN STOCKS

Set composition



Silver 30x60 Lap. Ret.  
30x60 Nat. Ret.  
Intreccio Silver Nat. Ret.  
L 64xH 110 cm



Gravel 30x60 Lap. Ret.  
30x60 Nat. Ret.  
Spina di pesce Nat. Ret.  
L 64xH 110 cm



Bone 10x30 Nat. Ret.  
L 64xH 110 cm



**Crowner**  
L 69x H 160 cm

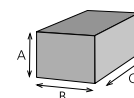

Espositore imballato (vuoto)  
Packaged display (empty)

A 42 cm

B 163 cm

C 83 cm

Peso/Weight



Desert 60x60 Lap. Ret.  
Esagona Nat. Ret.  
L 64xH 110 cm



Wild 60x60 Nat. Ret.  
Muretto Nat. Ret.  
L 64xH 110 cm



Bone 60x120 Lap. Ret.



Desert 60x120 Nat. Ret.



**PANNELLI 100x200 SP 14 mm**  
 BOARDS 100x200 THK 14 mm



**Sinottico 1**  
 Tasman 20x120 Lap. Ret.  
 FKAU109 - 100x200 € 75

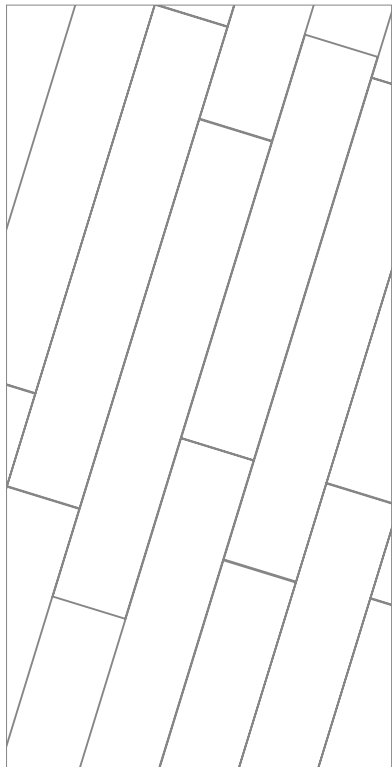

**Pannello Posato**  
 FKAU02 € 50/mq

# LE MALTE

LAFABBRICA AVA MERCHANDISING 2024



**SCATOLA PORTA TOZZETTI**  
DISPLAY CUT TILES SAMPLE CASE

FMLT04

22€

## SCATOLA LE MALTE

Contenente 6 tozzetti 10X20 6mm  
con applicata tampa adesiva sul retro della pistrella

Containing 6 tile samples 10x20 6mm  
with adhesive backing applied on the back of the tile



Taupe



Taupe

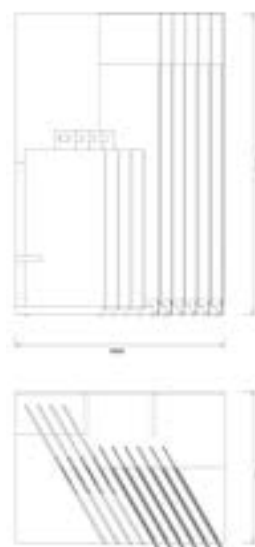

FMLT01

430€  
**CULLA LE MALTE**

contenete  
4 pz di 80x80 cm 8,8 mm con maniglia  
6 pz di 60x120 cm 6mm  
montati su carrelli estraibili  
con grafica applicata su pannello di misura  
60x1450x3mm

Set Composition

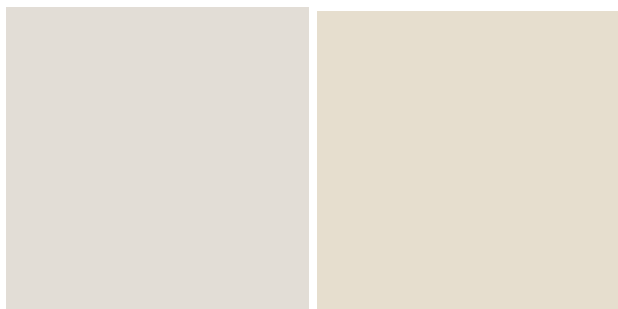

Ivory 80x80 Nat.Ret.

Beige 80x80 Nat.Ret.

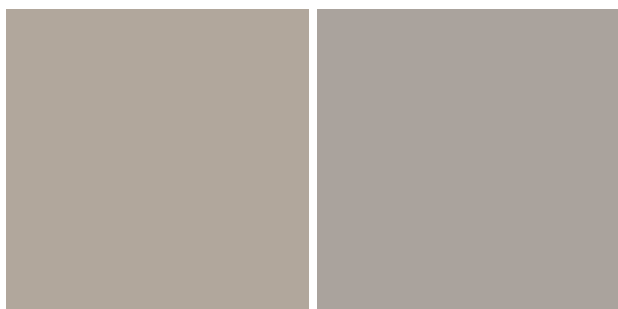

Taupe 80x80 Nat.Ret.

Grey 80x80 Nat.Ret.

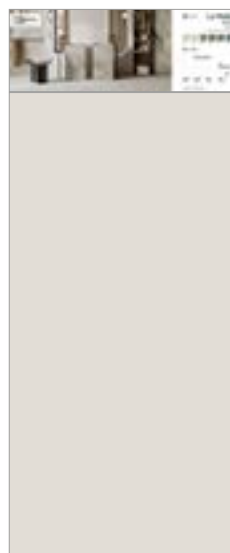

Ivory 60x120 Nat.Ret.



Avio 60x120 Nat.Ret.



Sage 60x120 Nat.Ret.

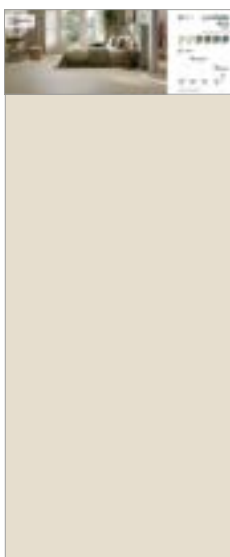

Beige 60x120 Nat.Ret.



Taupe 60x120 Nat.Ret.



Grey 60x120 Nat.Ret.

## ESPOSITORI PER PIASTRELLE SINGOLE

SMALL DISPLAYS

---

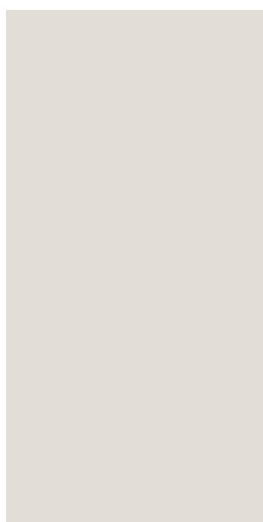

Ivory

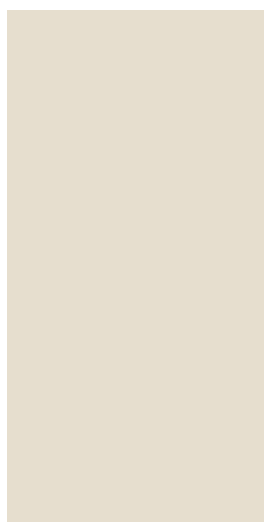

Beige

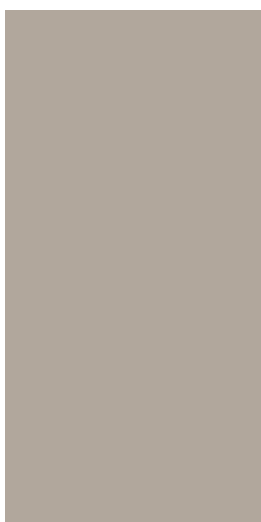

Taupe

FMLT05

110 €

### KIT 60x120

6 lastre 60x120

Tutte le lastre avranno dietro la grafica su retrocartone  
risvoltato con stampa applicata lucida

con bachelta plexy

formato 59 cm x117 cm

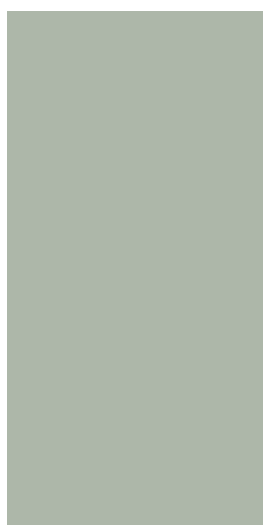

Sage

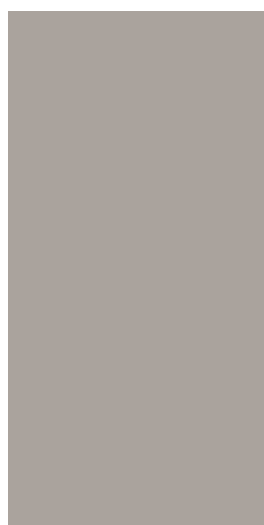

Grey

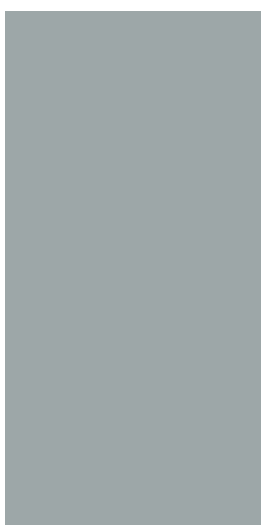

Avio



ES GRAFICA





Beige  
FMLT09 100,00 €



Taupe  
FMLT13 100,00 €



Gray  
FMLT010 100,00 €



Ivory  
FMLT11 100,00 €



Avio  
FMLT08 100,00 €



Sage  
FMLT12 100,00 €

## PANNELLI 100x200 SP 14 mm

BOARDS 100x200 THK 14 mm

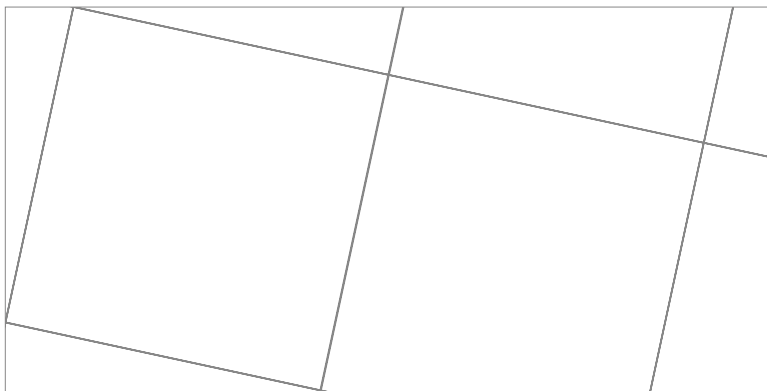

Pannello Posato

FMLT02

€80/mq

## CARTELLA AGENTI

SAMPLE BOARD

### KIT 4 CARTELLE AGENTI 60x60

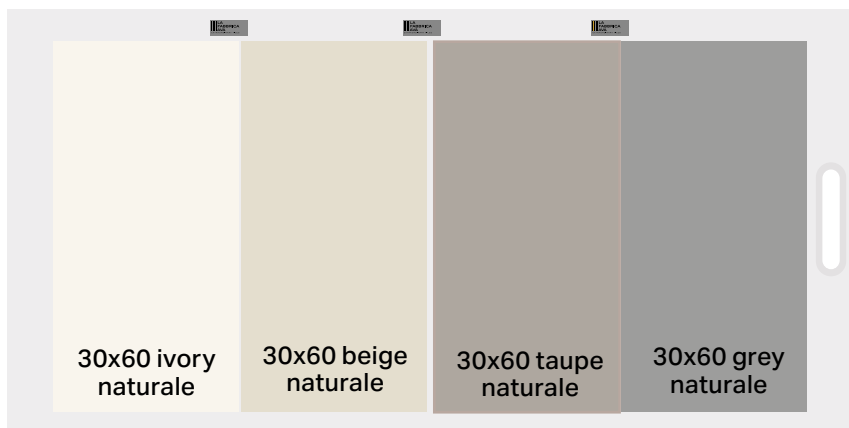

30x60 ivory  
naturale

30x60 beige  
naturale

30x60 taupe  
naturale

30x60 grey  
naturale

FMLT06

36 €

### CARTELLA AGENTI LE MALTE 6mm 60x60

1 PZ 30x60 IVORY NAT  
1 PZ 30x60 BEIGE NAT  
1 PZ 30x60 TAUPE NAT  
1 PZ 30x60 GREY NAT



30x60sage  
naturale

30x60avio  
naturale

FMLT07

36 €

### CARTELLA AGENTI LE MALTE 6mm 60x60

1 PZ 30x60 SAGE NAT  
1 PZ 30x60 AVIO LAP

1 ADESIVO GRAFICO 60x60 CM

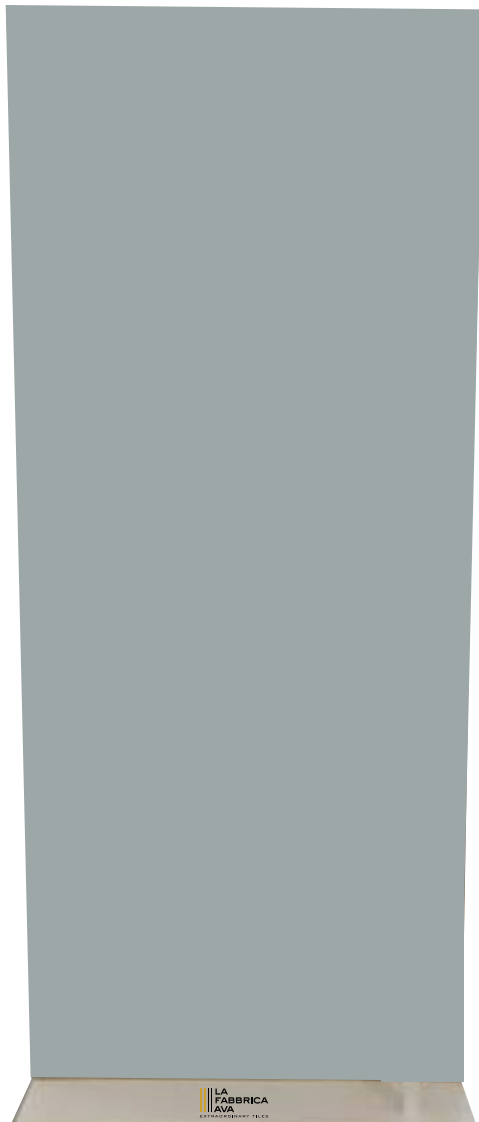

FESL13

390€

### TOTEM LASTRE

**Totem centrosala singolo contenente 2 lastre 120x280**  
**Il prezzo si intende senza lastre**

Single center room totem contains 2 120x280 slabs  
The price is without slabs



## PANNELLI 100x200 SP 14 mm

BOARDS 100x200 THK 14 mm



### Sinottico 1

Kimberly 60x120 Lap. Ret.

FLAX109 - 100x200

€ 70

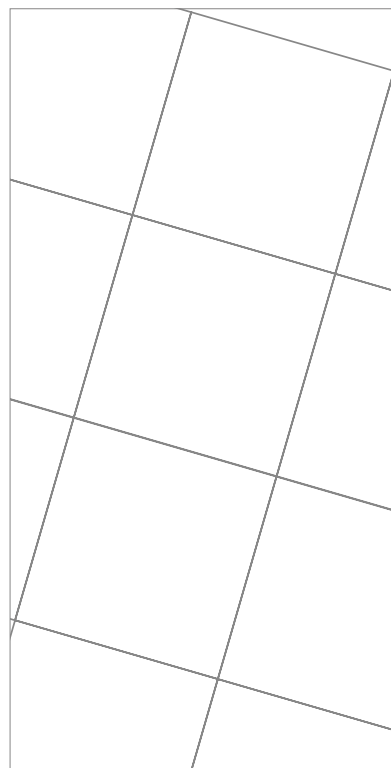

### Pannello Posato

FLASC02

€ 50/mq

**FINO AD ESAURIMENTO SCORTE**  
*AVAILABILITY LIMITED IN STOCKS*



CUL89M

220 €

CULLA LASCAUX MAXY

FINO AD ESAURIMENTO SCORTE  
AVAILABILITY LIMITED IN STOCKS

Dimensioni pannelli / panels sizes 30x151h cm - 60x151h cm



Capri Lap. Ret.  
30x120

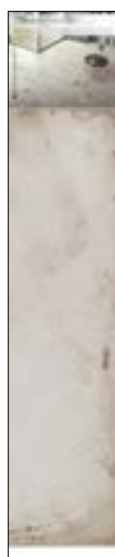

Capri Nat. Ret.  
30x120



Ellison Lap. Ret.  
30x120



Ellison Nat. Ret.  
30x120



Jeita Lap. Ret.  
30x120



Jeita Nat. Ret.  
30x120



Kimberly Lap. Ret.  
30x120



Kimberly Nat. Ret.  
30x120



Naxa Lap. Ret.  
30x120



Naxa Nat. Ret.  
30x120



Kimberly Lap. Ret.  
60x120

Espositore Display
A 170 cm
B 64 cm
C 60 cm
Peso 155 kg

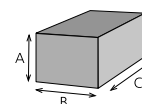

# MACCHIA ANTICA

LAFABBRICA AVAMERCHANDISING 2024



## PANNELLI 100x200 SP 14 mm

BOARDS 100x200 THK 14 mm



**FMAC109** € 70 MACCHIA ANTICA NAT  
**FMAC209** € 80 MACCHIA ANTICA LAP



CULLA  
SET



CUL140

210 €

CULLA METAL

FINO AD ESAURIMENTO SCORTE  
AVAILABILITY LIMITED IN STOCKS

# NAUTILUS

LA FABBRICA AVAMERCHANDISING 2024





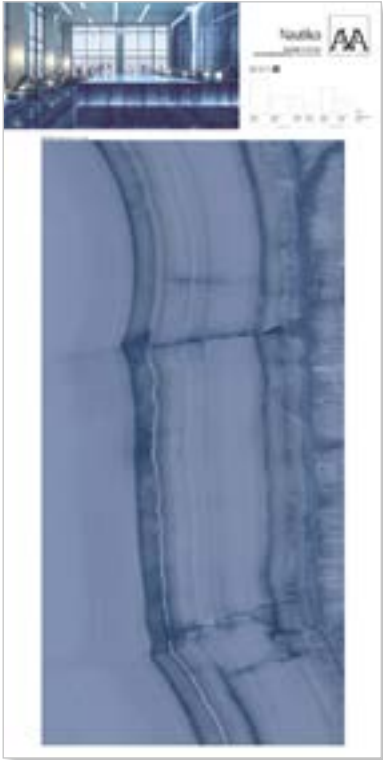

**FNTL01**

**€ 120** NAUTILUS LAP

# NOBLE STONE

LAFABBRICA AVAMERCHANDISING 2024



## LIBRO ARCHITETTI

FOLDER

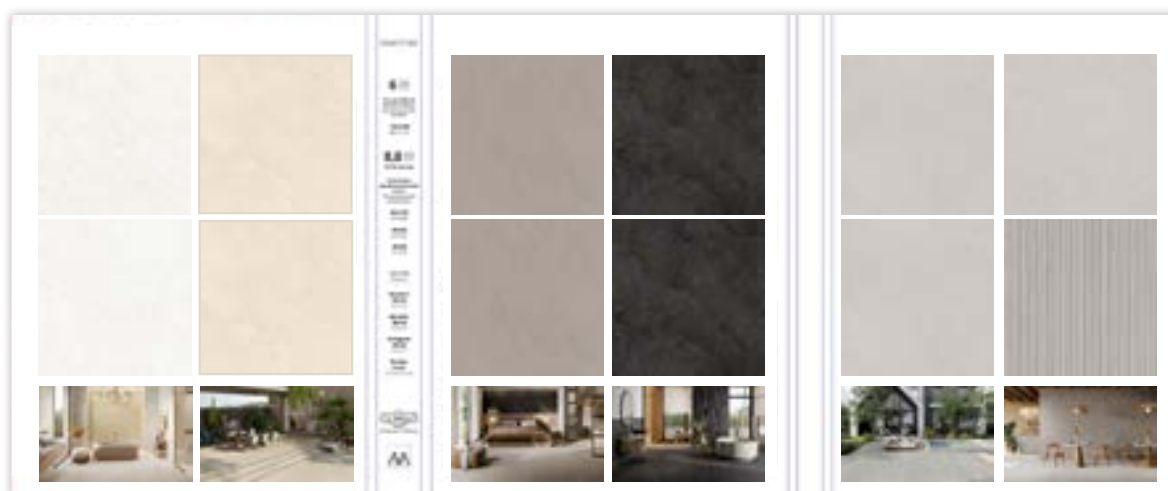

FNBS03

11€

FOLDER 8,8 mm

1 PZ WHITE NAT  
1 PZ WHITE 3D SATIN  
1 PZ BEIGE NAT  
1 PZ BEIGE 3D SATIN

1 PZ TAUPE NAT  
1 PZ TAUPE 3D SATIN  
1 PZ DARK NAT  
1 PZ DARK 3D SATIN

1 PZ GREY NAT  
1 PZ GREY 3D SATIN  
1 PZ GREYR11  
1 PZ GREY 3D STRIPES

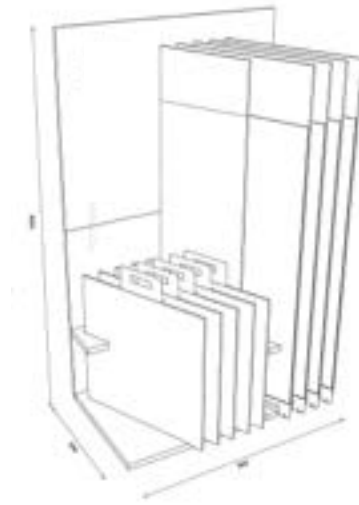

FNBS01

440€

**CULLA NOBLE STONE**

contenete  
5 pz di 60x60 cm 8,8 cm con maniglia  
4 pz di 60x120 cm 8,8 cm  
con grafica applicata su pannello in pvc  
di misura 60x1450x3mm  
montati su carrelli estraibili  
  
1 pannello decori  
1 pannello riepilogativo 60x145 montato  
su carrello estraibile

Set Composition



Grey 60x60  
Nat. Ret.



Dark 60x60  
Nat. Ret.



White 60x60  
Nat. Ret.

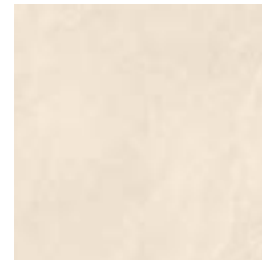

Beige 60x60  
Nat. Ret.



Taupe 60x60  
Nat. Ret.



Basket Beige  
30x30 Nat.Ret.

Mosaico  
Modulo Taupe  
30x30 Nat.Ret.

Muretto Dark  
30x60 Nat.Ret.

Pannello decori



Beige 60x120  
3D Satin. Ret.



Beige 60x120  
3D Stripes Ret.



Beige 60x120  
Nat Ret.

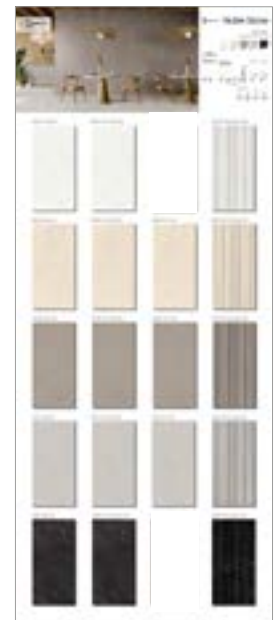

PANNELLO  
RIEPILOGATIVO

ARTICOLI VERSIONE 9 GESTITI AL PEZZO DA ABBINARE AL FESP02

100 x100 FOR FESP02



White 100x100 Nat. Ret.  
cod. 199071



Beige 100x100 Nat. Ret.  
cod. 199073

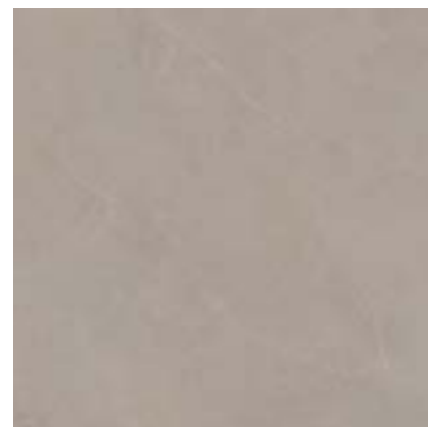

Taupe 100x100 Nat. Ret.  
cod. 199075



Grey 100x100 Nat. Ret.  
cod. 199072



Dark 100x100 Nat. Ret.  
cod. 199074



FESP02

180€

**ESPOSITORE A TIRO 100x100**

Espositore scorrevole monofacciale per 6 lastre 100x100

Exhibitor accomodating 6 single-side sliding slabs 100x100



White 120x120 Nat. Ret.  
cod. 199091



Beige 120x120 Nat. Ret.  
cod. 199093



Taupe 120x120 Nat. Ret.  
cod. 199095



Grey 120x120 Nat. Ret.  
cod. 199092



Dark 120x120 Nat. Ret.  
cod. 199094



FESL12

950€

### TWISTER 120x120

Espositori a 5 carrelli bifacciali scorrevoli  
e girevoli a 180°

Richiedere il pannello F00120  
con l'utilizzo di piastrelle spessore 6mm  
o da abbinare ai pannelli posati

Exhibitors with 5 double-sided sliding and  
180° rotating trolleys  
Request panel F00120  
with the use of 6mm thick tiles  
or to combine with the laid panels

## ESPOSITORI PER PIASTRELLE SINGOLE

SMALL DISPLAYS

FNBS04

260€

### KIT 60x120

10 lastre 60x120

Tutte le lastre avranno dietro la grafica su retrocartone  
risvoltato con stampa applicata lucida  
formato 59 cm x117 cm

senza bachelta plexy



ES GRAFICA  
RETRO CARTONATO

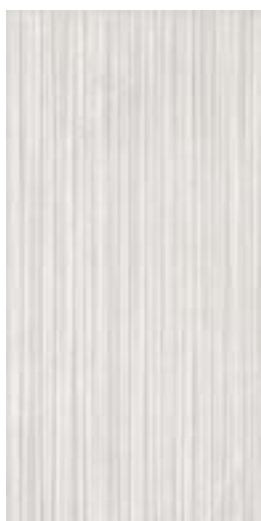

3D Stripes White  
60x120 Ret.



Beige 60x120  
3D Satin. Ret.



Taupe 60x120  
3D Satin. Ret.



3D Stripes Taupe  
60x120 Ret.



Taupe 60x120  
R11 Ret.



White 60x120 Nat. Ret.



Beige 60x120 Nat. Ret.



Gray 60x120 Nat. Ret.



Taupe 60x120 Nat. Ret.



Dark 60x120 Nat. Ret.



Sinottico Taupe 100x100  
FNBS14 110 €



Sinottico 3D Satin 60x120  
FNBS11 110 €

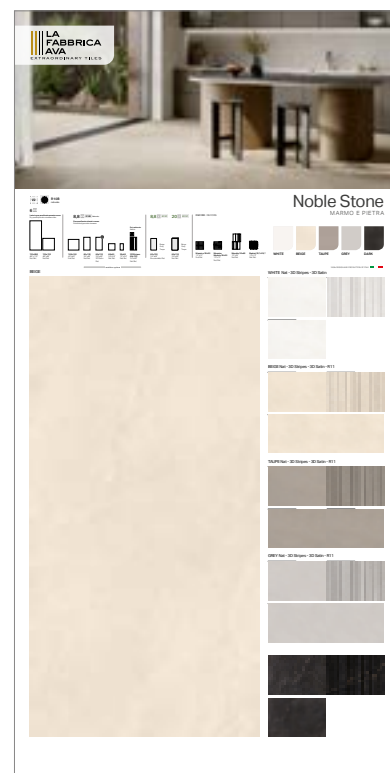

Sinottico Naturale Beige 60x120  
FNBS10 110 €

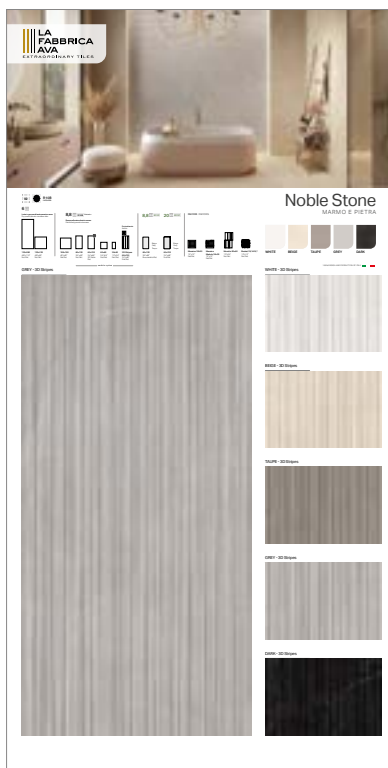

Sinottico 3D Stripes 60x120  
FNBS13 110 €



Riepilogativo Decori  
FNBS12 110 €

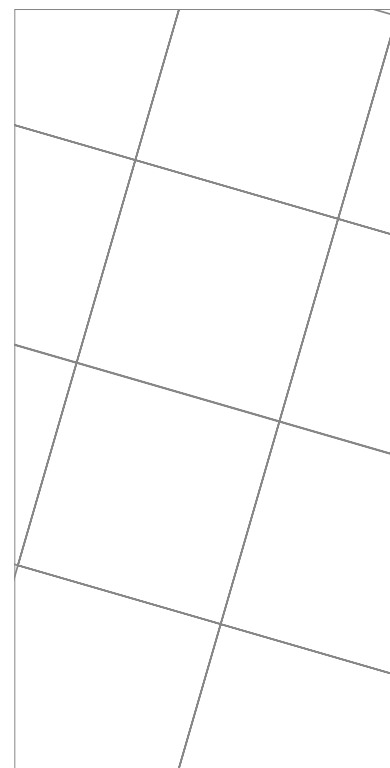

Pannello Posato  
FNBS02 85€/mq



FESL13

390€

### TOTEM LASTRE

**Totem centrosala singolo contenente 2 lastre 120x280**  
**Il prezzo si intende senza lastre**

Single center room totem contains 2 120x280 slabs  
The price is without slabs



CARTELLE AGENTI NOBLE STONE 60x60



FNBS09

30€

CARTELLA AGENTI NOBLE  
STONE 60x60

1 PZ 60x60 WHITE NAT  
1 PZ 60x60 TAUPE NAT



FNBS06

30€

CARTELLA AGENTI NOBLE  
STONE 60x60

1 PZ 60x60 BEIGE NAT  
1 PZ 60x60 BEIGE R11



FNBS07

32€

CARTELLA AGENTI NOBLE  
STONE 60x60

1 PZ 60x60 DARK NAT  
1 PZ 60x60 DARK 3D SATIN

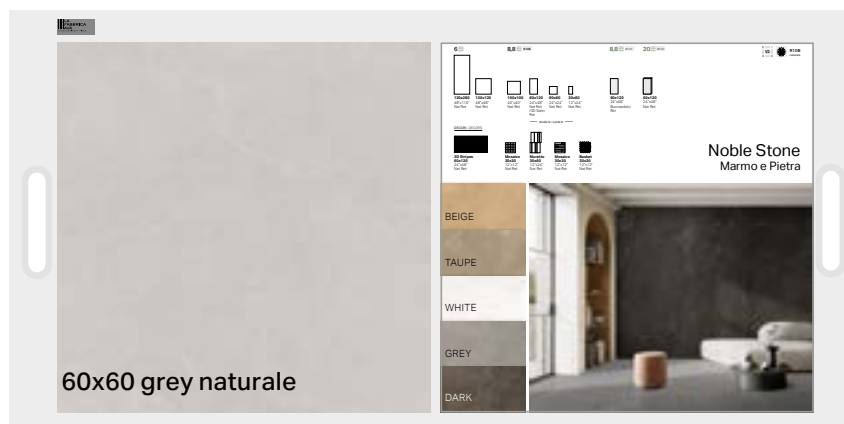

FNBS08

32€

CARTELLA AGENTI NOBLE  
STONE 60x60

1 PZ 60x60 GREY NAT  
1 ADESIVO GRAFICO 60x60 CM

PER ORDINARE IL MOBILE OUTDOOR E' NECESSARIO INSERIRE 3 CODICI COME SEGUE :

inserire nell' ordine:

1 - il codice dell' espositore vuoto, completo di banner generico outdoor



FESP14

270€  
MOBILE ESPOSITORE  
OUTDOOR + BANNER



2 - il codice del pezzo singolo Noble Stone 60x120 h20 nella colorazione desiderata



Beige 60x120 Nat. Ret.

199043



Taupe 60x120 Nat. Ret.

199045



Grey 60x120 Nat. Ret.

199042



3 - il codice del kit 3 tozzetti Noble Stone nel formato 40x40 cm



Beige



Taupe



Grey

FNBS05

26€  
KIT  
TOZZETTI  
NOBLE STONE

con etichetta da outdoor

**TO ORDER OUTDOOR FURNITURE IT IS NECESSARY TO INSERT 3 CODES AS FOLLOWS:**

insert in the order:

1 - the code of the empty exhibitor complete with generic outdoor banner



FESP14

**270€**  
**MOBILE ESPOSITORE**  
**OUTDOOR + BANNER**



2 - the code of the Noble Stone 60x120 h20 tile in the desired colors



Beige 60x120 Nat. Ret.

199043



Taupe 60x120 Nat. Ret.

199045



Grey 60x120 Nat. Ret.

199042



3 - the code of the kit of 3 Noble Stone tiles in the 40x40 cm format



Beige



Taupe



Grey

FNBS05

**26 €**  
**KIT**  
**TILES**  
**NOBLE STONE**  
with labels for outside

# ONICE IRIDE

LAFABBRICAAVAMERCHANDISING2024



**PANNELLI 100x200 SP 14 mm**

BOARDS 100x200 THK 14 mm



**FIRI109**

**€ 85** AMBRA LAP



**FIRI209**

**€ 85** AVORIO LAP



**FIRI309**

**€ 120** GIADA LAP



**FIRI409** € 85 ARGENTO LAP



**FIRI509** € 85 COBALTO LAP



**FIRI609** € 85 MALAGA LAP

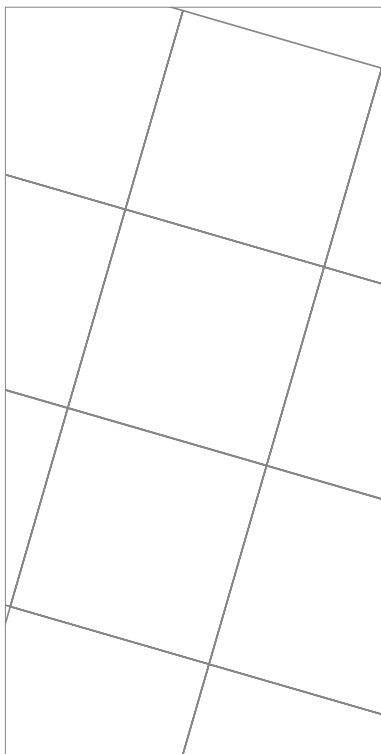

Pannello Posato  
**FIRI2** € 80/mq

# PIERRES DES CHÂTEAUX

LAFABBRICA AVAMERCHANDISING 2024



**PANNELLI 100x200 SP 14 mm**

BOARDS 100x200 THK 14 mm



**Sinottico 1**

100x100 Fontainebleau Nat. Ret.

FPC0109 - 100x200

€ 60



**Sinottico 2**

100x100 Decoro Rose Cheverny Nat. Ret.

FPC0209 - 100x200

€ 60



**Sinottico 3**

60x120 Chambord Nat. Ret.

FPC0309 - 100x200

€ 60



**Ussé**  
30x60 Nat. Ret.  
Decoro Pinot Grigio White Nat. Ret.

FPC0510 - 100x200 € 100



**Chambord**  
60x60 Nat. Ret.  
Decoro Spina di pesce Nat. Ret.

FPC0610 - 100x200 € 100



**Fontainebleau**  
60x60 Nat. Ret.  
Mosaico Nat. Ret.

FPC0810 - 100x200 € 130

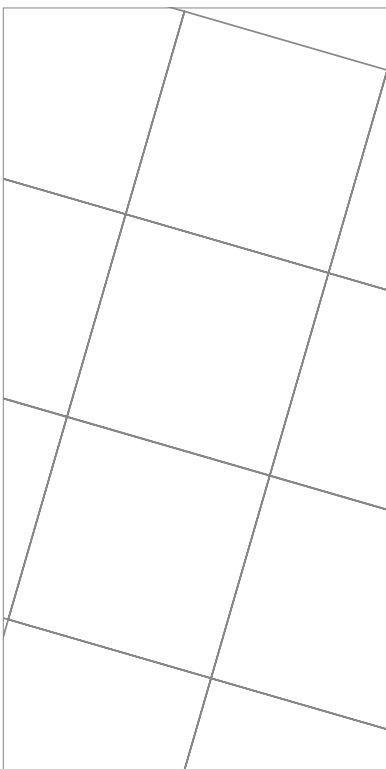

**Pannello Posato**

FPC002 € 50/mq

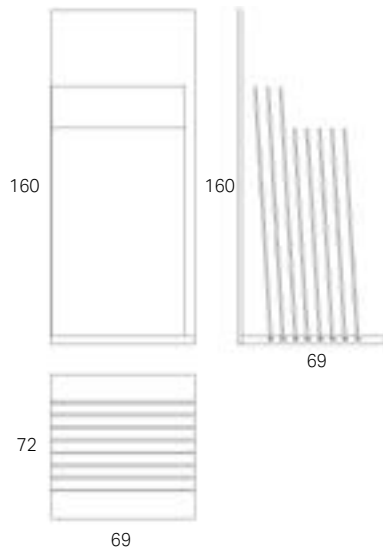

FPC0215

**150€**

**PIERRES DES CHÂTEAUX 2**

Culla contenente n. 6 pannelli + 2 pezzi 60x120  
 Cradle contains 6 panels + 2 tiles thk 60x120

**FINO AD ESAURIMENTO SCORTE**  
 AVAILABILITY LIMITED IN STOCKS

**Set composition**



**Ussè 30x60 Nat. Ret.**  
 Decoro Pinot Grigio White  
 L 64xH 100 cm



**Fontainebleau 30x60 Nat. Ret.**  
 Mosaico Nat. Ret.  
 L 64xH 100 cm



**Chambord 30x60 Nat. Ret.**  
 Spina di pesce Nat. Ret.  
 L 64xH 100 cm



**Riepilogativo 20mm**  
 L 64xH 120 cm



**Pannello schiena**  
 L 69xH 160 cm



**Chevreny 60x60 Nat. Ret.**  
 L 64xH 100 cm



**Chenonceau 30x60 Nat. Ret.**  
 L 64xH 100 cm

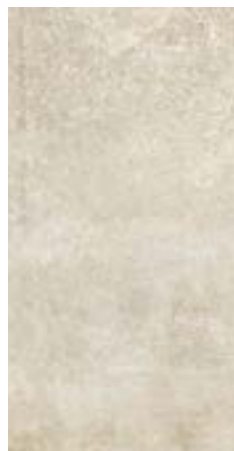

**Fontainebleau 60x120 Nat. Ret.**  
 L 60xH 120 cm



**Chambord 60x120 Nat. Ret.**  
 L 60xH 120 cm

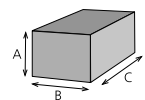

Espositore imballato (vuoto)  
 Packaged display (empty)

A 41 cm

B 163 cm

C 82 cm

Peso/Weight





# ROYAL STONE

LAFABBRICA AVAMERCHANDISING2024



## PANNELLI 100x200 SP 14 mm

BOARDS 100x200 THK 14 mm



### Sinottico

Gold 30x60 Nat. Ret. - Gold 60x60 Nat. Ret.  
FROY109 - 100x200

€ 55

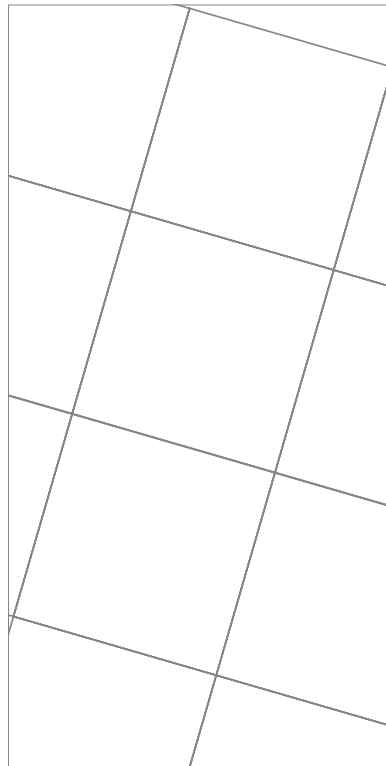

### Pannello Posato

FROY02

€ 50/mq



## PANNELLI 100x200 SP 14 mm

BOARDS 100x200 THK 14 mm



Sinottico

Lap 6,6 mm.

FSHR01- 100x200

120€

# SCRATCH

PANNELLI 100x200 SP 14 mm

BOARDS 100x200 THK 14 mm



**FSCR109** € 70 SCR MOONLIGHT NAT



**FSCR209** € 70 SCR SUPERLUNA NAT



**FSCR309** € 70 SCRATCH ECLIPSE NAT



**FSCR409** € 70 STCRATCH MILK WAY NAT



**FSCR509** € 70 SCR LIGHT GRAFFITI NAT



**FSCR609** € 70 SCR DARK GRAFFITI NAT

PANNELLI 100x200 SP 14 mm  
BOARDS 100x200 THK 14 mm



**FSKY109** € 70 SKYLINE ANTRACITE NAT



**FSKY409** € 70 SKYLINE BEIGE NAT



**FSKY209** € 70 SKYLINE FUMO NAT



**FSKY309** € 70 SKYLINE GHIACCIO NAT

# SMALL

LAFABBRICA AVAMERCHANDISING 2024



TOZZETTARI  
CATALOGUES

Nuovo layout folder SMALL dal 2024  
è studiato per svolgere la funzione di folder per clienti, folder per  
library  
non solo folder agenti

FSML39

16€

**FOLDER SMALL**

INTERNO

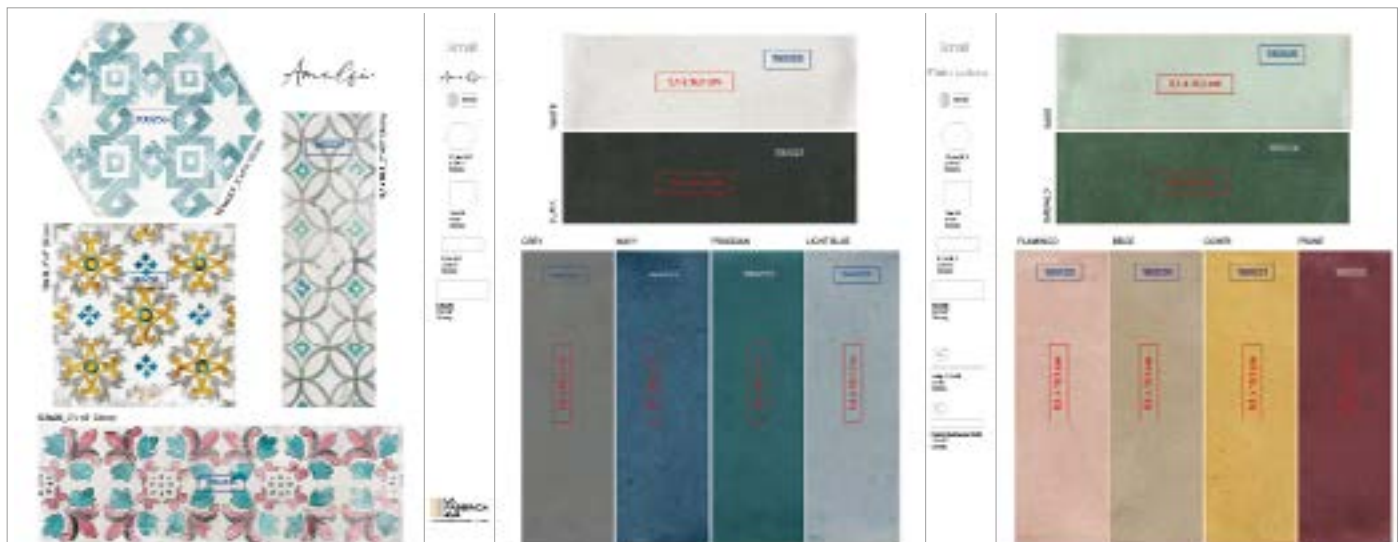

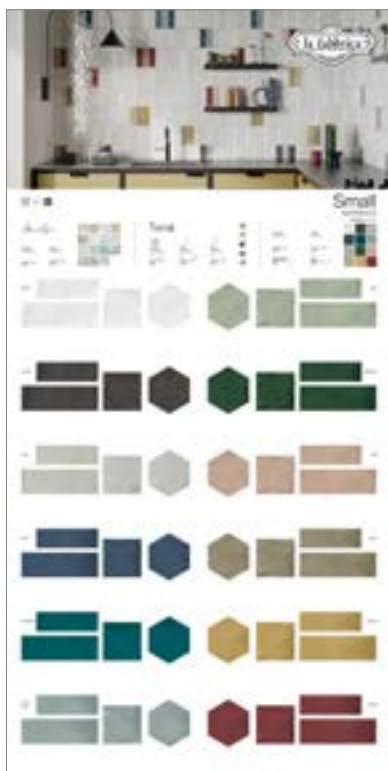

Sinottico 1  
Small - 12 colours  
FSML10 € 85,00



Sinottico 2  
Small - Trend  
FSML11 € 88,00



Sinottico 3  
Small - Amalfi  
FSML12 € 95,00



Small 1  
12,4x10,7 cm - White, Sage, Emerald, Ocher  
Flamingo, Grey, Prune, Navy, Light Blue  
FSML13 € 130,00

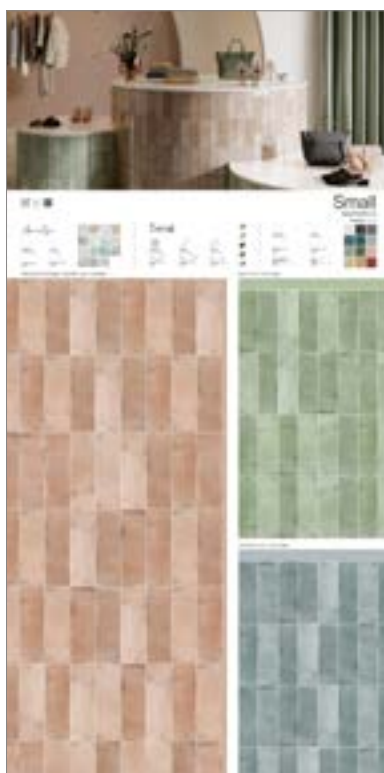

Small 2  
6,5x20 cm - Flamingo, Sage, Light Blue  
FSML14 € 90,00



Small 3  
5,1x16,1 cm - Black, Sage, Flamingo  
White, Light Blue, Navy  
FSML15 € 130,00

**PANNELLI 100x200 SP 14 mm**  
BOARDS 100x200 THK 14 mm



**Small 4**  
5,1x16,1 cm - Grey, Ocher, Prune, Beige, Emerald  
FSML16 € 150,00

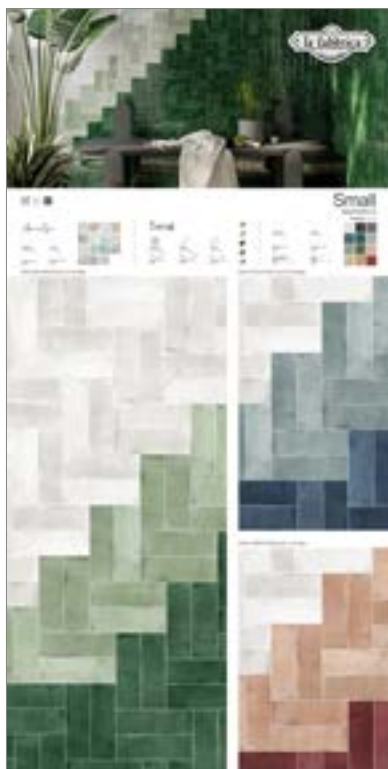

**Small 5**  
6,5x20 cm - White, Sage, Emerald, Light Blue, Navy, Flamingo, Prune  
FSML17 € 120,00



**Small 6**  
5,1x16,1 cm - White, Black, Grey, Sage, Emerald, Flamingo, Prune  
FSML18 € 120,00



**Small Trend 1**  
10x10 cm - Prune, White, Trend Ocher  
6,5x20 - Sage, Light Blue, White  
10x10 cm - Trend Beige, Trend, Light Blue  
FSML22 € 85,00



**Small Trend 2**  
10x10 cm - Prune, Black, Beige, Trend Arco  
Light Blue, Trend Arco Black, Trend Arco Beige  
FSML23 € 95,00



**Small Trend 3**  
10x10 cm - Sage, White, Light Blue, Trend Arco  
Navy, Trend Arco Beige, Trend Arco Light Blue  
FSML24 € 95,00





**Small Trend 4**

10x10 cm - Sage, White, Flamingo, Grey,  
Trend Arco Beige, Trend Arco Light Blue,  
Trend Arco Black

**FSML25**

**€ 98,00**



**Small Trend 5**

6,5x20 cm - Black, Beige, Prussian, White,  
Prune, Navy, Sage, Trend Sun Black,  
Trend Sun Ocher, Trend Sun Navy

**FSML26**

**€ 100,00**



**Small Trend 6**

5,1x16,1 cm - Sage, White, Navy, Black,  
Trend Beige, Trend Navy, Trend Black

**FSML27**

**€ 100,00**

**PANNELLI 100x200 SP 14 mm**

BOARDS 100x200 THK 14 mm

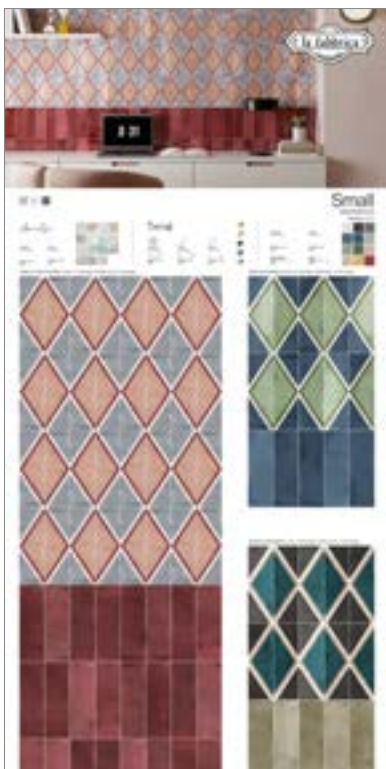

**Small Trend 7**

6,5x20 cm - Prune, Navy, Beige,  
Trend Rhombus Light Blue, Trend Rhombus  
Navy, Trend Rhombus Black

**FSML28 € 88,00**



**Small Trend 8**

10x10 cm - Ocher, Black, Prussian, Navy,  
Sage, Trend Arco Ocher, Trend Arco Beige,  
Trend Arco Navy

**FSML29 € 82,00**



**Small Trend 9**

12,4x10,7 cm - Navy, White, Beige, Flamingo,  
Trand Navy, Trend Beige, Trend Light Blue

**FSML30 € 130,00**



**Small Trend 10**

12,4x10,7 cm - Trend Light Blue, Trend Ocher, Trend  
Black - 6,5x20 cm - Prune, Light Blue, Ocher, Beige,  
Prussian

**FSML31 € 130,00**



**Small Amalfi 1**

5,1x16,1 cm - White, Amalfi, Prussian

**FSML19 € 120,00**



**Small Amalfi 2**

12,4x10,7 cm - White, Amalfi  
10x100 cm - Ocher

**FSML20 € 120,00**

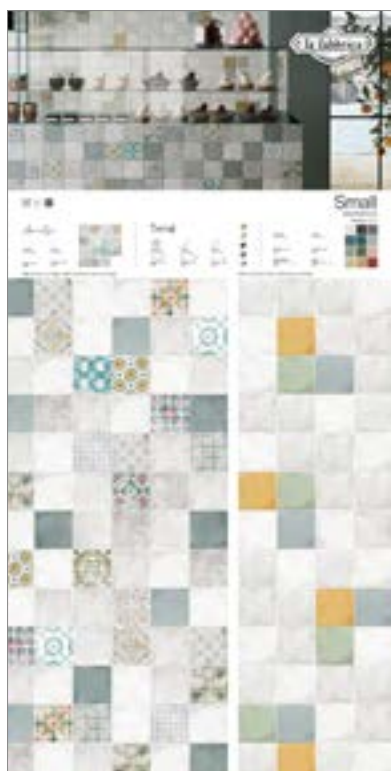

**Small Amalfi 3**  
 10x10 cm - Amalfi, White, Light Blue,  
 Ocher, Sage  
**FSML21** € 85,00

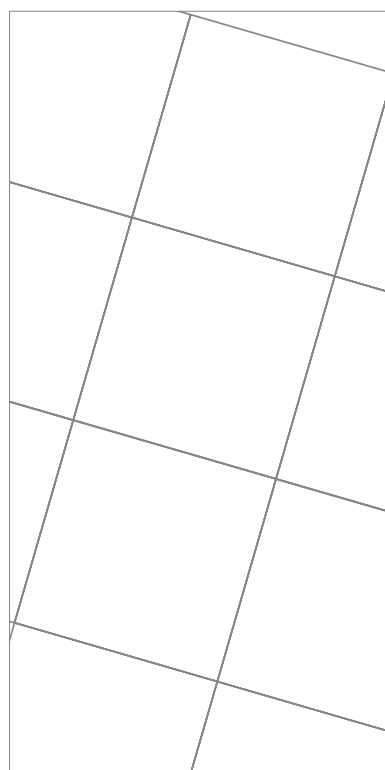

**Pannello Posato**  
**FSML02** € 80,00

**ESPOSITORE SMALL**  
 DISPLAY FOR SINGLE TILES SMALL

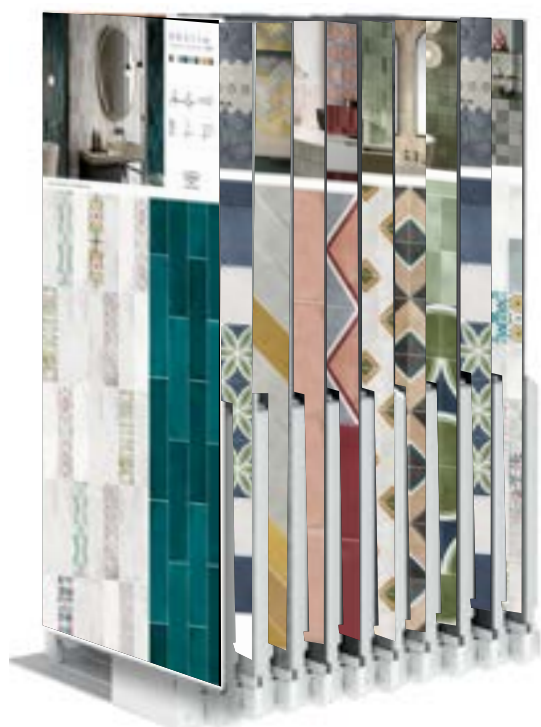

FSML01

**700€**

**SET SMALL CON PANNELLI 60x120**

Espositore scorrevole monofacciale per 10 pannelli 60x120  
 Exhibitor accomodating whit 10 single-side sliding boards  
 60x120

**FINO AD ESAURIMENTO SCORTE**  
 AVAILABILITY LIMITED IN STOCKS

FSML08

**62€**

**SET DA BANCO SMALL TREND**

1 pannello posato 16,6x24 cm

4 pannelli posati 20,3x24 cm

1 pannello posato 23,5x25,5 cm

**FINO AD ESAURIMENTO SCORTE**

*AVAILABILITY LIMITED IN STOCKS*





**PANNELLI 100x200 SP 14 mm**  
BOARDS 100x200 THK 14 mm

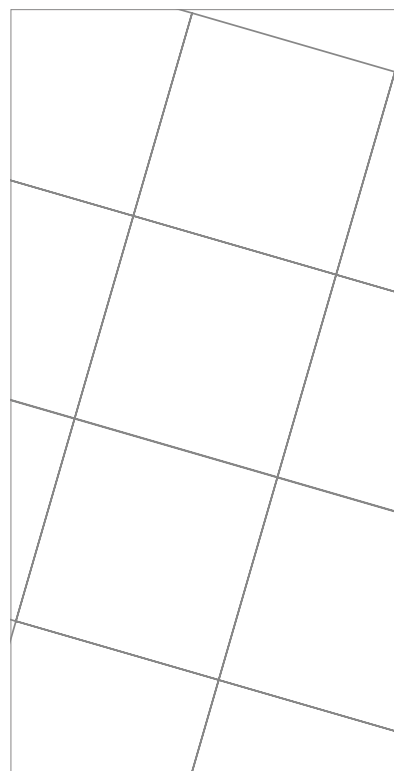

Pannello Posato

FSPA02

€ 50/mq

**SCATOLA**

BOX



SCA106

**50€**

**SCATOLA SPACE**

Box contenente n. 20 20x20 cm.  
Box contains 20 pieces 20x20 cm.

**FINO AD ESAURIMENTO SCORTE**

AVAILABILITY LIMITED IN STOCKS

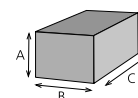

Espositore  
Display

A 20 cm

B 40 cm

C 29 cm

Kg 15

# STATUARIO

LAFABBRICA AVAMERCHANDISING 2024



## PANNELLI 100x200 SP 14 mm

BOARDS 100x200 THK 14 mm



**FSTT01** € 100 STATUARIO NAT



**FSTT02** € 110 STATUARIO LAP



**PANNELLI 100x200 SP 14 mm**  
BOARDS 100x200 THK 14 mm



**FSTR109** € 70 STATUARIO REALE NAT



**FSTR209** € 80 STATUARIO REALE LAP

# STORM

LAFABBRICA AVAMERCHANDISING 2024



## PANNELLI 100x200 SP 14 mm

BOARDS 100x200 THK 14 mm

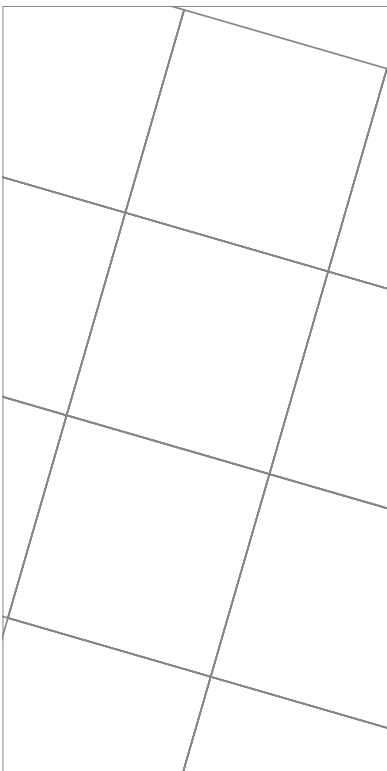

Pannello Posato

FSTO02

€ 50/mq



# TRAVERTINO CLASSIC

LAFABBRICAAVAMERCHANDISING2024



**PANNELLI 100x200 SP 14 mm**  
BOARDS 100x200 THK 14 mm



**FTRC01 € 100 TRAVERT CLASSIC NAT**



**FTRC02 € 110 TRAVERT CLASSIC LAP**

UP

LAFABBRICAAVAMERCHANDISING2024



FUP001

240€

KIT 2 SET DA BANCO UP

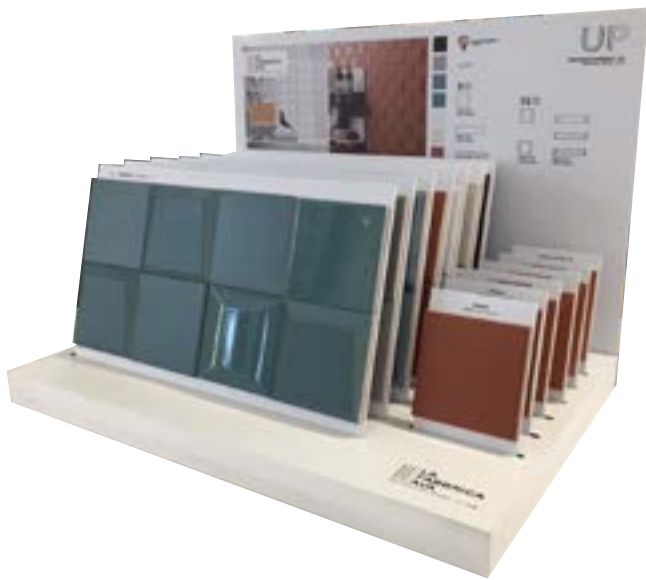

**SET DA BANCO UP  
10x10**

this pannel just exemple  
10x10 sold by box  
not by composition

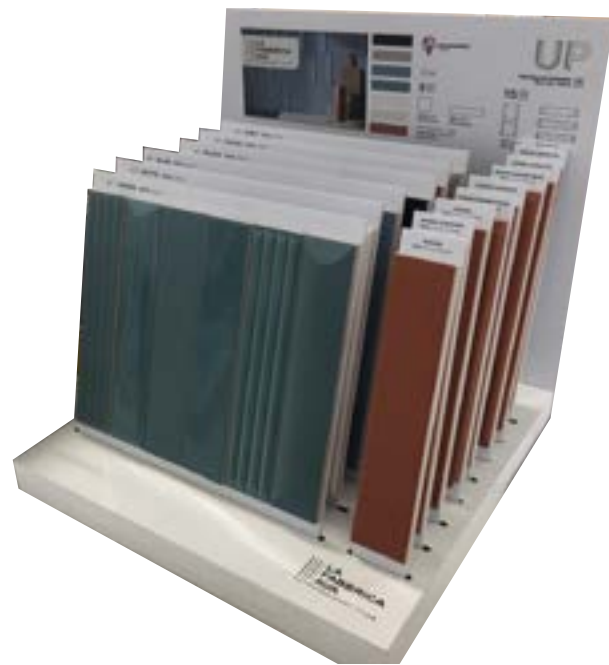

**SET DA BANCO UP  
5x25**

this pannel just exemple  
10x10 sold by box  
not by composition

FUP004

110 €

**KIT 2 FOLDER UP**

31x48 cm

FINO ESAURIMENTO SCORTE  
*AVAILABILITY LIMITED IN STOCKS*

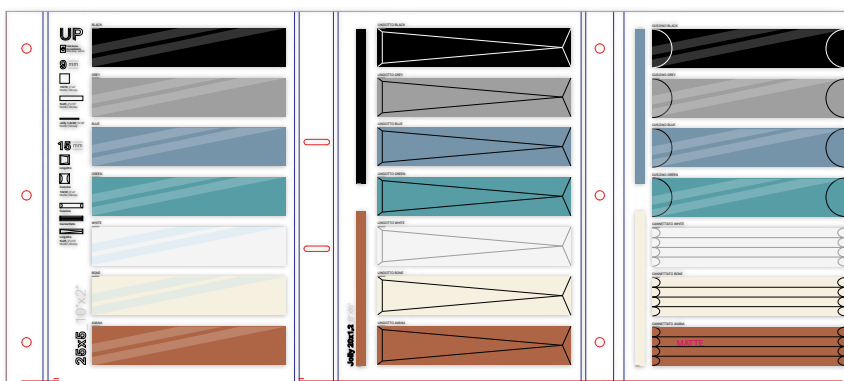
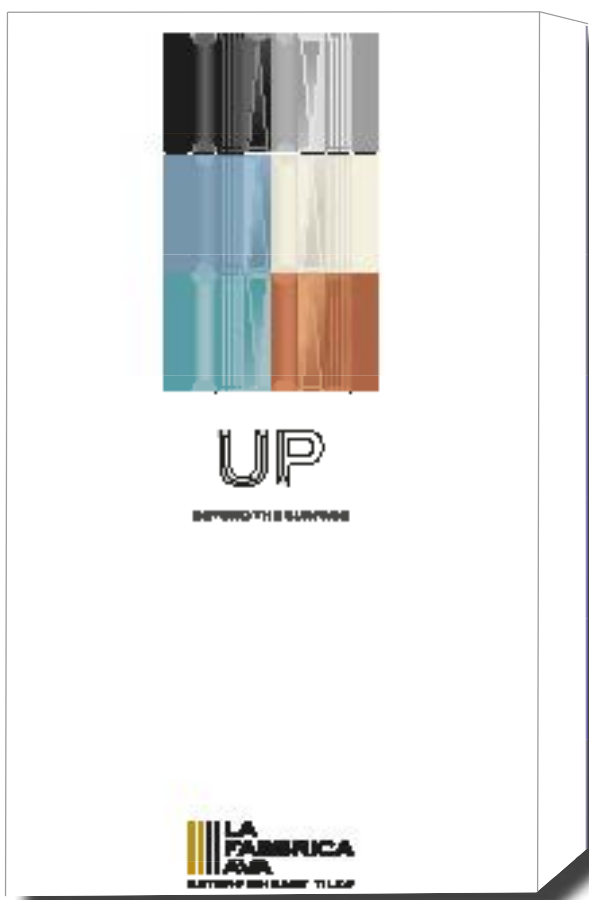

Nuovo layout folder UP dal 2024  
è studiato per svolgere la funzione di folder per clienti,  
folder per library  
non solo folder agenti

FUP019

16€  
**FOLDER UP**  
31x48 cm

ESTERNO

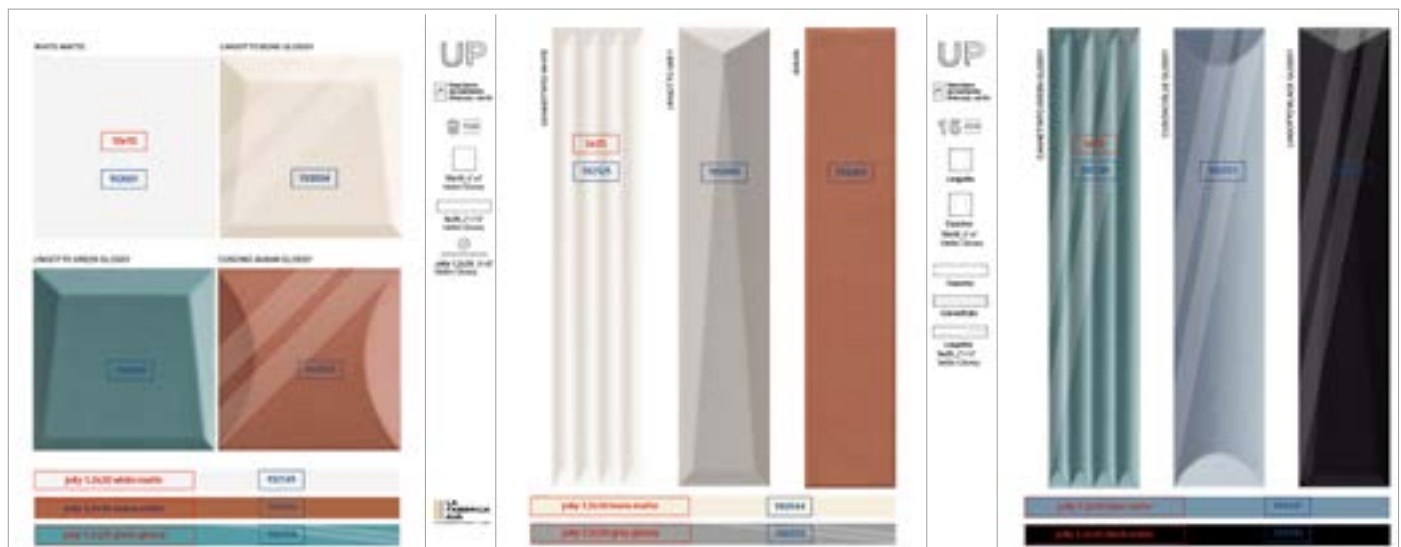

INTERNO



FUP005

600€

**ESPOSITORE A TIRO 60x120**

Espositore scorrevole monofacciale per 10 pannelli 60x120  
Exhibitor accommodating 10 single-side sliding boards 60x120

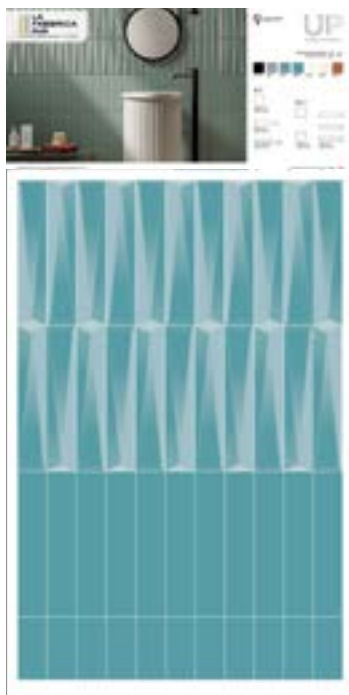

**Green**  
5x25 matte + 5x25 linogotto glossy



**Blue + Bone**  
White 5x25 matte  
Blue 5x25 linogotto glossy



**White**  
5x25 matte + 5x25 glossy  
5x25 cuscino matte

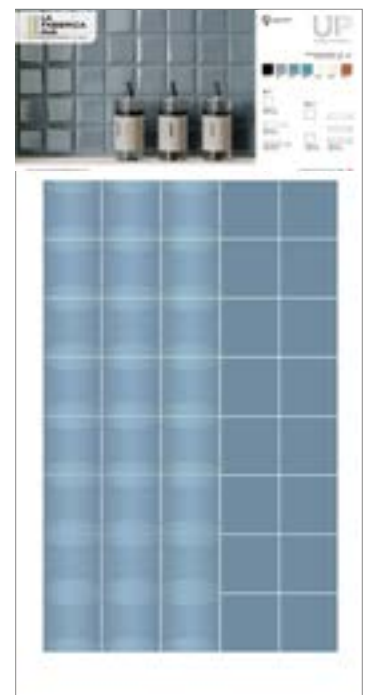

**Blue**  
10x10 matte  
10x10 cuscino matte

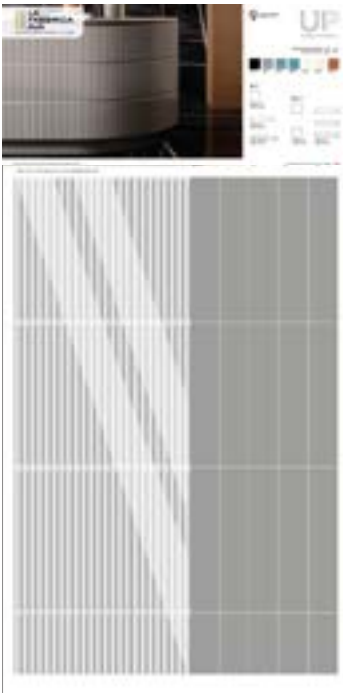

**Grey**  
 5x25 matte  
 5x25 Canettato glossy

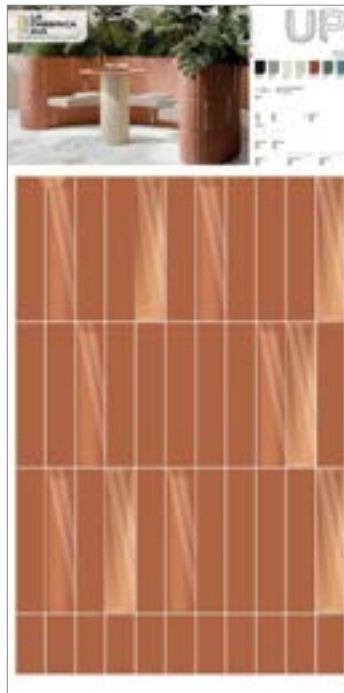

**Avana**  
 5x25 matte  
 5x25 glossy

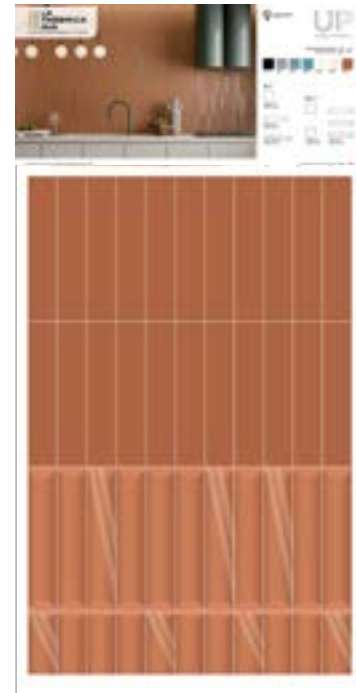

**Avana**  
 5x25 matte  
 5x25 Cuscino glossy



**Green**  
 10x10 matte  
 10x10 glossy  
 10x10 Lingotto glossy



**Black**  
 10x10 matte  
 10x10 Lingotto glossy

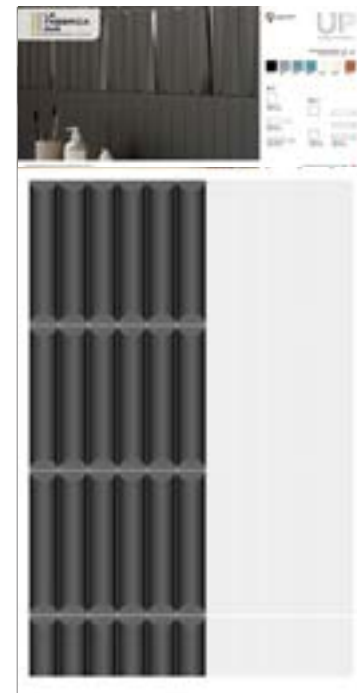

**Black + White**  
 White 5x25 matte  
 Black 5x25 Canettato matte

**PANNELLI 100x200 SP 14 mm**  
BOARDS 100x200 THK 14 mm



Sinottico 1  
FUP006 - 100x200 70 €



Sinottico 2  
FUP007 - 100x200 65 €



Sinottico 3  
FUP008 - 100x200 75 €

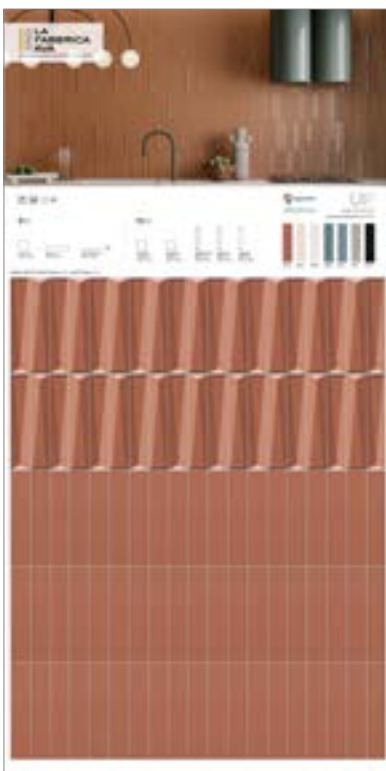

Avana  
FUP009 - 100x200 95 €



Bone  
FUP012 - 100x200 95 €



White  
FUP015 - 100x200 120 €



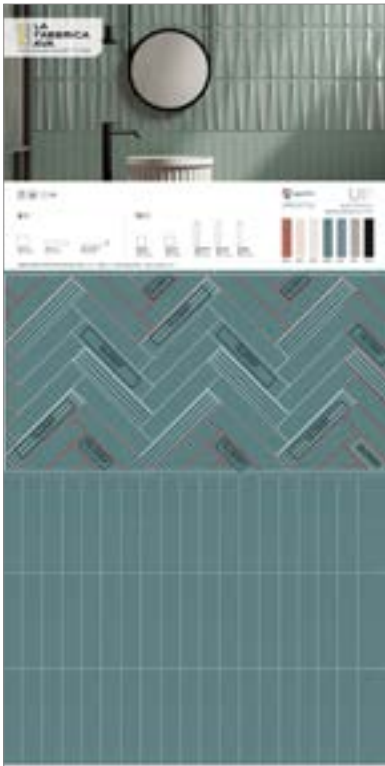

Green  
FUP013 - 100x200      125 €

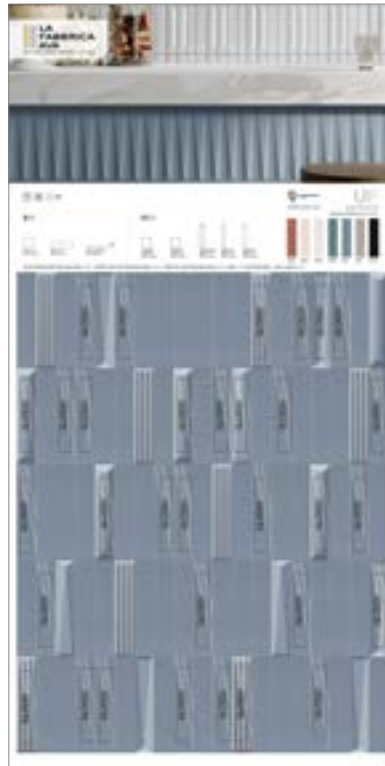

Blue  
FUP011 - 100x200      95 €



White  
FUP016 - 100x200      85 €

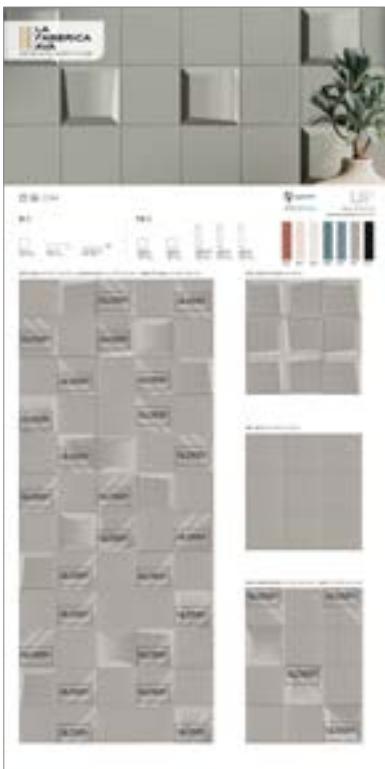

Grey  
FUP014 - 100x200      85 €

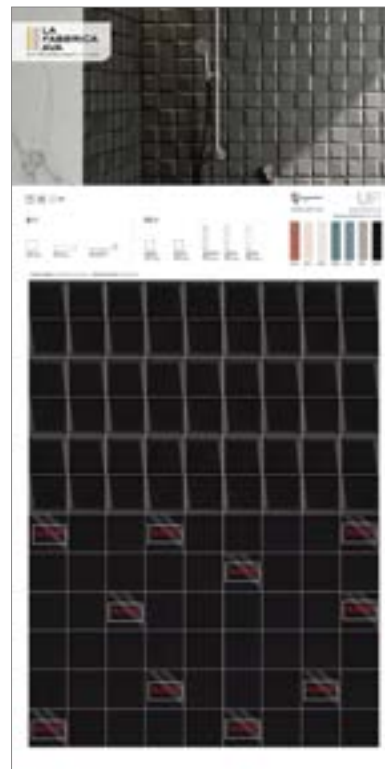

Black  
FUP010 - 100x200      90 €

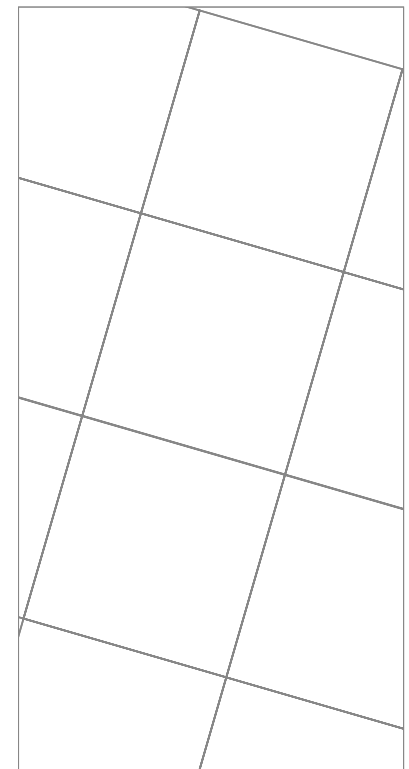

Pannello Posato  
FUP002      €/mq



*Lanino Lamborghini*





*Tonino Lamborghini*



FKOR03

290€  
**MOBILE 1 COLONNA  
TONINO LAMBORGHINI  
FRAME 30x30**

1 COLUMN UNIT  
TONINO LAMBORGHINI  
FRAME 30x30

FKOR04

300€  
**KIT PIASTRELLE - 25 PZ CM 29,7x29,7**

Espositore imballato (vuoto)  
*Packaged display (empty)*

A 80 cm

B 80 cm

C 160 cm

Peso/Weight

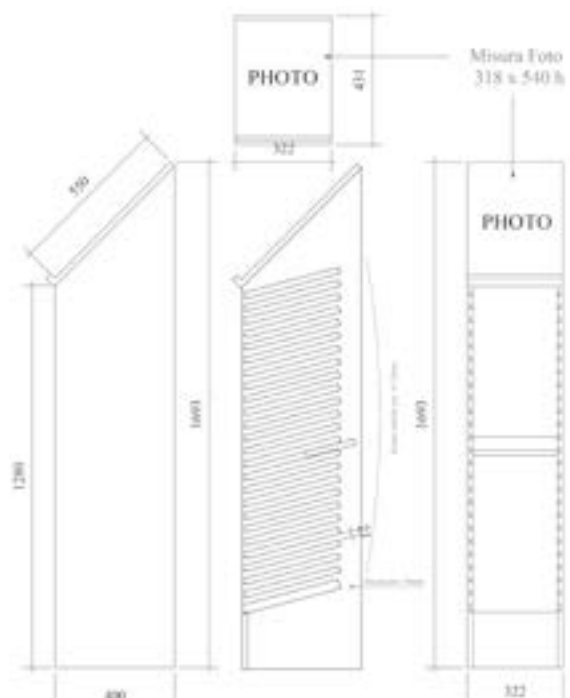
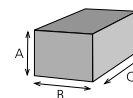

F99040

16€  
**AGGIORNAMENTO BANNER  
TOTEM KORIUUM**





FESL13

390€

### TOTEM LASTRE

**Totem centrosala singolo contenente 2 lastre 120x280**  
**Il prezzo si intende senza lastre**

Single center room totem contains 2 120x280 slabs  
The price is without slabs



FMGL03

75€

**FOLDER MAGMA** 31x48 cm

4 tozzetti formato cm 10x29,7 6 mm - 4 tile cuts, size cm 10x29,7 6mm  
1 tozzetto formato cm 29,7x29,7 6 mm - 1 tile cuts, size cm 29,7x29,7 6mm

**TOZZETTI**

- 10x29,7
- BLACK & WHITE
- GREEN
- NATURAL
- AVIO
- MONOGRAMMA
- 29,7x29,7
- MAGMA LOGO

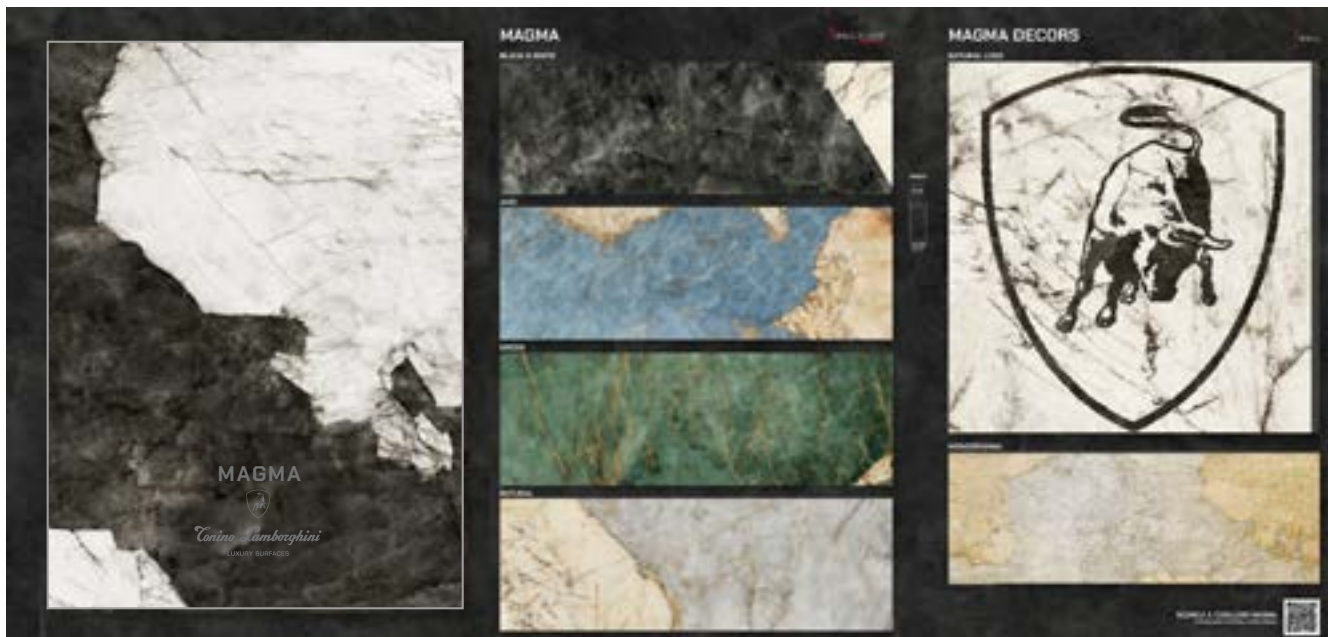
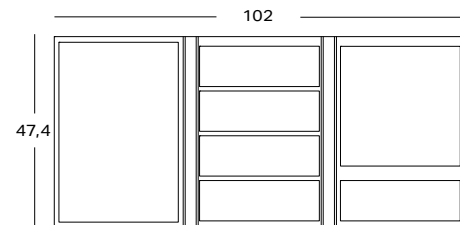



FMGL04

90€

### SCATOLA MAGMA

Scatola contenente tozzetti sp 6 mm

6 pz 29,7x29,7

Box contains tile cuts thk 6 mm

6 pieces 29,7x29,7

### TOZZETTI

29,7x29,7

BLACK & WHITE

GREEN

NATURAL

AVIO

MONOGRAMMA

MAGMA LOGO

Black e White



Natural



Monogramma



Green



Avio



Magma Logo





FESL13

**390€**

### TOTEM LASTRE

**Totem centrosala singolo contenente 2 lastre 120x280**  
**Il prezzo si intende senza lastre**

Single center room totem contains 2 120x280 slabs  
The price is without slabs







**LA  
FABBRICA  
AVA**

EXTRAORDINARY TILES

# PARTE TECNICA

Technical Section  
Partie Technique  
Technischer Teil

1

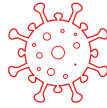

## ELIMINA I VIRUS

ELIMINATES VIRUSES.  
ÉLIMINE LES VIRUS.  
ELIMINIERT VIREN.

ISO 18061:2014 (E)  
Coronavirus 229E

TEST TCNA  
(TILE COUNCIL OF NORTH AMERICA)



**Tempo di esposizione**  
Exposure time  
Temps d'exposition  
Expositionsdauer

15 min

30 min

1 h

6 h

8 h



**Riduzione con esposizione UV**  
Reduction under UV exposure  
Réduction avec exposition aux rayons UV  
Reduzierung mit UV-Exposition

90%

90%

90%

100%

100%



**Riduzione senza esposizione UV**  
Reduction under Dark conditions  
Réduction sans exposition aux rayons UV  
Reduzierung ohne UV-Exposition

-

90%

90%

93%

99%

3

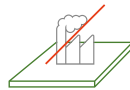

## RIDUCE L'INQUINAMENTO ATMOSFERICO

REDUCTION OF ATMOSPHERIC POLLUTION.  
RÉDUCTION DE LA POLLUTION ATMOSPHÉRIQUE.  
REDUZIERTE UMWELTVERSCHMUTZUNG

UNI 11484

ATTESTED BY THE UNIVERSITY OF TURIN  
DEPARTEMENT OF CHEMISTRY

**20,7% di NOx**

CONVERTS VOLATILE POLLUTANTS INTO HARMLESS SUBSTANCES.

The anti-pollution properties of **ADVANCE®** stoneware also improve the quality of the air we breathe. Industrial production, the use of air conditioning systems and vehicles emit pollutants into the atmosphere. **ADVANCE®** used outdoors on the façades of buildings and apartment blocks, **reduces NOx (nitrogen oxide) molecules by 20.7%** (as attested by the University of Turin) in just three hours, considerably improving air quality thanks to the photocatalytic action activated by natural light. Each outdoor solution designed using **ADVANCE®** contributes towards **improving the environment around us.**

The technology is not only safe for our health, but it is also a sustainable choice that takes care of the environment thanks to the single firing at a very high temperature, and because no further treatments are required and it has no further impact on the environment.

CONVERTE LE SOSTANZE INQUINANTI VOLATILI IN SOSTANZE INNOCUE.

Le proprietà antinquinanti del gres **ADVANCE®** migliorano anche la qualità dell'aria che respiriamo. La produzione industriale, l'utilizzo di impianti di climatizzazione e dei mezzi di trasporto, emettono nell'aria sostanze inquinanti.

**ADVANCE®** applicata in esterno, nelle pavimentazioni Outdoor, sulle facciate di abitazioni e palazzi, **riesce a diminuire le molecole di NOx (Ossidi di Azoto) del 20,7%** (come attestato dall'Università di Torino) in sole tre ore, permettendo di migliorare notevolmente la qualità dell'aria grazie all'azione fotocatalitica che si attiva alla luce naturale.

Ogni soluzione outdoor progettata con **ADVANCE®** **contribuisce a migliorare l'ambiente che ci circonda.** Una tecnologia sicura per la nostra salute e una scelta sostenibile e attenta all'ambiente, in quanto realizzata in un'unica cottura ad altissima temperatura, senza perciò la necessità di ulteriori trattamenti e relativi impatti sull'ambiente.

TRANSFORME LES POLLUANTS VOLATILS EN SUBSTANCES INOFFENSIVES.

Les propriétés antipollution du grès **ADVANCE®** améliorent également la qualité de l'air que nous respirons. La production industrielle, l'usage de systèmes de climatisation et l'utilisation des moyens de transport émettent des polluants atmosphériques. La technologie **ADVANCE®**, appliquée sur les façades extérieures des habitations et des bâtiments, permet de **réduire la concentration de molécules de NOx (oxydes d'azote) de 20,7%** (comme l'a confirmé l'Université de Turin) en seulement trois heures, ce qui permet d'améliorer de façon considérable la qualité de l'air grâce à l'action photocatalytique qui s'active à la lumière naturelle.

Les espaces extérieurs conçus avec **ADVANCE®** permettent **d'améliorer l'environnement qui nous entoure.** En plus d'être sûre pour notre santé, la technologie représente également un choix durable et respectueux de l'environnement étant donné qu'elle est réalisée lors d'une cuisson unique à très haute température et qu'elle ne nécessite pas de traitements ultérieurs : elle n'engendre donc pas d'impacts supplémentaires sur l'environnement.

FLÜCHTIGE SCHADSTOFFE WERDEN IN UNBEDENKLICHE STOFFE UMGEWANDELT.

Die schadstoffmindernden Eigenschaften des Feinsteinzeugs **ADVANCE®** verbessern auch die Qualität unserer Atemluft. Die industrielle Produktion, der Einsatz von Klimaanlage und die Transportmittel tragen zum Ausstoß von Schadstoffen in die Luft bei.

Durch die Verwendung von **ADVANCE®** in Außenbereichen, an den Fassaden von Wohnungen und Gebäuden, **können die NOx-Moleküle (Stickstoffoxid) in nur drei Stunden um 20,7% reduziert werden** (laut Bescheinigung der Universität Turin). Durch die von natürlichem Licht aktivierte photocatalytische Wirkung kann die Qualität der Luft so beachtlich verbessert werden. Alle mit **ADVANCE®** realisierten Outdoor-Lösungen **tragen zu einer Verbesserung unserer Umwelt bei.** Diese Technologie ist nicht nur sicher für unsere Gesundheit, sondern auch eine nachhaltige und umweltfreundliche Entscheidung, da sie einen einzigen Brennvorgang bei extrem hohen Temperaturen vorsieht, ohne Notwendigkeit nachfolgender Behandlungen und damit ohne weitere Umweltauswirkungen.

2

## COMBATTE I BATTERI

FIGHTS BACTERIA.  
COMBAT LES BACTÉRIES.  
BEKÄMPFT BAKTERIEN.

ISO 27447:2019 (E)  
Escherichiacoli ATCC 8739  
Stafilococco Aureo ATCC 6538

TEST DEL LABORATORIO CFR-UNIFE AND TCNA



### Tempo di esposizione

Exposure time  
Temps d'exposition  
Expositionsdauer

8 h



### Riduzione con esposizione UV

Reduction under UV exposure  
Réduction avec exposition aux rayons UV  
Reduzierung mit UV-Exposition

MIN. 95% - MAX 100%



### Riduzione senza esposizione UV

Reduction under Dark conditions  
Réduction sans exposition aux rayons UV  
Reduzierung ohne UV-Exposition

MIN. 93,4% - MAX 97,2%

4

## COMBATTE LO SPORCO

COMBATS DIRT.  
COMBAT LA SALETÉ.  
BEKÄMPFT SCHMUTZ.

### RIDUCE LA NECESSITÀ DI DETERGENTI CHIMICI.

Lo sporco si disgrega sulle superfici ceramiche ADVANCE® e ciò permette di mantenere puliti i pavimenti e i rivestimenti tramite il solo utilizzo di acqua e sapone neutro.

Per i pavimenti esterni lo scorrere dell'acqua piovana è sufficiente per garantirne la pulizia.

### REDUCES THE NEED TO USE CHEMICAL DETERGENTS.

Dirt disintegrates on the surface of ADVANCE® tiles, floors and walls can be kept clean by just washing with a neutral soap and water. For outdoor floors, the flow of rainwater is enough to guarantee cleanliness.

### RÉDUIT LE RECOURS AUX DÉTERGENTS CHIMIQUES.

La saleté se décompose sur les surfaces en céramique ADVANCE®, ce qui permet de conserver un sol et des murs propres en les lavant uniquement à l'eau et au savon doux. Pour les sols extérieurs, l'écoulement de l'eau de pluie suffit à garantir une propreté optimale.

### REDUZIERT DEN EINSATZ CHEMISCHER REINIGUNGSMITTEL.

Der Schmutz zersetzt sich auf den Keramikoberflächen von ADVANCE®. So können Bodenbeläge und Wandverkleidungen einfach mit Wasser und einem neutralen Reinigungsmittel sauber gehalten werden. Bei Bodenbelägen im Außenbereich garantiert bereits das Abfließen von Regenwasser eine ausreichende Reinigung.

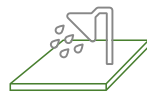

5

## COMBATTE I CATTIVI ODORI

MITIGATES BAD ODOURS.  
RÉDUIT LES MAUVAISES ODEURS.  
HEMPT ÜBLE GERÜCHE.

### TRASFORMA LE MOLECOLE ORGANICHE RIDUCENDO I CATTIVI ODORI.

Come per gli NOx, le molecole fonti di cattivi odori si decompongono non appena entrano in contatto con la superficie, attenuandone così l'effetto odorifero.

### REDUCES BAD ODOURS BY CONVERTING THE ORGANIC MOLECULES.

Furthermore, as for NOx molecules, the molecules that cause bad odours decompose as soon as they come into contact with the surface, thus mitigating any malodorous effect.

### TRANSFORME LES COMPOSÉS ORGANIQUES ET RÉDUIT LES MAUVAISES ODEURS.

Comme pour les NOx, les composés à l'origine des mauvaises odeurs se décomposent dès qu'ils entrent en contact avec la surface, réduisant ainsi les mauvaises odeurs.

### VERWANDELT ORGANISCHE MOLEKÜLE UND REDUZIERT SO ÜBLE GERÜCHE.

Ebenso wie die NOx-Moleküle zersetzen sich auch die für üble Gerüche verantwortlichen Moleküle, sobald sie mit der Oberfläche in Kontakt kommen und hemmen somit die Geruchsbildung.

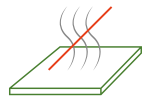

# SCHEMI DI POSA

Laying sketch

Schémas de pose

Modulverlegungsbeispiele

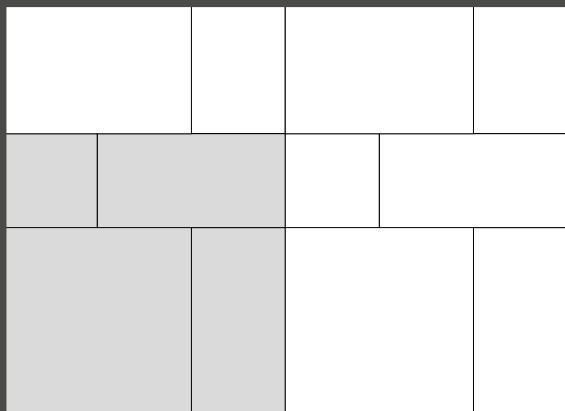

$120 \times 120 = 57,1\%$   
 $60 \times 120 = 28,6\%$   
 $60 \times 60 = 14,3\%$

**A**

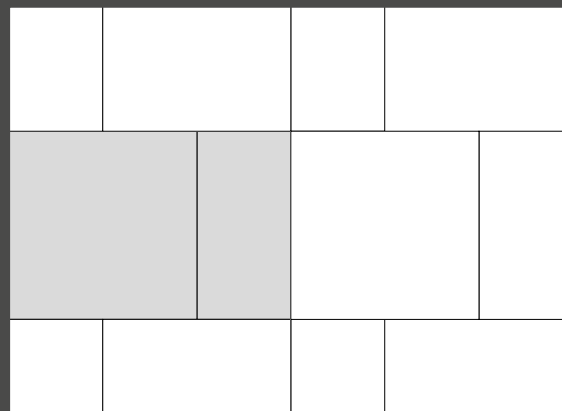

$120 \times 120 = 66,7\%$   
 $60 \times 120 = 33,3\%$   
 $100 \times 100 = 66,7\%$   
 $50 \times 100 = 33,3\%$

**B**

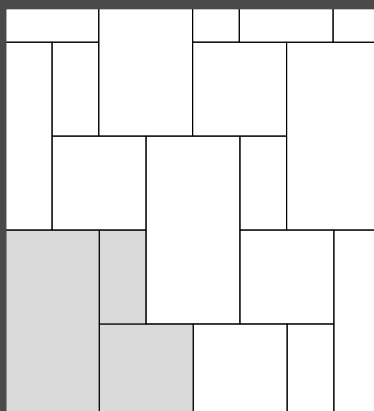

$60 \times 120 = 57,1\%$   
 $60 \times 60 = 28,6\%$   
 $30 \times 60 = 14,3\%$

**C**

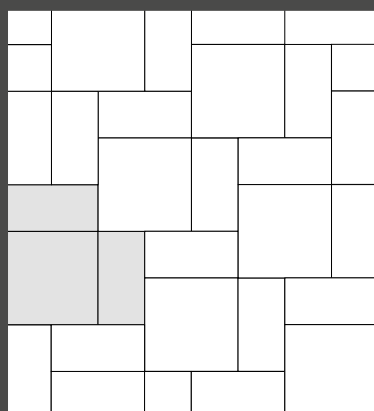

$60 \times 60 = 50\%$   
 $30 \times 60 = 50\%$

**D**

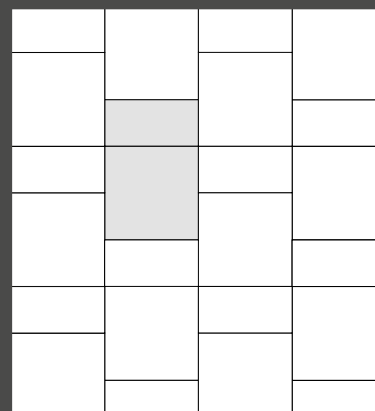

$60 \times 60 = 66,7\%$   
 $30 \times 60 = 33,3\%$

**E**

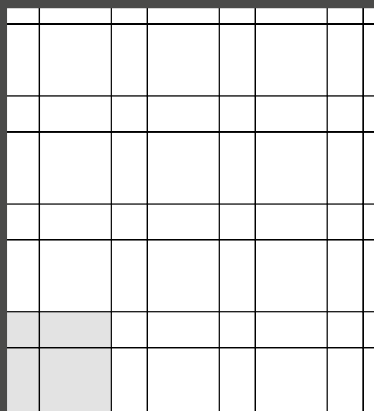

$40,6 \times 40,6 = 44,4\%$   
 $20,3 \times 40,6 = 44,4\%$   
 $20,3 \times 20,3 = 11,1\%$

**F**

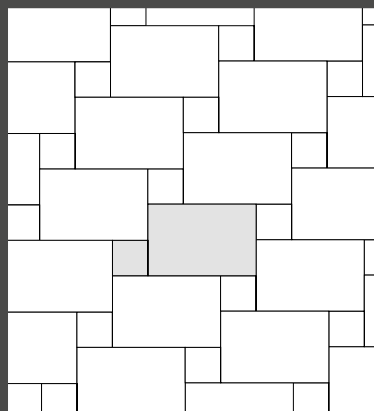

$40,6 \times 60,9 = 85,7\%$   
 $20,3 \times 20,3 = 14,3\%$

**G**

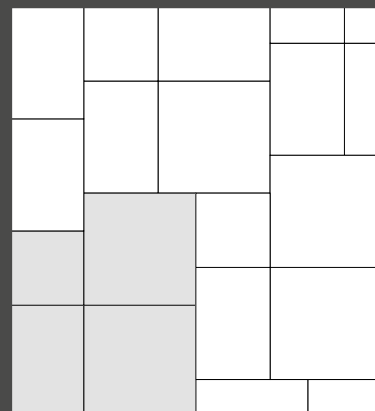

$60,9 \times 60,9 = 64,3\%$   
 $40,6 \times 60,9 = 21,4\%$   
 $40,6 \times 40,6 = 14,3\%$

**H**

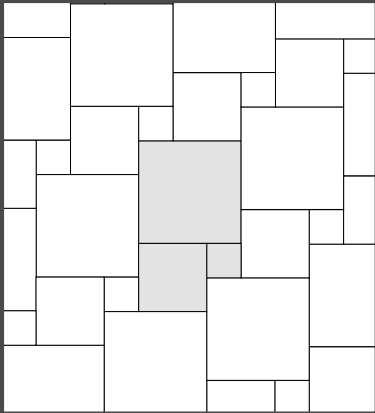

60,9x60,9=64,4%  
40,6x40,6=28,6%  
20,3x20,3=7%

I

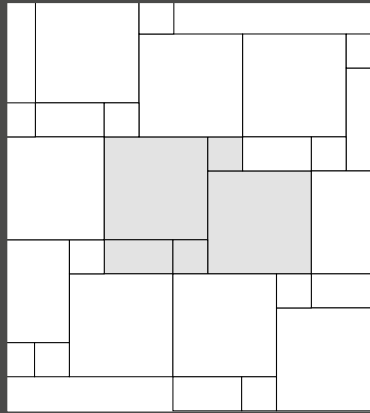

60,9x60,9=82%  
20,3x40,6=9%  
20,3x20,3=9%

J

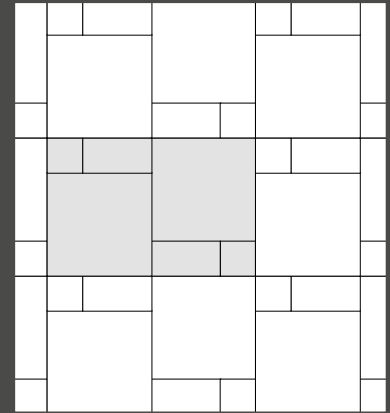

60,9x60,9=75%  
20,3x40,6=16,7%  
20,3x20,3=8,3%

K

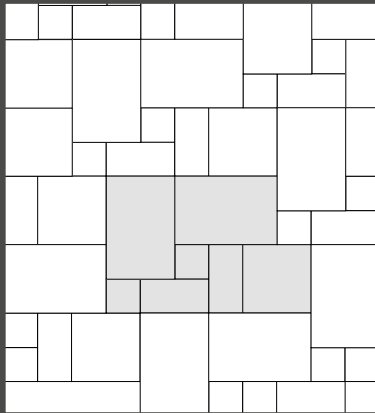

40,6x60,9=55%  
40,6x40,6=18%  
20,3x40,6=18%  
20,3x20,3=9%

L

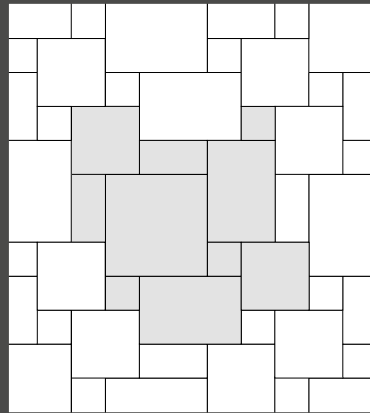

60,9x60,9=25%  
40,6x60,9=33,3%  
40,6x40,6=22,2%  
20,3x40,6=11,1%  
20,3x20,3=8,3%

M

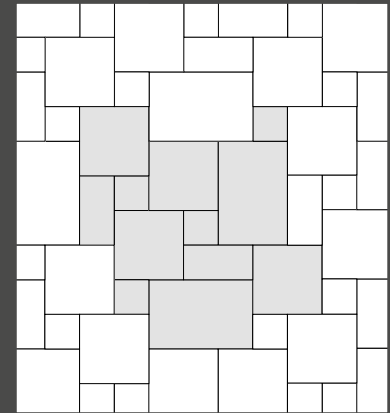

40,6x60,9=33,3%  
40,6x40,6=44,5%  
20,3x40,6=11,1%  
20,3x20,3=11,1%

N

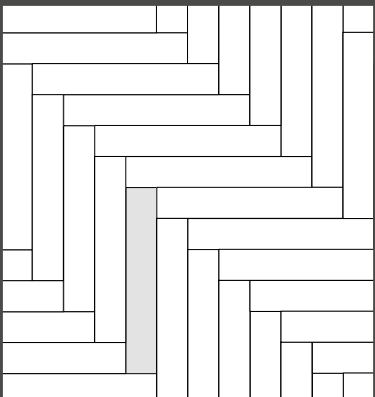

23x149=100%

O

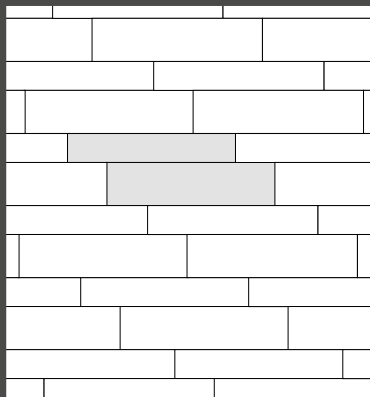

20x120=40%  
30x120=60%

P

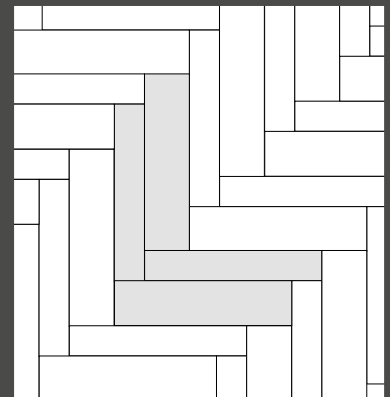

20x120=40%  
30x120=60%

Q







201016



201017



201018



201019

cod.	descrizione - description	conf. - pack	pallet
201016	<b>base + vite regolabile</b> da h. 28 a 39 mm <b>base + screw adjustable</b> from h. 28 to 39 mm	24	1152
201017	<b>base + vite regolabile</b> da h. 38 a 57 mm <b>base + screw adjustable</b> from h. 38 to 57 mm	24	1152
201018	<b>base + vite regolabile</b> da h. 56 a 91 mm <b>base + screw adjustable</b> from h. 56 to 91 mm	24	672
201019	<b>base + vite regolabile</b> da h. 87 a 150 mm <b>base + screw adjustable</b> from h. 87 to 150 mm	24	480

no sconfezionamento - no partial packaging



201020



201021

cod.	descrizione - description	conf. - pack	pallet
201020	<b>prolunga</b> h. 10 mm <b>extension</b> h. 10 mm	15	1800
201021	<b>prolunga</b> h. 80 mm <b>extension</b> h. 80 mm	24	960

no sconfezionamento - no partial packaging

201018 + 201021 = 136/195 mm

201019 + 201021 = 167/254 mm

201019 + (2 x 201021) = 247/358 mm

201019 + (3 x 201021) = 327/462 mm

201019 + (4 x 201021) = 407/566 mm

201019 + (5 x 201021) = 487/671 mm

201019 + (6 x 201021) = 567/775 mm

201019 + (7 x 201021) = 647/879 mm

201019 + (8 x 201021) = 727/983 mm

201019 + (9 x 201021) = 807/1087 mm

201019 + (10 x 201021) = 887/1192 mm

201022  
201023  
201024

cod.	descrizione - description	conf. - pack	pallet
201022	<b>testa fuga</b> 2 mm <b>head</b> for 2 mm joints	48	3840
201023	<b>testa fuga</b> 3 mm <b>head</b> for 3 mm joints	48	3840
201024	<b>testa fuga</b> 4 mm <b>head</b> for 4 mm joints	48	3840

no sconfezionamento - no partial packaging



201025

cod.	descrizione - description	conf. - pack	pallet
201025	<b>Testa fissa</b> fuga 4 mm <b>Fixed head</b> for 4-mm joints	48	3840

no sconfezionamento - no partial packaging

con testa fissa **cod. 201025** le escursioni delle basi + viti sono da considerarsi inferiori di 3 mm, quindi le altezze saranno:**cod. 201016:** da 25 a 36,**cod. 201017:** da 35 a 54,**cod. 201018:** da 53 a 88,**cod. 201019:** da 84 a 147*with fixed head **cod. 201025** the ranges of the bases + screws are to be considered 3 mm lower, therefore the heights will be:****cod. 201016:** from 25 to 36,****cod. 201017:** from 35 to 54,****cod. 201018:** from 53 to 88,****cod. 201019:** from 84 to 147*

201026



201027



201028

201029  
201030

201031

cod.	descrizione - description	conf. - pack	pallet
201026	<b>testa</b> per travetto in alluminio <b>head</b> for aluminium joist	48	3840
201027	<b>travetto in alluminio naturale</b> L. 240 cm <b>natural aluminium joist</b> L. 240 cm	8	-
201028	<b>distanziatore fuga 4 mm</b> per travetto cod. 201027 <b>4-mm spacer</b> for joist cod. 201027	500	-
201029	<b>gomma antirumore</b> per travetto cod. 201027 rotolo 50 metri <b>noise-proof rubber</b> for joist cod. 201027 - 50 meters roll	1	-
201030	<b>gomma antirumore</b> per travetto cod. 201027 rotolo 200 metri <b>noise-proof rubber</b> for joist cod. 201027 - 200 meters roll	1	-
201031	<b>giunto di raccordo</b> per travetto cod. 201027 <b>connection joint</b> for joist cod. 201027	250	-

no sconfezionamento - no partial packaging

cod.	descrizione - description	conf. - pack	pallet
201032	<b>supporto regolabile</b> da h. 10 a 15 mm <b>adjustable support</b> from h. 10 to 15 mm	20	-
201033	<b>prolunga h. 5 mm</b> per articolo con cod. 201032 (max 3 prolunghes = + 15 mm) <b>extension h. 5 mm</b> for item with cod. 201032 (max. 3 extensions = + 15 mm)	20	-

no sconfezionamento - no partial packaging



201032



201033



201034



201035



201036

cod.	descrizione - description	conf. - pack	pallet
201034	<b>supporto ad altezza fissa</b> diam. 155x14 h. <b>fixed height support</b> diam. 155 x 14 h.	360	5760
201035	<b>livellatore per supporto</b> cod. 201034 h. 1 mm <b>leveller for support</b> cod. 201034 - h. 1 mm	1000	20000
201036	<b>livellatore per supporto</b> cod. 201034 h. 3 mm <b>leveller for support</b> cod. 201034 - h. 3 mm	500	15000

no sconfezionamento - no partial packaging



201037



201038



201039



201040



201041



201042

cod.	descrizione - description	conf. - pack	pallet
201037	<b>chiave di regolazione</b> (per fughe 4 mm) <b>adjustment key</b> (for 4 mm joints)	12	-
201038	<b>inserto per trapano avvitatore</b> <b>insert for screwdriver drill</b>	1	-
201039	<b>clip perimetrale</b> (base + testa) <b>perimeter clip</b> (base + head)	30	-
201040	<b>clip angolare</b> (base + testa) <b>corner clip</b> (base + head)	4	-
201041	<b>clip muro</b> in acciaio inox <b>wall clip</b> in stainless steel	50	-
201042	<b>clip muro</b> in PoliPropilene nero <b>wall clip</b> in polypropylene	200	-
201043	<b>tappetino in gomma</b> diam. cm 21x0,2 sp. <b>rubber mat</b> diam. cm 21 x 0,2 thick.	100	-
201044	<b>disco livellante</b> per testa diam. cm 12x0,2 sp. <b>levelling disk</b> for head diam. cm 12 x 0,2 thick.	100	-
201045	<b>disco livellante</b> per base diam. cm 21x0,2 sp. <b>levelling disk</b> for base diam. cm 21 x 0,2 thick.	100	-



201043



201044



201045

no sconfezionamento (eccetto per chiave di regolazione cod. 201037)  
no partial packaging (except for adjustment key cod. 201037)

# IMBALLI LASTRE

Slabs Packaging

## Cavalletti

A-frame

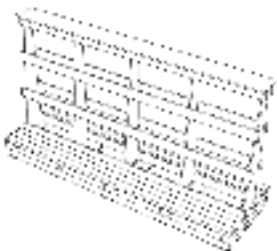

### WOOD A-FRAME

INGOMBRO - SIZE: 330x75x193,5 CM  
TARA - TARE: 177,50 KG

cod. 202011

Tiles dimension  
324x163 | 22 pieces  
320x160 | 44 pieces

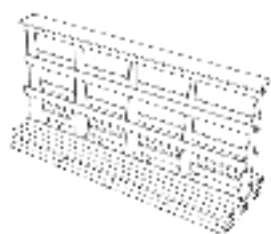

### WOOD A-FRAME

INGOMBRO - SIZE: 290x75x161 CM  
TARA - TARE: 145 KG

cod. 202009

Tiles dimension  
280x120 | 44 pieces

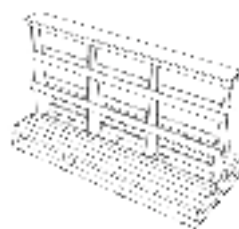

### WOOD A-FRAME

INGOMBRO - SIZE: 250x75x161 CM  
TARA - TARE: 132 KG

cod. 202010

Tiles dimension  
240x120 | 44 pieces

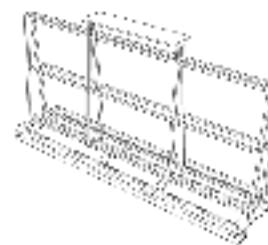

### IRON A-FRAME

INGOMBRO - SIZE: 330x75x193,5 CM  
TARA - TARE: 130 KG

cod. 202012

Tiles dimension  
324x163 | 22 pieces

## Cassa in legno

Wood crate



INGOMBRO - SIZE: 345x175x37 CM  
TARA - TARE: 140 KG

cod. 202002

Tiles dimension  
163x324 | 10 pieces  
160x320 | 14 pieces



INGOMBRO - SIZE: 292x145x35 CM  
TARA - TARE: 108 KG

cod. 202005

Tiles dimension  
120x280 | 20 pieces



INGOMBRO - SIZE: 264x136x40 CM  
TARA - TARE: 100 KG

cod. 202001

Tiles dimension  
120x240 | 20 pieces

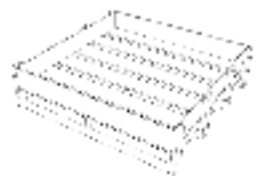

INGOMBRO - SIZE: 182,6x173,6x40,4 CM  
TARA - TARE: 80 KG

cod. 202003

Tiles dimension  
160x160 | 24 pieces



INGOMBRO - SIZE: 252x94x30,4 CM  
TARA - TARE: 85 KG

cod. 202006

Tiles dimension  
24x240 | 54 pieces  
40x240 | 36 pieces

**Paletta**  
Pallet



INGOMBRO - SIZE: 120x80x14,4 CM  
TARA - TARE: 22 KG

Tiles dimension  
20x120 | 30x120 | 40x120  
30x60 | 60x60 | 60x120  
20x40 | 40x40 | 40x60  
10x30

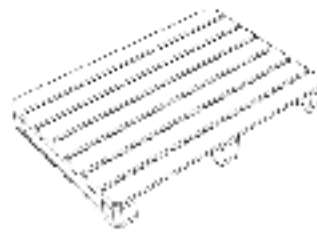

INGOMBRO - SIZE: 120x96x13,6 CM  
TARA - TARE: 20 KG

Tiles dimension  
60x120 Lapp

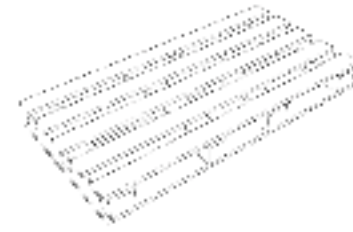

INGOMBRO - SIZE: 152x77,6x16,1 CM  
TARA - TARE: 20 KG

Tiles dimension  
23,4x148

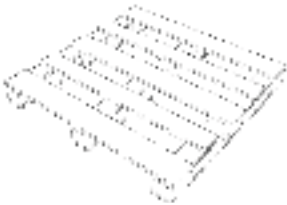

INGOMBRO - SIZE: 103x103x15 CM  
TARA - TARE: 22 KG

Tiles dimension  
100x100 h20

**Pallet con sponde**  
Pallet with sides



INGOMBRO - SIZE: 184x97x45 CM  
TARA - TARE: 36 KG

Tiles dimension  
80x180 | 40 pieces



INGOMBRO - SIZE: 168x97x40,9 CM  
TARA - TARE: 29,4 KG

Tiles dimension  
80x160 | 30 pieces



INGOMBRO - SIZE: 123x143x74 CM  
TARA - TARE: 29 KG

Tiles dimension  
120x120 | 48 pieces



INGOMBRO - SIZE: 103x123x70 CM  
TARA - TARE: 30 KG

Tiles dimension  
100x100 h8,8 | 48 pieces



FOLLOW US

ITALCER S.p.A. SB | P.IVA 00142060359

Amministrazione e Sede Legale  
*Accounting and Legal Head Office*

Via Emilia Ovest 53/A - 42048 Rubiera (RE) - Italy  
Tel. +39 0522 625111  
Fax +39 0522 625160

Uffici Commerciali e Showroom  
*Sales Department and Showroom*

Via Emilia Ponente 2070 - 48014 Castel Bolognese (RA) Italy  
Tel. +39 0546 - 659911 - Fax +39 0546 - 656223  
info@lafabbrica.it - www.lafabbrica.it