

LA
FABBRICA
AVA
EXTRAORDINARY TILES

Catalogo
generale

20
25

shape your space

Indice per Collezione

Collection index / Index par collection / Inhaltsverzeichnis nach Kollektionen

Marmo e Pietra

- 39 STATUARIO
- 47 STATUARIO REALE
- 55 BRECCIA CAPRAIA **NEW SERIES**
- 63 CALACATTA ORO
- 71 BIANCO IMPERIALE **NEW SERIES**
- 79 MACCHIA ANTICA
- 87 AVORIO SEGESTA **NEW SERIES**
- 95 TRAVERTINO CLASSIC
- 103 AESTHETICA HEGEL
- 111 AESTHETICA WILDE
- 119 GREEN SKY **NEW SERIES**
- 127 ONICE IRIDE
- 135 NAUTILUS
- 141 BRECCIA ARGENTUM
- 149 BRECCIA SICILIA **NEW SERIES**
- 157 BRONZE AMANI
- 165 SAHARA NOIR
- 171 BLACK GOLD **NEW SERIES**
- 179 DEEP STONE **NEW SERIES**
- 187 NOBLE STONE
- 197 BOLGHERI STONE
- 205 GEMSTONE
- 215 IMPERIAL
- 223 VELARIS **NEW SERIES**
- 235 PIERRES DES CHÂTEAUX
- 235 PIERRES DES CHÂTEAUX ADVANCE®
- 243 ROYAL STONE
- 249 CHIANGA
- 259 ARDESIA
- 267 STORM
- 275 DOLOMITI
- 283 BLUE EVOLUTION
- 289 I QUARZI
- 297 BORGHI ITALIANI

Materico

- 305 SKYLINE
- 313 HURBAN
- 321 ABSOLUTE
- 327 LE MALTE
- 335 SPACE
- 343 ARTILE
- 351 LASCAUX
- 357 COTTO DEL CASALE
- 365 KIST **NEW SERIES**
- 373 KIST LUX **NEW SERIES**
- 381 GROOVES **NEW SERIES**
- 389 UP
- 399 SMALL

Legno

- 411 HONEY WOOD **NEW SIZE**
- 431 IL CERRETO
- 431 IL CERRETO ADVANCE®
- 439 AMAZON
- 447 CA' FOSCARI
- 455 KAURI

Design

- 465 SCRATCH
- 473 IMAGINE

Indice Generale

General index / Index général / Allgemeiner Index

- 4 **INDICE PER FORMATO**
Index by size
Index par taille
Index nach Format
- 6 **INDICE PER FORMATO / OUTDOOR**
Index by size / Outdoor
Index par taille / Outdoor
Index nach Format / Outdoor
- 7 **INDICE PER DESTINAZIONE D'USO**
Table of contents broken down according to intended use
Index par destination d'usage
Index für Verwendungszweck
- 8 **OVERVIEW
GRANDI FORMATI I**
Grands formats
Grands formats
Großformate
- 26 **LA FABBRICA AVA & IL GRUPPO ITALCER**
- 28 **LE TAPPE**
The stages
Les étapes
Die Etappen
- 30 **ITALCER GROUP SOCIETÀ BENEFIT**
Italcer Group, a Benefit Company
Italcer Group, une Benefit Corporation
Italcer Group, eine Benefit-Gesellschaft
- 32 **IL CONTRIBUTO DI ITALCER GROUP
AGLI OBIETTIVI DI SVILUPPO SOSTENIBILE**
Italcer Group's contribution to the Sustainable Development Goals
La contribution du Groupe Italcer aux objectifs du développement durable
Engagement der Italcer Group für nachhaltige Entwicklung
- 34 **ITALCER GROUP PREMIATO
AL SUSTAINABILITY AWARD 2024**
Italcer Group wins Sustainability Award 2024
Italcer Group récompensé aux Sustainability Awards 2024
Italcer Group gewinnt den Sustainability Award 2024
- 37 **MARMO E PIETRA**
- 303 **MATERICO**
- 409 **LEGNO**
- 463 **DESIGN**
- 499 **PARTE TECNICA**
Technical Section
Partie Technique
Technischer Teil

Indice per Formato

Index by size / Index par taille / Index nach Format

6 mm

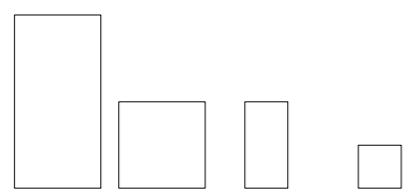

| | 160x320 63"x126" | 160x160 63"x63" | 80x160 31½"x63" | 80x80 31½"x31½" | 120x280 48"x110" | 40x240 16"x96" | 24x240 9½"x96" | 120x120 48"x48" | 60x120 24"x48" | Pag. |
|-----------------------------|---------------------|--------------------|--------------------|--------------------|---------------------|-------------------|-------------------|--------------------|-------------------|------|
| ABSOLUTE | ✓ | ✓ | ✓ | ✓ | ✓ | - | - | ✓ | - | 321 |
| AESTHETICA HEGEL | ✓ | - | - | - | ✓ | - | - | ✓ | - | 103 |
| AESTHETICA WILDE | ✓ | - | - | - | ✓ | - | - | ✓ | - | 111 |
| AVORIO SEGESTA NEW | - | - | - | - | ✓ | - | - | - | - | 87 |
| BIANCO IMPERIALE NEW | - | - | - | - | ✓ | - | - | - | - | 71 |
| BLACK GOLD NEW | - | - | - | - | ✓ | - | - | - | - | 171 |
| BOLGHERI STONE | - | - | - | - | ✓ | - | - | - | - | 197 |
| BRECCIA ARGENTUM | ✓ | - | - | - | ✓ | - | - | ✓ | - | 141 |
| BRECCIA CAPRAIA NEW | - | - | - | - | ✓ | - | - | - | - | 55 |
| BRECCIA SICILIA NEW | - | - | - | - | ✓ | - | - | - | - | 149 |
| BRONZE AMANI | - | - | - | - | ✓ | - | - | - | - | 157 |
| CALACATTA ORO | ✓ | - | - | - | ✓ | - | - | ✓ | - | 63 |
| DEEP STONE NEW | - | - | - | - | ✓ | - | - | - | - | 179 |
| GEMSTONE | - | - | - | - | ✓ | - | - | - | - | 205 |
| GREEN SKY NEW | - | - | - | - | ✓ | - | - | - | - | 119 |
| HONEY WOOD | - | - | - | - | - | ✓ | ✓ | - | - | 411 |
| HURBAN | - | - | - | - | ✓ | - | - | ✓ | - | 313 |
| IMAGINE | - | - | - | - | ✓ | - | - | - | - | 473 |
| LE MALTE | - | - | - | - | ✓ | - | - | ✓ | ✓ | 327 |
| MACCHIA ANTICA | ✓ | - | - | - | ✓ | - | - | ✓ | - | 79 |
| NAUTILUS | ✓ | - | - | - | ✓ | - | - | ✓ | - | 135 |
| NOBLE STONE | - | - | - | - | ✓ | - | - | ✓ | - | 187 |
| ONICE IRIDE | ✓ | - | ✓ | - | ✓ | - | - | ✓ | - | 127 |
| SAHARA NOIR | - | - | - | - | ✓ | - | - | - | - | 165 |
| SCRATCH | ✓ | ✓ | ✓ | ✓ | ✓ | - | - | - | - | 465 |
| SKYLINE | ✓ | ✓ | ✓ | ✓ | ✓ | - | - | ✓ | - | 305 |
| STATUARIO | ✓ | - | - | - | ✓ | - | - | ✓ | - | 39 |
| STATUARIO REALE | ✓ | - | - | - | ✓ | - | - | ✓ | - | 47 |
| TRAVERTINO CLASSIC | - | - | - | - | ✓ | - | - | - | - | 95 |
| VELARIS NEW | - | - | - | - | ✓ | - | - | - | - | 223 |

8,8 mm

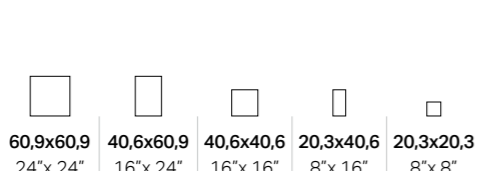

| | 60,9x60,9 24"x 24" | 40,6x60,9 16"x 24" | 40,6x40,6 16"x 16" | 20,3x40,6 8"x 16" | 20,3x20,3 8"x 8" | 23,4x148 9"x 58 ½" | 30x120 12"x48" | 20x120 8"x48" | 15x85 6"x33½" | 7,5x40,7 3"x16" | 7,5x45 3"x18" | Pag. |
|---------------------|-----------------------|-----------------------|-----------------------|----------------------|---------------------|-----------------------|-------------------|------------------|------------------|--------------------|------------------|------|
| AMAZON | - | - | - | - | - | - | - | ✓ | - | ✓ | ✓ | 439 |
| ARTILE | - | - | - | - | - | - | - | ✓ | - | - | - | 343 |
| CA' FOSCARI | - | - | - | - | - | - | - | ✓ | - | ✓ | ✓ | 447 |
| CHIANCA | ✓ | ✓ | ✓ | ✓ | ✓ | - | - | - | - | - | - | 249 |
| COTTO DEL CASALE | ✓ | ✓ | ✓ | ✓ | ✓ | - | - | - | - | - | - | 357 |
| HONEY WOOD | - | - | - | - | - | - | ✓ | ✓ | ✓ | ✓ | - | 411 |
| IL CERRETO | - | - | - | - | - | ✓ | ✓ | ✓ | - | - | - | 431 |
| IL CERRETO ADVANCE® | - | - | - | - | - | ✓ | - | - | - | - | - | 431 |
| KAURI | - | - | - | - | - | - | - | ✓ | - | ✓ | ✓ | 455 |
| LASCAUX | - | - | - | - | - | - | ✓ | ✓ | - | - | - | 351 |

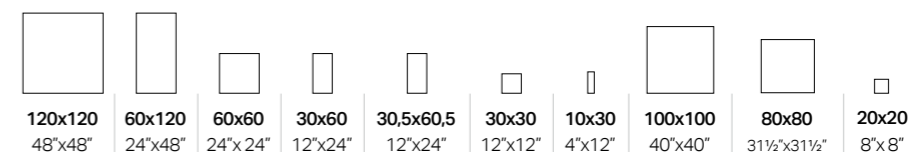

8,8 mm

| | 120x120 48"x48" | 60x120 24"x48" | 60x60 24"x24" | 30x60 12"x24" | 30,5x60,5 12"x24" | 30x30 12"x12" | 10x30 4"x12" | 100x100 40"x40" | 80x80 31½"x31½" | 20x20 8"x8" | Pag. |
|-------------------------------|--------------------|-------------------|------------------|------------------|----------------------|------------------|-----------------|--------------------|--------------------|----------------|------|
| ABSOLUTE | - | ✓ | ✓ | - | - | - | - | - | - | - | 321 |
| AESTHETICA HEGEL | - | ✓ | - | - | - | - | - | - | - | - | 103 |
| AESTHETICA WILDE | - | ✓ | - | - | - | - | - | - | - | - | 111 |
| ARDESIA | - | ✓ | ✓ | ✓ | ✓ | - | - | - | ✓ | - | 259 |
| ARTILE | - | ✓ | ✓ | ✓ | - | - | - | - | - | - | 343 |
| AVORIO SEGESTA NEW | - | ✓ | - | - | - | - | - | - | - | - | 87 |
| BIANCO IMPERIALE NEW | - | ✓ | - | - | - | - | - | - | - | - | 71 |
| BLACK GOLD NEW | - | ✓ | - | - | - | - | - | - | - | - | 171 |
| BOLGHERI STONE | - | ✓ | ✓ | - | - | - | - | - | - | - | 197 |
| BRECCIA ARGENTUM | - | ✓ | - | - | - | - | - | - | - | - | 141 |
| BRECCIA CAPRAIA NEW | - | ✓ | - | - | - | - | - | - | - | - | 55 |
| BRECCIA SICILIA NEW | - | ✓ | - | - | - | - | - | - | - | - | 149 |
| BRONZE AMANI | - | ✓ | - | - | - | - | - | - | - | - | 157 |
| CALACATTA ORO | - | ✓ | - | - | - | - | - | - | - | - | 63 |
| CHIANCA | - | ✓ | - | - | - | - | - | ✓ | - | - | 249 |
| DEEP STONE NEW | - | ✓ | ✓ | ✓ | - | - | - | - | - | - | 179 |
| DOLOMITI | - | ✓ | ✓ | ✓ | ✓ | - | - | - | - | - | 275 |
| GEMSTONE | - | ✓ | ✓ | ✓ | - | - | - | - | - | - | 205 |
| GREEN SKY NEW | - | ✓ | - | - | - | - | - | - | - | - | 119 |
| HURBAN | - | ✓ | ✓ | ✓ | - | - | - | ✓ | - | - | 313 |
| I QUARZI | - | - | ✓ | ✓ | ✓ | ✓ | - | - | - | - | 289 |
| IMAGINE | - | ✓ | - | - | - | - | - | - | - | - | 473 |
| IMPERIAL | ✓ | ✓ | ✓ | ✓ | - | - | ✓ | - | - | - | 215 |
| KAURI | - | ✓ | - | - | - | - | - | - | - | - | 455 |
| LASCAUX | - | ✓ | ✓ | ✓ | - | - | - | - | - | - | 351 |
| LE MALTE | - | - | - | - | - | - | - | - | ✓ | - | 327 |
| MACCHIA ANTICA | - | ✓ | - | - | - | - | - | - | - | - | 79 |
| NOBLE STONE | - | ✓ | ✓ | ✓ | - | - | - | ✓ | - | - | 187 |
| ONICE IRIDE | - | ✓ | - | - | - | - | - | - | - | - | 127 |
| PIERRES DES CHÂTEAUX | - | ✓ | ✓ | ✓ | - | - | ✓ | ✓ | - | - | 235 |
| PIERRES DES CHÂTEAUX ADVANCE® | - | ✓ | ✓ | ✓ | - | - | - | ✓ | - | - | 235 |
| ROYAL STONE | - | ✓ | ✓ | ✓ | ✓ | - | - | ✓ | - | - | 243 |
| SAHARA NOIR | - | ✓ | - | - | - | - | - | - | - | - | 165 |
| SCRATCH | - | ✓ | - | - | - | - | - | - | - | - | 465 |
| SKYLINE | - | ✓ | ✓ | - | - | - | - | - | ✓ | - | 305 |
| SPACE | - | ✓ | ✓ | ✓ | - | - | - | - | ✓ | ✓ | 335 |
| STATUARIO | - | ✓ | ✓ | - | - | - | - | - | - | - | 39 |
| STATUARIO REALE | - | ✓ | - | - | - | - | - | - | - | - | 47 |
| STORM | - | ✓ | ✓ | ✓ | - | - | - | - | - | - | 267 |
| TRAVERTINO CLASSIC | - | ✓ | - | - | - | - | - | - | - | - | 95 |
| VELARIS NEW | ✓ | ✓ | ✓ | ✓ | - | - | - | - | - | - | 223 |

9 mm

| | 12,4x10,7 5"x4¼" | 10x10 4"x4" | 5x25 2"x10" | 6,5x20 2½"x8" | 7,5x15 3"x6" | 5,1x16,1 2"x6½" | Jolly 1,2x20 ½"x8" | Pencil bullnose 3x20 1¼"x8" | Pag. |
|--------------------|---------------------|----------------|----------------|------------------|-----------------|--------------------|-----------------------|--------------------------------|------|
| GROOVES NEW | - | - | - | - | ✓ | - | ✓ | - | 381 |
| SMALL | ✓ | ✓ | - | ✓ | - | ✓ | ✓ | ✓ | 399 |
| UP | - | ✓ | ✓ | - | - | - | ✓ | - | 389 |

9,5 mm

| | 4,8x45 2"x18" | Pag. |
|---------------------|------------------|------|
| KIST NEW | ✓ | 365 |
| KIST LUX NEW | ✓ | 373 |

Indice per Formato Outdoor

Index by size Outdoor

Index par taille Outdoor

Index nach Format Outdoor

| OUTDOOR 8,8 mm R11C | | | | | | | | | | | | | | Pag. |
|---------------------------|-------------------|------------------|------------------|----------------------|------------------|--------------------|--------------------|----------------------|----------------------|----------------------|---------------------|--------------------|------------------|------|
| | 60x120 24"x48" | 60x60 24"x24" | 30x60 12"x24" | 30,5x60,5 12"x24" | 30x30 12"x12" | 100x100 40"x40" | 80x80 31½"x31½" | 60,9x60,9 24"x24" | 40,6x60,9 16"x24" | 40,6x40,6 16"x16" | 20,3x40,6 8"x16" | 20,3x20,3 8"x8" | 20x120 8"x48" | |
| ARDESIA | ✓ | - | - | - | - | - | ✓ | - | - | - | - | - | - | 259 |
| BORGHI ITALIANI | - | - | - | - | - | - | - | - | ✓ | ✓ | ✓ | ✓ | - | 297 |
| CA' FOSCARI | - | - | - | - | - | - | - | - | - | - | - | - | ✓ | 447 |
| CHIANCA | - | - | - | - | - | ✓ | - | ✓ | ✓ | ✓ | ✓ | ✓ | - | 249 |
| COTTO DEL CASALE | - | - | - | - | - | - | - | ✓ | ✓ | ✓ | ✓ | ✓ | - | 357 |
| DOLOMITI | ✓ | ✓ | - | ✓ | - | - | - | - | - | - | - | - | - | 275 |
| HONEY WOOD | - | - | - | - | - | - | - | - | - | - | - | - | ✓ | 411 |
| HURBAN | - | - | - | - | - | ✓ | - | - | - | - | - | - | - | 313 |
| I QUARZI | - | ✓ | ✓ | ✓ | ✓ | - | - | - | - | - | ✓ | - | - | 289 |
| IL CERRETO | - | - | - | - | - | - | - | - | - | - | - | - | ✓ | 431 |
| NOBLE STONE | ✓ | - | - | - | - | - | - | - | - | - | - | - | - | 187 |
| PIERRES DES CHÂTEAUX | - | - | - | - | - | ✓ | - | - | - | - | - | - | - | 235 |
| SKYLINE | - | - | - | - | - | ✓ | - | - | - | - | - | - | - | 305 |
| SPACE | - | - | - | - | - | - | ✓ | - | - | - | - | - | - | 335 |
| STORM | - | - | - | ✓ | - | - | - | - | - | - | - | - | - | 267 |

| OUTDOOR 20 mm R11C | | | | | | Pag. |
|--------------------------|-------------------|-------------------|--------------------|--------------------|------------------|------|
| | 60x120 24"x48" | 40x120 16"x48" | 100x100 40"x40" | 80x80 31½"x31½" | 60x60 24"x24" | |
| AMAZON | - | ✓ | - | - | - | 439 |
| ARDESIA | - | ✓ | - | ✓ | - | 259 |
| BLUE EVOLUTION | - | - | - | ✓ | - | 283 |
| CA' FOSCARI | - | ✓ | - | - | - | 447 |
| CHIANCA | - | - | ✓ | - | - | 249 |
| DOLOMITI | - | ✓ | - | - | - | 275 |
| HONEY WOOD | - | ✓ | - | - | - | 411 |
| HURBAN | - | - | ✓ | - | - | 313 |
| I QUARZI | - | - | - | - | ✓ | 289 |
| IL CERRETO | - | ✓ | - | - | - | 431 |
| NOBLE STONE | ✓ | - | - | - | - | 187 |
| PIERRES DES CHÂTEAUX | - | - | ✓ | - | - | 235 |
| ROYAL STONE | - | - | ✓ | - | ✓ | 243 |
| SKYLINE | - | - | ✓ | - | - | 305 |
| SPACE | - | - | - | ✓ | - | 335 |
| STORM | - | - | - | ✓ | ✓ | 267 |
| VELARIS NEW | ✓ | - | - | - | - | 223 |

Indice per Destinazione d'uso

Table of contents broken down according to intended use

Index par destination d'usage

Index für Verwendungszweck

| Indoor | | R11C 8,8 mm | | Outdoor R11C 20 mm | | |
|----------|-------------------------------|-------------|----------------------|--------------------|----------------------|-----|
| A | ABSOLUTE | 321 | | | | |
| | AESTHETICA HEGEL | 103 | | | | |
| | AESTHETICA WILDE | 111 | | | | |
| | AMAZON | 439 | | AMAZON | 439 | |
| | ARDESIA | 259 | ARDESIA | 259 | ARDESIA | 259 |
| | ARTILE | 343 | | | | |
| | AVORIO SEGESTA NEW | 87 | | | | |
| B | BIANCO IMPERIALE NEW | 71 | | | | |
| | BLACK GOLD NEW | 171 | | | | |
| | | | | BLUE EVOLUTION | 283 | |
| | BOLGHERI STONE | 197 | | | | |
| | | | BORGHI ITALIANI | 297 | | |
| | BRECCIA ARGENTUM | 141 | | | | |
| | BRECCIA CAPRAIA NEW | 55 | | | | |
| | BRECCIA SICILIA NEW | 149 | | | | |
| | BRONZE AMANI | 157 | | | | |
| C | CA' FOSCARI | 447 | CA' FOSCARI | 447 | CA' FOSCARI | 447 |
| | CALACATTA ORO | 63 | | | | |
| | CHIANCA | 249 | CHIANCA | 249 | CHIANCA | 249 |
| | COTTO DEL CASALE | 357 | COTTO DEL CASALE | 357 | | |
| D | DEEP STONE NEW | 179 | | | | |
| | DOLOMITI | 275 | DOLOMITI | 275 | DOLOMITI | 275 |
| G | GEMSTONE | 205 | | | | |
| | GREEN SKY NEW | 119 | | | | |
| | GROOVES | 381 | | | | |
| H | HONEY WOOD | 411 | HONEY WOOD | 411 | HONEY WOOD | 411 |
| | HURBAN | 313 | HURBAN | 313 | HURBAN | 313 |
| I | I QUARZI | 289 | I QUARZI | 289 | I QUARZI | 289 |
| | IL CERRETO | 431 | IL CERRETO | 431 | IL CERRETO | 431 |
| | IL CERRETO ADVANCE® | 431 | | | | |
| | IMAGINE | 473 | | | | |
| | IMPERIAL | 215 | | | | |
| K | KAURI | 455 | | | | |
| | KIST NEW | 365 | | | | |
| | KIST LUX NEW | 373 | | | | |
| L | LASCAUX | 351 | | | | |
| | LE MALTE | 327 | | | | |
| M | MACCHIA ANTICA | 79 | | | | |
| N | NAUTILUS | 135 | | | | |
| | NOBLE STONE | 187 | NOBLE STONE | 187 | NOBLE STONE | 187 |
| O | ONICE IRIDE | 127 | | | | |
| P | PIERRES DES CHÂTEAUX | 235 | PIERRES DES CHÂTEAUX | 235 | PIERRES DES CHÂTEAUX | 235 |
| | PIERRES DES CHÂTEAUX ADVANCE® | 235 | | | | |
| R | ROYAL STONE | 243 | | | | |
| S | SAHARA NOIR | 165 | | | | |
| | SCRATCH | 465 | | | | |
| | SKYLINE | 305 | SKYLINE | 305 | SKYLINE | 305 |
| | SMALL | 399 | | | | |
| | SPACE | 335 | SPACE | 335 | SPACE | 335 |
| | STATUARIO | 39 | | | | |
| | STATUARIO REALE | 47 | | | | |
| | STORM | 267 | STORM | 267 | STORM | 267 |
| T | TRAVERTINO CLASSIC | 95 | | | | |
| U | UP | 389 | | | | |
| V | VELARIS NEW | 223 | | | VELARIS | 223 |

Overview

Grandi Formati

Grands formats
Grands formats
Großformate

160X320
63"X126"

120X280
48"X110"

Marmo e Pietra



pag. 39

STATUARIO

160x320_63"x126"
120x280_48"x110"

pag. 47

**STATUARIO
REALE**

160x320_63"x126"
120x280_48"x110"

pag. 55

NEW
**BRECCIA
CAPRAIA**

120x280_48"x110"

pag. 63

**CALACATTA
ORO**

160x320_63"x126"
120x280_48"x110"

pag. 71

NEW
**BIANCO
IMPERIALE**

120x280_48"x110"

pag. 79

**MACCHIA
ANTICA**

160x320_63"x126"
120x280_48"x110"

pag. 87

NEW
**AVORIO
SEGESTA**

120x280_48"x110"

pag. 95

**TRAVERTINO
CLASSIC**

120x280_48"x110"



HEGEL

WILDE

GIADA

MALAGA

AMBRA

AVORIO

ARGENTO

COBALTO

pag. 103

pag. 111

pag. 119

pag. 127

pag. 127

pag. 135

pag. 141

pag. 149

NEW

AESTHETICA

GREEN SKY

**ONICE
IRIDE**

**ONICE
IRIDE**

NAUTILUS

**BRECCIA
ARGENTUM**

NEW
**BRECCIA
SICILIA**

160x320_63"x126"

120x280_48"x110"

120x280_48"x110"

120x280_48"x110"

160x320_63"x126"

120x280_48"x110"

160x320_63"x126"

120x280_48"x110"

160x320_63"x126"

120x280_48"x110"

120x280_48"x110"

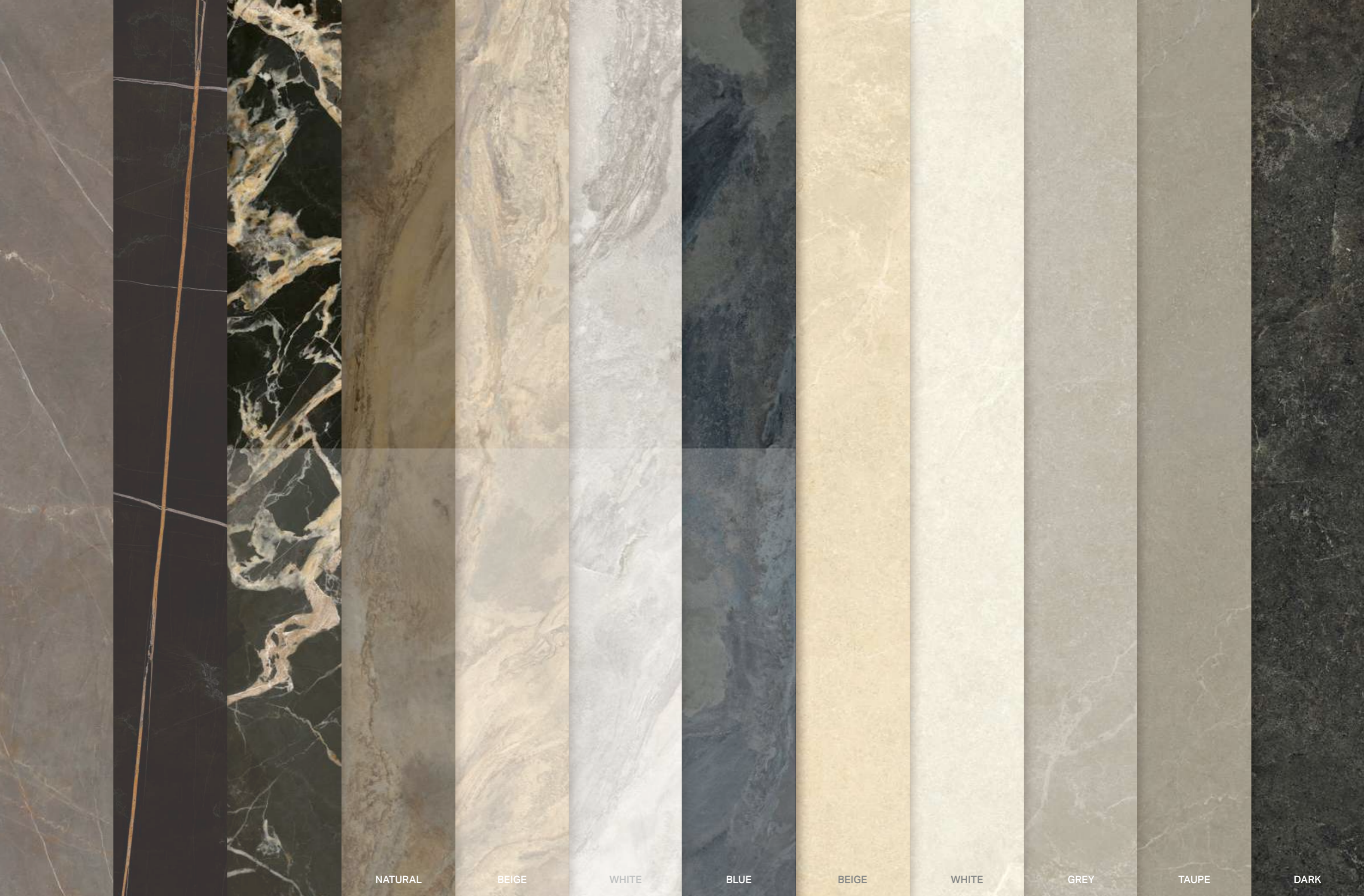

NATURAL

BEIGE

WHITE

BLUE

BEIGE

WHITE

GREY

TAUPE

DARK

pag. 157

pag. 165

pag. 171

NEW

**BRONZE
AMANI**

**SAHARA
NOIR**

**BLACK
GOLD**

pag. 179

NEW

**DEEP
STONE**

pag. 187

**NOBLE
STONE**

120x280_48"x110"

120x280_48"x110"

120x280_48"x110"

120x280_48"x110"

120x280_48"x110"



BEIGE

NATURAL

WHITE

SAGE

OCEAN

GREY

NATURAL

DESERT

pag. 197

**BOLGHERI
STONE**

120x280_48"x110"

pag. 205

GEMSTONE

120x280_48"x110"



Overview

Grandi Formati

Grands formats
Grands formats
Großformate

160X320
63"x126"

120X280
48"x110"

Materico

ANTRACITE

FUMO

GHIACCIO

BEIGE

GRAPHITE

GRAY

AVIO

WHITE

BEIGE

OCRA

pag. 305

SKYLINE

160x320_63"x126"

120x280_48"x110"

pag. 313

HURBAN

120x280_48"x110"

WHITE

BLACK

GREY

TAUPE

BEIGE

IVORY

SAGE

AVIO

pag. 321

ABSOLUTE

160x320_63"x126"

120x280_48"x110"

pag. 327

LE MALTE

120x280_48"x110"



Overview

Grandi Formati

Grands formats
Grands formats
Großformate

40X240
63"x96"

24X240
9 1/2"x96"

Legno

NOCE

ROVERE

OLMO

BRICOLA

LARICE

pag. 411

HONEY WOOD

40x240_16"x96"
24x240_9 1/2"x96"



Overview

Grandi Formati

Grands formats
Grands formats
Großformate

160X320
63"X126"

120X280
48"X110"

FUKSAS

Designers: Doriana and Massimiliano Fuksas



Design



LIGHT GRAFFITI

DARK GRAFFITI

MOONLIGHT

SUPERLUNA

ECLIPSE

MILKYWAY

pag. 465

SCRATCH

160x320_63"x126"
120x280_48"x110"



Overview

Grandi Formati

Grands formats
Grands formats
Großformate

120x280
48"x110"

Design



KENZIA

BOTANICAL

PLUMAGE

NAIF

PARADISE

JUNGLE CHIC

SHADOW LEAVES

AUTUMN

ARECA

pag. 473

IMAGINE

120x280_48"x110"

LA FABBRICA AVA & Italcer Group



Le tappe

Il Gruppo Italcer

- *Italcer Group, Società Benefit*
 - *Il contributo di Italcer Group agli obiettivi di sviluppo sostenibile*
 - *Italcer Group premiato al Sustainability Award 2024*
-

The stages

Italcer Group

- *Italcer Group, a Benefit Company*
 - *Italcer Group's contribution to the Sustainable Development Goals*
 - *Italcer Group wins Sustainability Award 2024*
-

Les étapes

Italcer Group

- *Italcer Group, une Benefit Corporation*
 - *La contribution du Groupe Italcer aux objectifs du Développement Durable*
 - *Italcer Group récompensé aux Sustainability Awards 2024*
-

Die etappen

Italcer Group

- *Italcer Group, eine Benefit-Gesellschaft*
 - *Engagement der Italcer Group für nachhaltige Entwicklung*
 - *Italcer Group gewinnt den Sustainability Award 2024*
-

Scarica il Bilancio di Sostenibilità
Download the Sustainability Report
Télécharger le Rapport de Durabilité
Laden Sie den Nachhaltigkeitsbericht herunter



Le tappe

The stages / Les étapes / Die etappen

Devon&Devon S.p.A., acquisita nell'ottobre 2017, è leader mondiale nell'arredo bagno alto di gamma in stile classico-contemporaneo.

Devon&Devon S.p.A., acquired in October 2017, is a world leader in high-end bathroom furniture with a classic-contemporary style.

Devon&Devon

2017

**LA FABBRICA
AVA**
EXTRAORDINARY TILES

La Fabbrica S.p.A., società fondata a Castel Bolognese (RA) e specializzata nelle ceramiche di alta qualità per pavimenti e rivestimenti sia da interno che da esterno, viene acquisita da Italcser Group nel marzo 2017 e fusa per incorporazione nella controllante Italcser S.p.A. SB con efficacia dal 1 gennaio 2024.

La Fabbrica S.p.A., a company founded in Castel Bolognese (RA) specialising in high-quality ceramics for both indoor and outdoor flooring and walls, was acquired by Italcser Group in March 2017 and merged into the parent company Italcser S.p.A. benefit company, effective 1 January 2024.

ELIOS
ceramica

Elios Ceramica S.p.A., con sede a Fiorano Modenese (MO), acquisita nell'agosto 2017 e successivamente fusa per incorporazione nella controllante Italcser S.p.A.

Elios Ceramica S.p.A., based in Fiorano Modenese (MO), was acquired in August 2017 and subsequently merged into the parent company Italcser S.p.A.

2024

Italcser USA è stata fondata nel dicembre 2018 per servire il mercato americano con linee di prodotto dedicate.

Italcser USA was founded in December 2018 to serve the American market with dedicated product lines.

ITALCER
USA

2018

**CERAMICA
Rondine**

Rondine S.p.A., fondata nel 1961 a Rubiera (RE), è entrata a far parte di Italcser Group nell'ottobre 2018 e dal 2019 ha assunto la denominazione di Italcser S.p.A..

Con l'acquisizione di Rondine, è entrata a far parte di Italcser Group anche la società sassolese Spray Dry S.p.A. (controllata al 100% da Rondine dal 2005), produttrice di impasto atomizzato, che ha consentito dapprima alla stessa Rondine e, successivamente, a Italcser Group di compiere un importante salto di qualità realizzando internamente l'intero ciclo produttivo della ceramica.

Rondine S.p.A., founded in 1961 in Rubiera (RE), became part of Italcser Group in October 2018 and adopted the name Italcser S.p.A. in 2019.

With the acquisition of Rondine, the Sassuolo-based company Spray Dry S.p.A. (wholly owned by Rondine since 2005) also became part of Italcser Group. The company produces atomised powder, which first allowed Rondine, and then Italcser Group, to make an important qualitative leap by internalising the entire ceramic production cycle.

Oggi Italcser Group è in grado di produrre nei propri stabilimenti dai piccolissimi formati alle grandissime lastre, attraverso marchi fortemente complementari in termini di dimensioni, stile, posizionamento e clienti target.

Un importante vantaggio competitivo.

Nell'agosto del 2019, Bottega S.p.A. entra a far parte di Italcser Group, venendo successivamente fusa per incorporazione in Italcser S.p.A.

In August 2019, Bottega S.p.A. became part of Italcser Group, subsequently merged by acquisition into Italcser S.p.A.

BOTTEGA

2019

2021

EQUIPE

Nel marzo 2021 continua la strategia di espansione ed internazionalizzazione di Italcser Group mediante l'acquisizione di Equipe Cerámicas S.L.U., fondata nel 1999 a Figueroles, Castellon, che si presenta oggi come l'azienda leader mondiale nel mercato dei pavimenti e dei rivestimenti di piccolo formato.

In March 2021, the Italcser Group expansion and internationalisation strategy continued with the acquisition of Equipe Cerámicas S.L.U., founded in 1999 in Figueroles, Castellón, which today is the world's leading company in the small floor and wall tile market.

Today Italcser Group manufactures products in house ranging from very small formats to very large slabs under brands that are highly complementary in terms of size, shape, positioning and target clientele.

This is an important competitive advantage.

Nell'ottobre 2022 Italcser Group completa il proprio portafoglio prodotti grazie all'acquisizione di Ceramica Fondovalle S.p.A., società fondata nel 1962, oggi leader di mercato nella produzione e commercializzazione di grandi e grandissime lastre in gres porcellanato.

In October 2022, Italcser Group completed its product portfolio with the acquisition of Ceramica Fondovalle S.p.A., a company founded in 1962 and today a market leader in the production and sale of large and very large porcelain stoneware slabs.

FONDOVALLE

2022

2023

TERRATINTA
group 

A fine 2023 Italcser Group si espande ulteriormente acquisendo Terratinta Group S.r.l. SB, società specializzata nell'alto di gamma delle superfici di arredo con sede a Fiorano Modenese in provincia di Modena.

In late 2023, Italcser Group expanded further by acquiring Terratinta Group S.r.l. benefit company, a company specialising in high-end furnishing surfaces based in Fiorano Modenese in the Province of Modena.

ITALCER
GROUP
DESIGN SURFACES

Italcer Group Società Benefit

Nell'ottobre 2023 Italcer S.p.A., quale capofila del Gruppo, ha assunto la qualifica di Società Benefit diventando Italcer Società per Azioni Società Benefit.

Tale trasformazione implica un'assunzione ulteriore di responsabilità del Consiglio di Amministrazione e della dirigenza di Italcer S.p.A. SB verso persone, comunità, territori ed ambiente nel quale la società opera, e ha richiesto l'inserimento nel proprio statuto sociale, ad integrazione dei consueti obiettivi di profitto, degli obiettivi di beneficio comune elencati di seguito:

- la riduzione delle emissioni di gas climalteranti nei processi aziendali;
- lo sviluppo di politiche aziendali di cattura delle emissioni aziendali di gas effetto-serra;
- l'incremento dell'impiego di energia da fonti rinnovabili anche attraverso l'autoproduzione di energia da fotovoltaico;
- la riduzione dei consumi attraverso interventi di efficientamento energetico, ad esempio attraverso l'autoproduzione di energia elettrica con cogenerazione ad alto rendimento e recupero di calore nel ciclo produttivo;
- la costante innovazione di prodotto in grado di proporre politiche aziendali di economia circolare e di ottimizzazione dei consumi energetici e delle risorse a beneficio del territorio di riferimento;
- l'attuazione di politiche di welfare aziendale e territoriale a beneficio dei propri dipendenti;
- lo sviluppo di percorsi di costante attenzione ai processi produttivi industriali, con un focus particolare sulla sicurezza sul lavoro;
- l'identificazione dell'impresa come soggetto di riferimento aggregativo sul territorio per i portatori di interesse delle comunità locali di riferimento;
- la promozione della cultura della diversità e della inclusione internamente alla Società e sul territorio ove opera.

Tali obiettivi riflettono formalmente l'impegno che il nostro Gruppo profonde quotidianamente verso le tematiche ambientali, sociali e di governance (ESG). A seguito della suddetta trasformazione è stato nominato dal Consiglio di Amministrazione un "responsabile dell'Impatto" della Società, a cui è stata formalmente attribuita la responsabilità di attuare, in ossequio alle disposizioni della dirigenza, il monitoraggio e la rendicontazione degli obiettivi di impatto sociale, individuando all'uopo modalità e criteri appropriati.

Italcer Group, a Benefit Company

In October 2023 Italcer S.p.A., as parent company of the Group, assumed the status of a benefit company, officially becoming Italcer Società per Azioni Società Benefit. This transformation implies further responsibilities taken by the Italcer S.p.A. benefit company Board of Directors and management towards people, communities, territories and the environment where the company operates. In addition to the usual profit objectives, it also requested inclusion of the common benefit objectives listed below in its Articles of Association:

- *reducing emissions of climate-altering gases in business processes;*
- *developing corporate policies for the capture of greenhouse gas emissions;*
- *increasing the use of energy from renewable sources, also through self-production of energy from photovoltaics;*
- *reducing consumption through energy-efficiency improvements, for example through the self-production of electricity with high-efficiency cogeneration and heat recovery in the production cycle;*
- *constant product innovation to propose corporate policies of the circular economy and optimisation of energy consumption and resources for the benefit of the local territory;*
- *implementing corporate and territorial welfare policies for the benefit of its employees;*
- *developing paths of constant attention to industrial production processes, with a particular focus on occupational safety;*
- *identification of the company as an aggregative entity in the territory for stakeholders in the local communities;*
- *promoting a culture of diversity and inclusion within the company and in the territory where it operates.*

These objectives formally reflect our Group's daily commitment to environmental, social and governance (ESG) issues. Following the above-mentioned transformation, the Board of Directors appointed a company Impact Manager, who was formally assigned the responsibility of implementing the monitoring and reporting of social impact objectives following the management's provisions, identifying appropriate methods and criteria for this purpose.

Italcer Group, une Benefit Corporation

En octobre 2023, Italcer SpA, en tant que leader du Groupe, a obtenu le statut de Benefit Company, devenant Italcer Società per Azioni Società Benefit. Cette transformation implique une nouvelle prise de responsabilité de la part du Conseil d'administration et de la direction de Italcer S.p.A. SB envers les personnes, les communautés, les territoires et l'environnement dans lesquels l'entreprise opère, et a demandé l'intégration, dans son statut social, outre les objectifs habituels de profit, des objectifs d'intérêt commun énumérés ci-dessous :

- *la réduction des émissions de gaz à effet de serre dans les processus d'entreprise ;*
- *l'élaboration de politiques d'entreprise visant à capter les émissions de gaz à effet de serre des entreprises ;*
- *l'augmentation de l'utilisation d'énergie provenant de sources renouvelables également à travers l'autoproduction d'énergie photovoltaïque ;*
- *la réduction de la consommation grâce à des mesures d'efficacité énergétique, par exemple grâce à l'autoproduction d'électricité avec cogénération à haut rendement et à la récupération de chaleur dans le cycle de production ;*
- *l'innovation produits constante pouvant donner lieu à des politiques d'entreprise d'économie circulaire et d'optimisation de la consommation d'énergie et des ressources au profit du territoire de référence ;*
- *la mise en œuvre de politiques sociales d'entreprise et locales au profit de ses employés ;*
- *le développement de parcours d'attention constante aux processus de production industrielle, avec un accent particulier sur la sécurité au travail ;*
- *l'identification de l'entreprise comme entité agrégative de référence sur le territoire pour les acteurs des communautés locales de référence ;*
- *la promotion de la culture de la diversité et de l'inclusion au sein de l'Entreprise et dans la zone où elle opère.*

Ces objectifs traduisent formellement l'engagement que notre Groupe prend au quotidien sur les enjeux environnementaux, sociaux et de gouvernance (ESG). Suite à la transformation susmentionnée, un « Responsable d'impact » de la Société a été nommé par le Conseil d'administration. Celui-ci est formellement chargé de mettre en œuvre, dans le respect des dispositions de la direction, le suivi et le reporting des objectifs d'impact social, ainsi que d'identifier les modalités et critères appropriés à cet effet.

Italcer Group, eine Benefit-Gesellschaft

Im Oktober 2023 hat Italcer S.p.A. als Muttergesellschaft des Konzerns die Qualifikation als Benefit-Gesellschaft erworben und sich in Italcer Società per Azioni Società Benefit umbenannt. Diese Umwandlung impliziert eine zusätzliche Übernahme von Verantwortung durch den Verwaltungsrat und die Geschäftsleitung von Italcer S.p.A. SB gegenüber Personen, Gemeinschaften, Gebieten und der Umwelt, in denen das Unternehmen tätig ist, und erfordert die Aufnahme folgender gemeinschaftlicher Ziele in die Satzung, ergänzend zu den üblichen Gewinnzielen:

- *die Reduzierung der Emissionen von Treibhausgasen in den Unternehmensprozessen;*
- *die Entwicklung unternehmerischer Strategien zur Abscheidung von Treibhausgasemissionen des Unternehmens;*
- *die Steigerung des Einsatzes erneuerbarer Energien, auch durch Eigenproduktion von Photovoltaikstrom;*
- *die Senkung des Verbrauchs durch Maßnahmen zur Energieeffizienz, beispielsweise durch Eigenproduktion von Strom mit hocheffizienter Kraft-Wärme-Kopplung und Wärmerückgewinnung im Produktionsprozess;*
- *die kontinuierliche Produktinnovation, um unternehmerische Strategien der Kreislaufwirtschaft und der Optimierung des Energieverbrauchs und der Ressourcen zum Wohle des jeweiligen Gebiets zu fördern;*
- *die Umsetzung unternehmerischer Sozialleistungen und territorialer Maßnahmen zum Wohle der eigenen Mitarbeiter;*
- *die Entwicklung von Prozessen zur kontinuierlichen Aufmerksamkeit für industrielle Produktionsprozesse mit besonderem Schwerpunkt auf Arbeitssicherheit;*
- *die Identifizierung des Unternehmens als Bezugspunkt für Interessengruppen der lokalen Gemeinschaften;*
- *die Förderung einer Kultur der Vielfalt und Inklusion innerhalb des Unternehmens und in seinem Tätigkeitsgebiet.*

Diese Ziele spiegeln formal das Engagement unseres Konzerns wider, das wir täglich für Umwelt-, Sozial- und Governance-Themen (ESG) einsetzen. Im Anschluss an diese Umwandlung hat der Verwaltungsrat einen "Verantwortlichen für die Auswirkungen" des Unternehmens ernannt, dem offiziell die Aufgabe übertragen wurde, im Einklang mit den Anweisungen der Geschäftsleitung die Überwachung und Berichterstattung über die sozialen Auswirkungen zu gewährleisten, indem geeignete Methoden und Kriterien festgelegt werden.

Il contributo di Italcera Group agli obiettivi di sviluppo sostenibile

Italcera Group attraverso le sue quotidiane azioni, piani e procedure specifiche crea valore sostenibile, al fine di generare un **impatto positivo sulla società e sull'ambiente** e contribuire al raggiungimento di alcuni degli **Obiettivi di Sviluppo Sostenibile dell'ONU**. L'Agenda 2030 dell'ONU per lo Sviluppo Sostenibile è un programma d'azione globale finalizzato ad eradicare la povertà, proteggere il pianeta e promuovere la prosperità e la pace, adottato all'unanimità dai 193 Paesi membri delle Nazioni Unite.

Gli Stati aderenti all'ONU si sono impegnati a raggiungere **17 Obiettivi di Sviluppo Sostenibile – Sustainable Development Goals, SDGs** – i quali si articolano a loro volta in 169 target o traguardi specifici, tra loro interconnessi e indivisibili, che costituiscono il nuovo quadro di riferimento per lo sviluppo sostenibile, inteso come uno sviluppo che soddisfa i bisogni del presente senza compromettere la capacità delle future generazioni di soddisfare i propri, armonizzando a tal fine le tre dimensioni della crescita economica, dell'inclusione sociale e della tutela dell'ambiente.

Italcera Group concorre allo sviluppo sostenibile in linea con gli Obiettivi delle Nazioni Unite, contribuendo al raggiungimento di ben 9 dei 17 SDGs, come illustrato di seguito.



Italcera Group's contribution to the Sustainable Development Goals

Through its daily actions, plans and specific procedures, Italcera Group creates sustainable value to generate a **positive impact on society and the environment** and contribute to achieving some of the **UN Sustainable Development Goals**. The UN 2030 Agenda for Sustainable Development is a programme for global action aimed at eradicating poverty, protecting the planet and promoting prosperity and peace. It was adopted unanimously by the 193 member countries of the United Nations.

UN member states are committed to achieving **17 Sustainable Development Goals (SDGs)**, which are in turn organised into 169 specific, interconnected and indivisible targets. These constitute the new reference framework for sustainable development, which is understood as development that meets the needs of the present without compromising the ability of future generations to meet their own. The goals are balanced across three dimensions: economic growth, social inclusion and environmental protection.

Italcera Group contributes to sustainable development in line with the UN SDGs, working to achieve 9 of the 17 goals, as illustrated below.

La contribution du Groupe Italcera aux objectifs du développement durable

Le Groupe Italcera, par ses actions quotidiennes, ses plans et ses procédures spécifiques, crée une valeur durable afin de générer un impact positif sur la société et l'environnement et de contribuer à la réalisation de certains des **Objectifs de développement durable des Nations unies**. L'Agenda 2030 des Nations unies pour le développement durable est un programme d'action mondial visant à éradiquer la pauvreté, à protéger la planète et à promouvoir la prospérité et la paix, adopté à l'unanimité par les 193 États membres des Nations unies.

Les États membres des Nations unies se sont engagés à atteindre **17 objectifs de développement durable (ODD)**, eux-mêmes divisés en 169 cibles ou objectifs spécifiques interconnectés et indivisibles. Ils constituent le nouveau cadre de référence du développement durable, entendu comme un développement qui répond aux besoins du présent sans compromettre la capacité des générations futures à répondre aux leurs, en harmonisant les trois dimensions de la croissance économique, de l'inclusion sociale et de la protection de l'environnement.

Le Groupe Italcera contribue au développement durable conformément aux objectifs des Nations unies en contribuant à la réalisation d'au moins **9 des 17 ODD**, comme illustré ci-dessous.

Engagement der Italcera Group für nachhaltige Entwicklung

Die Italcera Group schafft durch ihre täglichen Aktivitäten, spezifischen Pläne und Verfahren nachhaltigen Wert, um einen **positiven Einfluss auf Gesellschaft und Umwelt zu haben** und zur Erreichung einiger der Ziele für nachhaltige Entwicklung der Vereinten Nationen beizutragen. Die Agenda 2030 der Vereinten Nationen für nachhaltige Entwicklung ist ein globales Aktionsprogramm, das darauf abzielt, Armut zu beseitigen, den Planeten zu schützen und Wohlstand sowie Frieden zu fördern. Sie wurde einstimmig von allen 193 Mitgliedstaaten der Vereinten Nationen verabschiedet.

Die UNO-Mitgliedstaaten haben sich verpflichtet, **17 Ziele für nachhaltige Entwicklung (Sustainable Development Goals, SDGs)** zu erreichen, die sich in 169 spezifischen Zielen oder Unterzielen gliedern. Diese sind miteinander verbunden und untrennbar und bilden den neuen Rahmen für nachhaltige Entwicklung. Diese Entwicklung soll die Bedürfnisse der Gegenwart befriedigen, ohne die Fähigkeit zukünftiger Generationen zu gefährden, ihre eigenen Bedürfnisse zu befriedigen. Dabei werden die drei Dimensionen wirtschaftliches Wachstum, soziale Inklusion und Umweltschutz in Einklang gebracht.

Italcera Group trägt zur nachhaltigen Entwicklung im Einklang mit den Zielen der Vereinten Nationen bei und unterstützt damit gleich **9 der 17 SDGs**, wie im Folgenden dargestellt.

L'impegno di Italcera Group



- Adozione di politiche attive per garantire la parità di genere e la promozione di un ambiente di lavoro inclusivo e volto a valorizzare le diversità e peculiarità dei singoli, al contempo riducendo le disuguaglianze.
- Garanzia di uguaglianza di politiche salariali a parità di competenze e mansioni.



- Implementazione, all'interno del sistema di gestione integrato del Gruppo, di procedure ad hoc volte a prevenire ogni forma di discriminazione nei confronti di tutte le donne.
- Promozione dei valori della diversità e inclusione, tra cui l'uguaglianza di genere.
- Sostegno all'empowerment femminile e conseguente promozione dell'uguaglianza di genere grazie alla formazione manageriale specifica e alla garanzia effettiva di pari opportunità di leadership alle donne.
- Accesso ai meccanismi di reclamo e alle risorse di sostegno al fine di prevenire molestie.



- Ottimizzazione dei processi di gestione delle risorse idriche attraverso il riciclo e il riutilizzo totale dell'acqua adoperata nei processi produttivi.
- Minimizzazione del rilascio di sostanze chimiche e di materiali pericolosi nell'ambiente.
- Progressivo svincolo dello sviluppo delle società del Gruppo dal consumo delle risorse naturali esauribili.



- Progressiva decarbonizzazione dei processi produttivi in favore dell'implementazione di impianti di energia rinnovabile affidabili, sostenibili e moderni nei siti produttivi del Gruppo, in particolare impianti fotovoltaici.
- Transizione verso un'economia circolare che contribuisca a ridurre le emissioni nocive nell'ambiente e tesa all'efficienza energetica.

Italcera Group's commitment

- Development of ADVANCE®, antiviral, antibacterial and anti-pollution technology to reduce sickness and pollution.
- Innovation of ceramic surface production processes based on strict quality standards.

- Implementing ad hoc procedures in the Group's integrated management system to prevent all form of discrimination against all women.
- Promoting diversity and inclusion, including gender equality.
- Supporting female empowerment and consequently promoting gender equality through specific management training and effective guarantees of equal leadership opportunities for women.
- Access to complaint mechanisms and support resources to prevent harassment.

- Optimising water management through recycling and the total reuse of water used in production processes.
- Minimising the release of chemicals and hazardous materials into the environment.
- Progressive decoupling of the development of Group companies from the consumption of exhaustible natural resources.

- Progressively decarbonise production processes to favour the implementation of reliable, sustainable and modern renewable energy plants at the Group's production sites, particularly photovoltaic plants.
- Transition to a circular economy that helps to reduce harmful emissions into the environment and improve energy efficiency.

L'impegno di Italcera Group

- Attenzione all'innovazione e all'aggiornamento tecnologico nei processi produttivi.
- Creazione e promozione di un'occupazione stabile e dignitosa per tutte le donne e gli uomini, anche per i giovani e le persone con disabilità, garantendo la parità di retribuzione per lavoro di pari valore.
- Tutela dei diritti dei lavoratori attraverso ambienti di lavoro sicuri e protetti.
- Offerta di stage professionalizzanti e aderendo alle iniziative di alternanza scuola-lavoro.
- Adozione di una policy che certifichi l'attenzione al lavoro dignitoso anche da parte di fornitori e clienti.



- Creazione di materiali innovativi e tecnologie ad alte prestazioni sostenibili e responsabili.
- Adozione e sviluppo di tecnologie a basso impatto ambientale.
- Efficientamento e ammodernamento degli impianti grazie all'adozione di tecnologie pulite e rispettose dell'ambiente.

- Adozione di politiche attive per garantire la parità di genere e la promozione di un ambiente di lavoro inclusivo e volto a valorizzare le diversità e peculiarità dei singoli, al contempo riducendo le disuguaglianze.
- Garanzia di uguaglianza di politiche salariali a parità di competenze e mansioni.

- Pubblicazione di una Dichiarazione Ambientale 2020 - 2025.
- Utilizzo di materiali riciclati nei processi produttivi in modo tale da garantire l'uso efficiente delle risorse naturali.
- Riduzione dei materiali di scarto e rifiuto attraverso la prevenzione, la riduzione, il riciclo e il riutilizzo.

- Incremento della produzione di energia elettrica da fonte rinnovabile.
- Realizzazione di interventi di efficientamento energetico di tutti i processi produttivi e delle sedi.
- Uso efficiente delle risorse, in particolare di quella idrica.

Italcera Group's commitment

- Attention to innovation and technological updates in production processes.
- Creating and promoting stable and decent employment for all women and men, including young people and people with disabilities, ensuring equal pay for work of equal value.
- Protecting workers' rights through safe and secure working environments.
- Offering professional-level internships and adhering to school-work programmes.
- Adopting a policy that also certifies suppliers' and customers' attention to decent work.

- Creating sustainable and responsible high-performance materials and technologies.
- Adoption and development of environmentally friendly technologies.
- Modernising and making plants efficient by adopting clean and eco-friendly technologies.

- Adopting active policies to ensure gender equality and promote an inclusive working environment that values the diversity and uniqueness of individuals while reducing inequalities.
- Guaranteeing equal wage policies for equal skills and duties.

- Publication of a 2020-2025 Environmental Declaration.
- Use of recycled materials in production processes to ensure the efficient use of natural resources.
- Reducing waste and waste materials through prevention, reduction, recycling and reuse.

- Increased production of electricity from renewable sources.
- Improving the energy efficiency of all production processes and sites.
- Efficient use of resources, particularly water.

Italcer Group premiato al Sustainability Award 2024

Italcer, società benefit hub del design nella ceramica Made in Italy, si è classificata al primo posto per l'ambiente al Sustainability Award 2024, importante riconoscimento giunto alla quarta edizione e riservato alle migliori aziende italiane che si sono contraddistinte nell'affrontare le sfide dell'emergenza climatica, trasformandola in un'occasione per esprimere innovazione ed attivare le energie del Paese.

Oltre 300.000 aziende dell'industria italiana e dei servizi hanno investito in **sostenibilità ed efficienza** – rivolgendo particolare attenzione al settore dell'**efficienza energetica** e nelle fonti **rinnovabili** – segnando un vero record di **eco-investimenti**.

La classifica, stilata da **Kon Group** ed **ELITE**, ecosistema del Gruppo Euronext, che ha avuto come partner scientifico istituzionale il Politecnico di Milano, vede quest'anno Italcer al vertice delle imprese **sostenibili**, tutte dotate di **rating ESG** emesso dal partner scientifico istituzionale **ALTIS Advisory**, spin-off dell'Università Cattolica del Sacro Cuore e da **RepRisk** come partner tecnico.

Più in particolare, **Italcer** si è classificata al primo posto delle **"TOP 100 ENVIRONMENTAL>250"**, ottenendo il punteggio più elevato in campo ambientale tra le imprese candidate con fatturato superiore a 250 milioni di euro.

Graziano Verdi, Amministratore Delegato di **Italcer Group** spiega: "Questo premio sottolinea l'importanza di svolgere progetti di **ricerca e sviluppo** e soprattutto di implementarli a livello industriale per il raggiungimento degli obiettivi di **riduzione della CO2** dell'**agenda 2030**. Il nostro impegno nell'ambito della **sostenibilità** si estende anche alla nostra catena del valore e alle **comunità** in cui operiamo. È un percorso impegnativo, che richiede una visione **strategica** lungimirante, ma al contempo estremamente motivante, perché ci permette di rispondere con **responsabilità** alle sfide del mercato e delle comunità in cui operiamo".

Il **Gruppo Italcer**, da sempre impegnato nella sfida della **decarbonizzazione** del processo produttivo, ha appena avviato in Spagna un forno elettrico, nato da un progetto di **ricerca** della società **Equipe** in collaborazione con l'Università Jaume I di Castellón e la società **Systemfoc** che consentirà di risparmiare 1.500 tonnellate di **CO2** all'anno. Il progetto è stato sviluppato con l'obiettivo di eliminare completamente le **emissioni dirette di CO2** nella fase di cottura, senza compromettere la **sostenibilità tecnico-economica** dei prodotti realizzati. **Italcer** inoltre ha progettato, dopo anni di ricerca, e brevettato (Brevetto N. 102022000017034) un impianto all'avanguardia volto alla **cattura, trasformazione e fissazione della CO2** emessa in atmosfera dai propri impianti produttivi, oltre che al recupero e alla trasformazione in materiali nobili degli altri **inquinanti** presenti, sia organici che inorganici. Nel solo 2023 il gruppo ha investito 5 milioni di euro in progetti **sociali e ambientali**.



Italcer Group wins Sustainability Award 2024

Italcer, a benefit hub company specialized in Made in Italy ceramic design, ranked first in the environment category at the Sustainability Award 2024, an important recognition now in its fourth edition and reserved for the best Italian companies that have distinguished themselves in addressing the challenges of the climate emergency, transforming it into an opportunity to express innovation and activate the country's energies.

More than 300,000 Italian industrial and service companies have invested in sustainability and efficiency - paying particular attention to the sector of energy efficiency and renewable sources - setting a real record of eco-investments.

The ranking, compiled by Kon Group and ELITE, an ecosystem of the Euronext Group, which had the Politecnico di Milano as its institutional scientific partner, sees Italcer at the top of sustainable companies this year, all of which have an ESG rating issued by the institutional scientific partner ALTIS Advisory, a spin-off of the Catholic University of the Sacred Heart, and by RepRisk as a technical partner.

In particular, Italcer ranked first in the "TOP 100 ENVIRONMENTAL>250", obtaining the highest score in the environmental field among companies with a turnover of over 250 million euros.

Graziano Verdi, CEO of Italcer Group explains: "This award underlines the importance of carrying out research and development projects and above all of implementing them at an industrial level to achieve the CO2 reduction targets of the 2030 agenda. Our commitment to sustainability also extends to our value chain and the communities in which we operate. It is a challenging journey that requires a far-sighted strategic vision, but at the same time it is extremely motivating, because it allows us to respond responsibly to the challenges of the market and the communities in which we operate".

The Italcer Group, which has always been committed to the challenge of decarbonizing the production process, has just started up an electric kiln in Spain, born from a research project by the Equipe company in collaboration with the Jaume I University of Castellón and the Systemfoc company, which will allow it to save 1,500 tons of CO2 per year. The project was developed with the aim of completely eliminating direct CO2 emissions in the firing phase, without compromising the technical-economic sustainability of the products produced. Italcer has also designed, after years of research, and patented (Patent No. 102022000017034) a state-of-the-art plant for the capture, transformation and fixation of CO2 emitted into the atmosphere by its production plants, as well as the recovery and transformation into noble materials of other pollutants present, both organic and inorganic. In 2023 alone, the group invested 5 million euros in social and environmental projects.

Italcer Group récompensé aux Sustainability Awards 2024

Italcer, une société benefit hub spécialisée dans le design de la céramique Made in Italy, s'est classée première en matière d'environnement au Sustainability Award 2024, une importante reconnaissance à sa quatrième édition et réservée aux meilleures entreprises italiennes qui se sont distinguées en relevant les défis de l'urgence climatique, la transformant en une opportunité d'exprimer l'innovation et d'activer les énergies du pays.

Plus de 300 000 entreprises industrielles et de services italiennes ont investi dans la durabilité et l'efficacité - en accordant une attention particulière au secteur de l'efficacité énergétique et aux sources renouvelables - établissant un véritable record d'eco-investissements.

Le classement, établi par Kon Group et ELITE, un écosystème du groupe Euronext, qui avait le Politecnico di Milano comme partenaire scientifique institutionnel, voit Italcer au sommet des entreprises durables cette année, toutes dotées d'une notation ESG émise par le partenaire scientifique institutionnel ALTIS Advisory, une spin-off de l'Université catholique du Sacré-Cœur, et par RepRisk en tant que partenaire technique.

Plus précisément, Italcer s'est classée première des "TOP 100 ENVIRONMENTAL>250", obtenant le score le plus élevé dans le domaine environnemental parmi les entreprises candidates avec un chiffre d'affaires supérieur à 250 millions d'euros.

Graziano Verdi, PDG d'Italcer Group explique : « Ce prix souligne l'importance de mener des projets de recherche et développement et surtout de les mettre en œuvre à l'échelle industrielle pour atteindre les objectifs de réduction du CO2 de l'agenda 2030. Notre engagement en faveur de la durabilité s'étend également à notre chaîne de valeur et aux communautés dans lesquelles nous opérons. C'est un parcours exigeant qui nécessite une vision stratégique clairvoyante, mais qui est en même temps extrêmement motivant, car il nous permet de répondre de manière responsable aux défis du marché et des communautés dans lesquelles nous opérons ».

Le groupe Italcer, engagé depuis toujours dans le défi de la décarbonation du processus de production, vient de mettre en service un four électrique en Espagne, né d'un projet de recherche de la société Equipe en collaboration avec l'Université Jaume I de Castellón et la société Systemfoc qui lui permettra d'économiser 1 500 tonnes de CO2 par an. Le projet a été développé dans le but d'éliminer complètement les émissions directes de CO2 lors de la phase de cuisson, sans compromettre la durabilité technico-économique des produits fabriqués. Italcer a également conçu, après des années de recherche, et breveté (Brevet n° 102022000017034) une installation de pointe visant à la capture, à la transformation et à la fixation du CO2 émis dans l'atmosphère par ses usines de production, ainsi qu'au récupération et transformation en matériaux nobles des autres polluants présents, qu'ils soient organiques ou inorganiques. En 2023 seul, le groupe a investi 5 millions d'euros dans des projets sociaux et environnementaux.

Italcer Group gewinnt den Sustainability Award 2024

Italcer, ein Benefit-Hub-Unternehmen, das auf das Design von Keramik Made in Italy spezialisiert ist, hat bekannt gegeben, dass es beim Sustainability Award 2024 den ersten Platz in der Kategorie Umwelt belegt hat, einer wichtigen Auszeichnung, die bereits zum vierten Mal verliehen wird und den besten italienischen Unternehmen vorbehalten ist, die sich durch die Bewältigung der Herausforderungen des Klimawandels ausgezeichnet haben und sie in eine Gelegenheit verwandelt haben, Innovation auszudrücken und die Energien des Landes zu aktivieren.

Mehr als 300.000 italienische Industrie- und Dienstleistungsunternehmen haben in Nachhaltigkeit und Effizienz investiert – mit besonderem Augenmerk auf den Bereich der Energieeffizienz und der erneuerbaren Energien – und damit einen wahren Rekord bei Öko-Investitionen aufgestellt.

Das Ranking, das von der Kon Group und ELITE, einem Ökosystem der Euronext-Gruppe, erstellt wurde, das das Politecnico di Milano als institutionellen wissenschaftlichen Partner hatte, sieht Italcer in diesem Jahr an der Spitze der nachhaltigen Unternehmen, die alle über ein ESG-Rating verfügen, das vom institutionellen wissenschaftlichen Partner ALTIS Advisory, einem Spin-off der Katholischen Universität des Heiligen Herzens, und von RepRisk als technischem Partner ausgestellt wurde.

Insbesondere belegte Italcer den ersten Platz in der Kategorie "TOP 100 ENVIRONMENTAL>250" und erzielte die höchste Punktzahl im Umweltbereich unter den Unternehmen mit einem Umsatz von über 250 Millionen Euro.

Graziano Verdi, CEO der Italcer Group, erklärt: „Dieser Preis unterstreicht die Bedeutung der Durchführung von Forschungs- und Entwicklungsprojekten und vor allem ihrer Umsetzung auf industrieller Ebene, um die Ziele der CO2-Reduzierung der Agenda 2030 zu erreichen. Unser Engagement für Nachhaltigkeit erstreckt sich auch auf unsere Wertschöpfungskette und die Gemeinschaften, in denen wir tätig sind. Es ist ein anspruchsvoller Weg, der eine weitsichtige strategische Vision erfordert, aber gleichzeitig äußerst motivierend ist, da er es uns ermöglicht, verantwortungsbewusst auf die Herausforderungen des Marktes und der Gemeinschaften zu reagieren, in denen wir tätig sind.“

Die Italcer Group, die sich seit jeher der Herausforderung der Dekarbonisierung des Produktionsprozesses verschrieben hat, hat in Spanien gerade einen Elektroofen in Betrieb genommen, der aus einem Forschungsprojekt der Firma Equipe in Zusammenarbeit mit der Universität Jaume I de Castellón und der Firma Systemfoc entstanden ist und durch den 1.500 Tonnen CO2 pro Jahr eingespart werden können. Das Projekt wurde mit dem Ziel entwickelt, die direkten CO2-Emissionen in der Brennphase vollständig zu eliminieren, ohne die technisch-wirtschaftliche Nachhaltigkeit der hergestellten Produkte zu beeinträchtigen. Italcer hat außerdem nach jahrelanger Forschung ein hochmodernes System zur Abscheidung, Umwandlung und Fixierung von CO2 entwickelt und patentiert (Patent Nr. 102022000017034), das von seinen Produktionsanlagen in die Atmosphäre abgegeben wird, sowie zur Rückgewinnung und Umwandlung anderer vorhandener Schadstoffe in edle Materialien, sowohl organischer als auch anorganischer Natur. Allein im Jahr 2023 hat der Konzern 5 Millionen Euro in soziale und umweltbezogene Projekte investiert.

Marmo e pietra

| | |
|-------------------------------|-----|
| Statuario | 39 |
| Statuario Reale | 47 |
| Breccia Capraia NEW | 55 |
| Calacatta Oro | 63 |
| Bianco Imperiale NEW | 71 |
| Macchia Antica | 79 |
| Avorio Segesta NEW | 87 |
| Travertino Classic | 95 |
| Aesthetica Hegel | 103 |
| Aesthetica Wilde | 111 |
| Green Sky NEW | 119 |
| Onice Iride | 127 |
| Nautilus | 135 |
| Breccia Argentum | 141 |
| Breccia Sicilia NEW | 149 |
| Bronze Amani | 157 |
| Sahara Noir | 165 |
| Black Gold NEW | 171 |
| Deep Stone NEW | 179 |
| Noble Stone | 187 |
| Bolgheri Stone | 197 |
| Gemstone | 205 |
| Imperial | 215 |
| Velaris NEW | 223 |
| Pierres des Châteaux | 235 |
| Pierres des Châteaux Advance® | 235 |
| Royal Stone | 243 |
| Chianca | 249 |
| Ardesia | 259 |
| Storm | 267 |
| Dolomiti | 275 |
| Blue Evolution | 283 |
| I Quarzi | 289 |
| Borghi Italiani | 297 |



Statuario

MARMO E PIETRA

Gres Porcellanato. Porcelain tiles
Grès cérame. Feinsteinzeug
ISO 13006 - G - Bla_E ≤ 0,5%
UNI EN 14411

ANSI A - 326.3: 2021
W E T - D Y N A M I C
COEFFICIENT OF FRICTION

DCOF ≥ 0,42 | naturale

6 mm



160x320
63"x126"
Nat Ret
Lap Ret



120x280
48"x110"
Nat Ret
Lap Ret



120x120
48"x48"
Nat Ret
Lap Ret

Decoro / Decor



Mosaico 30x30
12"x12"
Nat Ret
Lap Ret



Slab A
160x320
63"x126"
Lap Ret



Slab B
160x320
63"x126"
Lap Ret

8,8 mm



60x120
24"x48"
Nat Ret
Lap Ret



60x60
24"x24"
Nat Ret
Lap Ret

— modular system —

Statuario

MARMO E PIETRA

100% DESIGN AND PRODUCTION OF ITALY

Sviluppo grafico per formato
Pattern by size
Développement graphique par format
Grafischer Entwurf für Format

160x320
6 mm
7

160x320
6 mm
2
SlabA/B

120x280
6 mm
11

120x120
6 mm
22

60x120
8,8 mm
30

60x60
8,8 mm
30

Sviluppo Grafico

Pattern by size. Développement graphique par format.
Grafischer Entwurf für Format.

160x320 6 mm



7 PATTERNS

Macchia Aperta

Book match. Taches ouvertes. Offen Flecken.

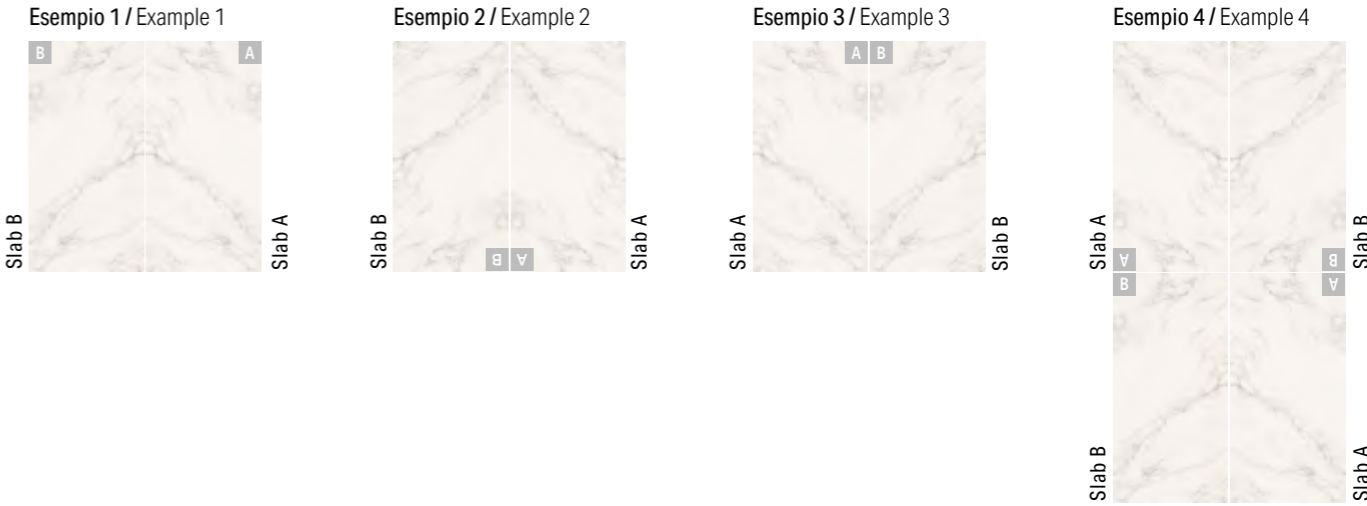

Statuario

6 mm

| 160x320 63"x126" | | 120x280 48"x110" | | 120x120 48"x48" | | Mosaico 30x30 12"x12" | |
|----------------------|---------|---------------------|---------|--------------------|---------|--------------------------|---------|
| Nat Ret | Lap Ret | Nat Ret | Lap Ret | Nat Ret | Lap Ret | Nat Ret | Lap Ret |
| 083004 | 083003 | 083017 | 083027 | 083034 | 083033 | 083194 | 083193 |
| Price code M173 M197 | | M153 M175 | | M141 M169 | | M193 M235 | |

6 mm

| Slab A/B | |
|----------------------|--|
| 160x320 63"x126" | |
| Lap Ret | |
| 083091 A 083092 B | |
| Price code M197 | |

8,8 mm

| 60x120 24"x48" | | 60x60 24"x24" | |
|----------------------|---------|------------------|---------|
| Nat Ret | Lap Ret | Nat Ret | Lap Ret |
| 083064 | 083063 | 083084 | 083083 |
| Price code M109 M125 | | M089 M113 | |

Pezzi Speciali / Trims. Pièces speciale. Die Sonderstücke

6 mm

| Gradino costa retta** Straight-edge stair** | | Gradino costa retta SX - DX** Straight-edge step L-R corner** | |
|--|---------|--|------------------------|
| 33x120 | | 33x120 | |
| Nat Ret | Lap Ret | Nat Ret | Lap Ret |
| 083262 | 083263 | 083342 SX 083302 DX | 083343 SX 083303 DX |
| Price code P243 P265 | | P273 P283 | |

8,8 mm

| Battiscopa Skirting | | Gradino costa retta** Straight-edge stair** | | Gradino costa retta SX - DX** Straight-edge step L-R corner** | |
|------------------------|---------|--|---------|--|------------------------|
| 6,5x120 | | 33x120 | | 33x120 | |
| Nat Ret | Lap Ret | Nat Ret | Lap Ret | Nat Ret | Lap Ret |
| 083214 | 083213 | 083284 | 083283 | 083362 SX 083322 DX | 083363 SX 083323 DX |
| Price code P040 P043 | | P207 P215 | | P231 P243 | |

Calpestio (per la finitura naturale) . Foot traffic (for natural finish)

• STATUARIO HIGH



Backsplash / Counter top / Furniture
Statuario Lap

Imballi / Packings. Emballage. Verpackung

| | PCS/BOX | MQ/BOX | KG/BOX | PCS/PAL | BOX/PAL | MQ/PAL | KG/PAL | PACKING | PACKING SIZE | TARE (KG) |
|----------------------|---------|--------|--------|---------|---------|--------|--------|-----------------|-----------------|-----------|
| 6 mm | | | | | | | | | | |
| 160 x 320 + SLAB A/B | - | - | - | 14 | - | 71,68 | 1.038 | CASSA | 345 x 175 x 37h | 140 |
| 120 x 280 | - | - | - | 20 | - | 67,20 | 973 | CASSA | 292 x 145 x 35h | 108 |
| 120 x 120 | 2 | 2,88 | 41,7 | - | 24 | 69,12 | 1.002 | PALLET SPECIALE | 123 x 143 x 74h | 29 |
| MOSAICO 30 x 30 | 9 | 0,81 | 11,9 | - | 60 | 48,60 | 720 | EPAL | 80 x 120 | 22 |
| 8,8 mm | | | | | | | | | | |
| 60 x 120 Nat | 2 | 1,44 | 27,2 | - | 32 | 46,08 | 869 | EPAL | 80 x 120 | 22 |
| 60 x 120 Lap | 2 | 1,44 | 27,9 | - | 30 | 43,20 | 837 | EPAL | 80 x 120 | 22 |
| 60 x 60 | 3 | 1,08 | 20,3 | - | 40 | 43,20 | 812 | EPAL | 80 x 120 | 22 |



Cavalletto in legno
Wood A-Frame. Support en bois.
Holzgestell



Cassa
Crate . Caisse . Kiste



Pallet speciale con sponde
Special pallet with sides.
Palette spéciale avec bords.
Spezial-Palette mit Wandungen.



Epal/Pallet

| Pezzi Speciali / Trims | PCS/BOX | MQ/BOX | KG/BOX | PACKING | PACKING SIZE |
|---|---------|--------|--------|---------|--------------|
| 6 mm | | | | | |
| GRADINO COSTA RETTA 33 x 120 x 3,2h | 2 | - | 12 | PALLET | 80 x 120 |
| GRADINO COSTA RETTA 33 x 120 x 3,2h SX/DX | 1 | - | 6 | PALLET | 80 x 120 |
| 8,8 mm | | | | | |
| BATTISCOPA 6,5x120 | 6 | - | 11,4 | PALLET | 80 x 120 |
| GRADINO COSTA RETTA 33 x 120 x 3,2h | 2 | - | 22 | PALLET | 80 x 120 |
| GRADINO COSTA RETTA 33 x 120 x 3,2h SX/DX | 1 | - | 11 | PALLET | 80 x 120 |

** A disposizione solo su richiesta. Tempi di consegna: 30gg
Available upon request only. Delivery terms: 30 days
Disponible seulement sur requête. Délais de livraison: 30 jours
Verfügbar auf Anfrage. Lieferzeit: 30 Tage



Statuario Reale

MARMO E PIETRA

6 mm



160x320
63"x126"
Nat Ret
Lap Ret



120x280
48"x110"
Nat Ret
Lap Ret



120x120
48"x48"
Lap Ret

8,8 mm



60x120
24"x48"
Nat Ret **R10A**
Lap Ret

Statuario Reale

MARMO E PIETRA

100% DESIGN AND PRODUCTION OF ITALY

Sviluppo grafico per formato
Pattern by size
Développement graphique par format
Grafischer Entwurf für Format

160x320
6 mm
6

120x280
6 mm
6

120x120
6 mm
12

60x120
8,8 mm
30

Sviluppo Grafico

Pattern by size. Développement graphique par format. Grafischer Entwurf für Format

160x320 6 mm



6 PATTERNS

Composizione a vena continua

Continuous vein effect. Composition à nervures continues. Durchgehender marmorierung

COMPOSIZIONE DI 6 LASTRE A VENA CONTINUA FORMATO 160x320 SP 6 MM_63"x126" THK 6 MM
DISPONIBILE CON FINITURA NATURALE RETTIFICATA OPPURE LAPPATA RETTIFICATA



Composition with 6 continuous vein tiles size 160x320 thk 6 mm_63"x126" thk 6 mm available with natural rectified or lapped rectified finish.
Composition de 6 plaques à veines continues format 160x320 ép. 6 Mm disponible avec finition naturelle rectifiée ou rodée rectifiée.
Zusammenstellung aus 6 st. Platten mit durchgehender marmorierung, format 160x320, st. 6 Mm_126"x63" thk 6 mm verfügbar mit finish natur geschliffen oder geläpft geschliffen.

COMPOSIZIONE DI 6 LASTRE A VENA CONTINUA FORMATO 120x280 SP 6 MM_48"x110" THK 6 MM
DISPONIBILE CON FINITURA NATURALE RETTIFICATA OPPURE LAPPATA RETTIFICATA

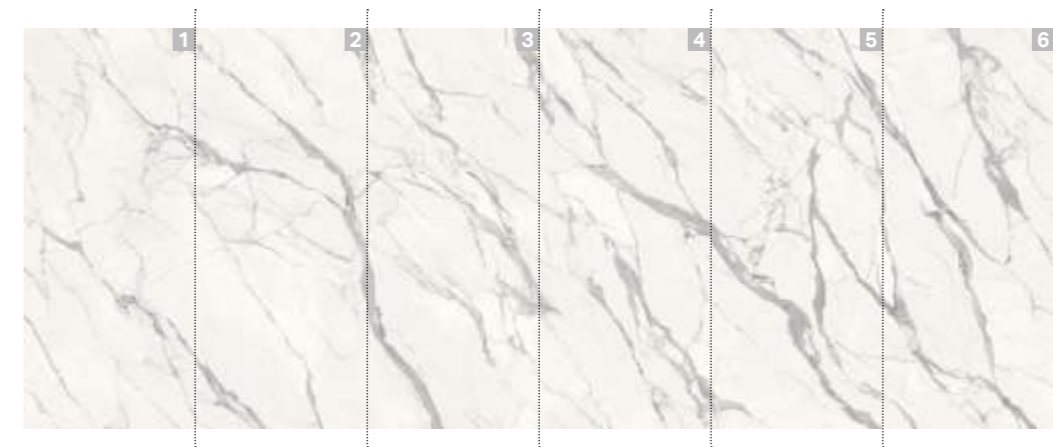

Composition with 6 continuous vein tiles size 120x280 sp 6 mm_48"x110" thk 6 mm available with natural rectified or lapped rectified finish.
Composition de 6 plaques à veines continues format 120x280 ép. 6 Mm disponible avec finition naturelle rectifiée ou rodée rectifiée.
Zusammenstellung aus 6 st. Platten mit durchgehender marmorierung, format 120x280, st. 6 Mm_48"x110" thk 6 mm verfügbar mit finish natur geschliffen oder geläpft geschliffen.

Le lastre sono fornite con le grafiche random. Possono essere fornite con **composizione a vena continua** con una maggiorazione nel prezzo e solo su richiesta esplicita del cliente.

The tiles are supplied with random graphics. They may be supplied with continuous vein effect at an additional charge and only if specifically requested by the customer.

Les plaques sont fournies avec graphiques aléatoires. Elles sont disponibles dans la composition à nervures continues avec une majoration sur le prix et seulement sur demande explicite du client.

Die platten werden mit zufälliger marmorierung geliefert. Sie können auf ausdrücklichen wunsch des kunden gegen aufpreis auch mit einer durchgehenden marmorierung geliefert werden.

Il disegno riprodotto è indicativo. La **grafica di chain** può mostrare discontinuità di vena nel passaggio da una lastra all'altra. Per questo motivo **differenze fino a 3 cm** devono essere considerate come caratteristica del prodotto.

The drawing is purely illustrative. The graphic design of chain may result in discontinuities in the veining between panels. Discontinuities of up to 3 cm are not defects, but are characteristic of the product.

Le dessin reproduit est indicatif. De même que le matériau naturel, le graphisme de chain peut présenter des marbrures discontinues d'une dalle à l'autre. Pour cette raison, les différences jusqu'à 3 cm doivent être considérées comme une caractéristique du produit.

Die wiedergegebene zeichnung ist eine musterzeichnung. Wie für das natürliche material kann auch die grafik von chain brüche der aderungen beim übergang von einer platte zur andern aufweisen. Aus diesem grund sind unterschiede bis zu 3 cm als charakteristik des produkts zu betrachten.

Statuario Reale

| 6 mm | | 120x280 | | 120x120 | | 8,8 mm | |
|------------|---------------------|---------|---------------------|---------|--------------------|---------------------|-------------------|
| | 160x320 63"x126" | | 120x280 48"x110" | | 120x120 48"x48" | | 60x120 24"x48" |
| | Nat Ret | Lap Ret | Nat Ret | Lap Ret | Lap Ret | Nat Ret R10A | Lap Ret |
| | 163008 | 163007 | 163018 | 163017 | 163027 | 163108 | 163107 |
| Price code | M173 | M197 | M153 | M175 | M169 | M109 | M125 |

Pezzi Speciali / Trims. Pièces speciale. Die Sonderstücke

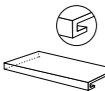
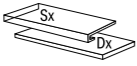
| 6 mm | | 8,8 mm | |
|--|---|--|---|
|  | Gradino costa retta** Straight-edge stair** |  | Gradino costa retta SX - DX** Straight-edge step L-R corner** |
| | 33x120 | | 33x120 |
| | Lap Ret | | Lap Ret |
| | 163352 | | 163353 SX 163354 DX |
| Price code | P265 | | P283 |

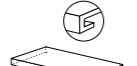
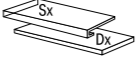
| 8,8 mm | | 8,8 mm | | 8,8 mm | | |
|---|-------------------------------|---|---|---|---|------------------------|
|  | Battiscopa Skirting |  | Gradino costa retta** Straight-edge stair** |  | Gradino costa retta SX - DX** Straight-edge step L-R corner** | |
| | 6,5x120 | | 33x120 | | 33x120 | |
| | Nat Ret R10A | Lap Ret | Nat Ret R10A | Lap Ret | Nat Ret R10A | Lap Ret |
| | 163214 | 163213 | 163346 | 163361 | 163365 SX 163368 DX | 163362 SX 163363 DX |
| Price code | P040 | P043 | P207 | P215 | P231 | P243 |

Calpestio (per la finitura naturale) . Foot traffic (for natural finish)

• STATUARIO REALE  HIGH



Wall
Statuario Reale 160x320_63"x126" Lap Ret

Imballi / Packings. Emballage. Verpackung

| | PCS/BOX | MQ/BOX | KG/BOX | PCS/PAL | BOX/PAL | MQ/PAL | KG/PAL | PACKING | PACKING SIZE | TARE (KG) |
|---------------|---------|--------|--------|---------|---------|--------|--------|------------------|-------------------|-----------|
| 6 mm | | | | | | | | | | |
| 160 x 320 | - | - | - | 14 | - | 76,80 | 985 | CASSA | 345 x 175 x 37h | 140 |
| | - | - | - | 44 | - | 225,28 | 3.263 | CAVALLETTO LEGNO | 330 x 75 x 193,5h | 177,50 |
| 120 x 280 | - | - | - | 20 | - | 67,20 | 974 | CASSA | 292 x 145 x 35h | 108 |
| | - | - | - | 44 | - | 147,84 | 2.205 | CAVALLETTO LEGNO | 290 x 75 x 161h | 145 |
| 120 x 120 | 2 | 2,88 | 42,5 | - | 24 | 69,12 | 1.020 | PALLET SPECIALE | 123 x 143 x 74h | 29 |
| 8,8 mm | | | | | | | | | | |
| 60 x 120 Nat | 2 | 1,44 | 26,8 | - | 32 | 46,08 | 857 | EPAL | 80 x 120 | 22 |
| 60 x 120 Lap | 2 | 1,44 | 32,5 | - | 30 | 43,20 | 976 | EPAL | 80 x 120 | 22 |



Cavalletto in legno
Wood A-Frame. Support en bois.
Holzgestell



Cassa
Crate . Caisse . Kiste



Pallet speciale con sponde
Special pallet with sides .
Palette spéciale avec bords.
Spezial-Palette mit Wandungen.



Epal/Pallet

| Pezzi Speciali / Trims | PCS/BOX | MQ/BOX | KG/BOX | PACKING | PACKING SIZE |
|--|---------|--------|--------|-----------------|------------------|
| 6 mm | | | | | |
| GRADINO COSTA RETTA 33 x 160 x 3,2h ** | 1 | - | 9 | PALLET SPECIALE | 168 x 97 x 40,9h |
| GRADINO COSTA RETTA 33 x 160 x 3,2h SX/DX ** | 1 | - | 10 | PALLET SPECIALE | 168 x 97 x 40,9h |
| GRADINO COSTA RETTA 33 x 120 x 3,2h ** | 2 | - | 14 | PALLET | 80 x 120 |
| GRADINO COSTA RETTA 33 x 120 x 3,2h SX/DX ** | 1 | - | 7 | PALLET | 80 x 120 |
| 8,8 mm | | | | | |
| BATTISCOPA 6,5 x 120 | 6 | - | 11,4 | PALLET | 80 x 120 |
| GRADINO COSTA RETTA 33 x 120 x 3,2h ** | 2 | - | 20,7 | PALLET | 80 x 120 |
| GRADINO COSTA RETTA 33 x 120 x 3,2h SX/DX ** | 1 | - | 10,8 | PALLET | 80 x 120 |

** A disposizione solo su richiesta. Tempi di consegna: 30gg
Available upon request only. Delivery terms: 30 days
Disponible seulement sur requête. Délais de livraison: 30 jours
Verfügbar auf Anfrage. Lieferzeit: 30 Tage



*Breccia
Capraia*

MARMO E PIETRA



Gres Porcellanato. Porcelain tiles
Grès cérame. Feinsteinzeug
ISO 13006 - G - Bla_E ≤ 0,5%
UNI EN 14411

ANSI A - 326.3: 2021
W E T D Y N A M I C
COEFFICIENT OF FRICTION

DCOF ≥ 0,42 | naturale

6 mm



120x280
48"x110"
* Nat Ret
Lap Ret

8,8 mm



60x120
24"x48"
* Nat Ret **R10A**
Lap Ret

* **Materic Touch per la superficie naturale**
Materic Touch for Natural surface
Toucher Matériel pour la surface naturelle
Materische Haptik für die natürliche Oberfläche

La struttura e il tono tra i fondi di spessore 6mm e 8,8mm potrebbero presentare differenze.
The structure and shade of the tiles with 6 mm and 8.8 mm thickness could show differences.
La structure et la teinte des carreaux de 6 mm et 8,8 mm d'épaisseur peuvent présenter des différences.
Die Struktur und der Farbton der Fliesen mit einer Dicke von 6 mm und 8,8 mm könnten Unterschiede aufweisen.

Breccia Capraia

MARMO E PIETRA

NEW SERIES

100% DESIGN AND PRODUCTION OF ITALY

Sviluppo grafico per formato
Pattern by size
Développement graphique par format
Grafischer Entwurf für Format

120x280
6 mm
4

60x120
8,8 mm
14

Sviluppo Grafico

Pattern by size. Développement graphique par format.
Grafischer Entwurf für Format.

120x280 6 mm



4 PATTERNS

60x120 8,8 mm



Lo sviluppo grafico mostra solo una selezione dei pattern disponibili. Il numero totale delle grafiche è indicato di seguito.

The graphic development shows only a selection of the available patterns. The total number of patterns is specified below.

Le développement graphique montre uniquement une sélection des motifs disponibles. Le nombre total de motifs est indiqué ci-dessous.

Die grafische Entwicklung zeigt nur eine Auswahl der verfügbaren Muster. Die Gesamtzahl der Muster ist unten angegeben.

14 PATTERNS

Breccia Capraia

6 mm

120x280
48"x110"

| | * Nat Ret | Lap Ret |
|---|-----------|---------|
|  | 274001 | 274002 |
| Price code | M153 | M175 |

8,8 mm

60x120
24"x48"

| | * Nat Ret R10A | Lap Ret |
|---|----------------|---------|
|  | 274101 | 274102 |
| Price code | M109 | M125 |



* **Materic Touch per la superficie naturale**
Materic Touch for Natural surface
Toucher Matériel pour la surface naturelle
Materische Haptik für die natürliche Oberfläche

La struttura e il tono tra i fondi di spessore 6mm e 8,8mm potrebbero presentare differenze.

The structure and shade of the tiles with 6 mm and 8.8 mm thickness could show differences.

La structure et la teinte des carreaux de 6 mm et 8,8 mm d'épaisseur peuvent présenter des différences.

Die Struktur und der Farbton der Fliesen mit einer Dicke von 6 mm und 8,8 mm könnten Unterschiede aufweisen.

Pezzi Speciali / Trims. Pièces speciale. Die Sonderstücke

8,8 mm

| | Battiscopa Skirting 6,5x120 | | Gradino costa retta** Straight-edge stair** 33x120 | | Gradino costa retta SX - DX** Straight-edge step L-R corner** 33x120 | |
|---|-----------------------------------|---------|--|---------|--|------------------------|
| | Nat Ret R10A | Lap Ret | Nat Ret R10A | Lap Ret | Nat Ret R10A | Lap Ret |
|  | 274501 | 274502 | 274601 | 274602 | 274621 SX 274611 DX | 274622 SX 274612 DX |
| Price code | P040 | P043 | P207 | P215 | P231 | P243 |

Calpestio (per la finitura naturale) . Foot traffic (for natural finish)

• BRECCIA CAPRAIA  HIGH



Wall
Breccia Capraia 120x280_48"x110" Lap Ret

Imballi / Packings. Emballage. Verpackung

| | PCS/BOX | MQ/BOX | KG/BOX | PCS/PAL | BOX/PAL | MQ/PAL | KG/PAL | PACKING | PACKING SIZE | TARE (KG) |
|------------------|---------|--------|--------|---------|---------|--------|--------|------------------|-----------------|-----------|
| 6 mm | | | | | | | | | | |
| 120 x 280 | - | - | - | 20 | - | 67,20 | 974 | CASSA | 292 x 145 x 35h | 108 |
| | - | - | - | 44 | - | 147,84 | 2.285 | CAVALLETTO LEGNO | 290 x 75 x 161h | 145 |
| 8,8 mm | | | | | | | | | | |
| 60 x 120 Nat Ret | 2 | 1,44 | 27,8 | - | 32 | 46,08 | 889 | EPAL | 80 x 120 x 75h | 22 |
| 60 x 120 Lap Ret | 2 | 1,44 | 27,8 | - | 30 | 43,20 | 834 | EPAL | 80 x 120 x 75h | 22 |



Cavalletto in legno
Wood A-Frame. Support en bois.
Holzgestell



Cassa
Crate . Caisse . Kiste



Epal/Pallet

| Pezzi Speciali / Trims | PCS/BOX | MQ/BOX | KG/BOX | PACKING | PACKING SIZE |
|---|---------|--------|--------|---------|--------------|
| 8,8 mm | | | | | |
| BATTISCOPA 6,5 x 120 | 6 | - | 11,4 | PALLET | 80 x 120 |
| GRADINO COSTA RETTA 33 x 120 x 3,2h ** | 2 | - | 20,7 | PALLET | 80 x 120 |
| GRADINO COSTA RETTA 33 x 120 x 3,2h SX/DX** | 1 | - | 10,8 | PALLET | 80 x 120 |

** A disposizione solo su richiesta. Tempi di consegna: 30gg
Available upon request only. Delivery terms: 30 days
Disponible seulement sur requête. Délais de livraison: 30 jours
Verfügbar auf Anfrage. Lieferzeit: 30 Tage

Calacatta Oro

MARMO E PIETRA





Gres Porcellanato. Porcelain tiles
Grès cérame. Feinsteinzeug
ISO 13006 - G - Bla_E ≤ 0,5%
UNI EN 14411

ANSI A - 326.3: 2021
W E T - D Y N A M I C
COEFFICIENT OF FRICTION

DCOF ≥ 0,42 | naturale

6 mm



160x320
63"x126"
Nat Ret
Lap Ret



120x280
48"x110"
Nat Ret
Lap Ret



120x120
48"x48"
Lap Ret

8,8 mm



60x120
24"x48"
Nat Ret **R10A**
Lap Ret

Calacatta Oro

MARMO E PIETRA

100% DESIGN AND PRODUCTION OF ITALY

Sviluppo grafico per formato
Pattern by size
Développement graphique par format
Grafischer Entwurf für Format

160x320
6 mm
4

120x280
6 mm
4

120x120
6 mm
8

60x120
8,8 mm
21

Sviluppo Grafico

Pattern by size. Développement graphique par format. Grafischer Entwurf für Format.

160x320 6 mm



PATTERNS 4



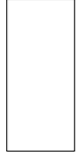

Wall & Floor
Calacatta Oro 160x320_63"x126" Lap Ret

Calacatta Oro

6 mm



| | | |
|---|---|---|
|  |  |  |
| 160x320 63"x126" | 120x280 48"x110" | 120x120 48"x48" |
| Nat Ret | Lap Ret | Nat Ret |
| Lap Ret | Nat Ret | Lap Ret |
| Lap Ret | Lap Ret | Lap Ret |
|  | 163006 | 163005 |
| | 163016 | 163015 |
| Price code | M173 | M197 |
| | M153 | M175 |
| | | M169 |

8,8 mm

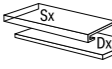

| |
|---|
|  |
| 60x120 24"x48" |
| Nat Ret [R10A] |
| Lap Ret |
|  |
| 163106 |
| 163105 |
| Price code |
| M109 |
| M125 |

Pezzi Speciali / Trims. Pièces speciale. Die Sonderstücke

6 mm

| | |
|---|---|
|  |  |
| Gradino costa retta** Straight-edge stair** | Gradino costa retta SX - DX** Straight-edge step L-R corner** |
| 33x120 | 33x120 |
| Lap Ret | Lap Ret |
|  | 163334 |
| | 163335 SX |
| | 163336 DX |
| Price code | P265 |
| | P283 |

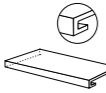
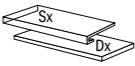
8,8 mm

| | | |
|---|---|---|
|  |  |  |
| Battiscopa Skirting | Gradino costa retta** Straight-edge stair** | Gradino costa retta SX - DX** Straight-edge step L-R corner** |
| 6,5x120 | 33x120 | 33x120 |
| Nat Ret [R10A] | Lap Ret | Nat Ret [R10A] |
| Lap Ret | Nat Ret [R10A] | Lap Ret |
| Lap Ret | Lap Ret | Lap Ret |
|  | 163210 | 163209 |
| | 163369 | 163343 |
| | 163348 SX | 163348 SX |
| | 163367DX | 163345 DX |
| Price code | P040 | P043 |
| | P207 | P215 |
| | P231 | P243 |

Calpestio (per la finitura naturale) . Foot traffic (for natural finish)

• CALACATTA ORO  HIGH



Wall
Calacatta Oro 160x320_63"x126" Lap Ret

Imballi / Packings. Emballage. Verpackung

| | PCS/BOX | MQ/BOX | KG/BOX | PCS/PAL | BOX/PAL | MQ/PAL | KG/PAL | PACKING | PACKING SIZE | TARE (KG) |
|---------------|---------|--------|--------|---------|---------|--------|--------|------------------|-------------------|-----------|
| 6 mm | | | | | | | | | | |
| 160 x 320 | - | - | - | 14 | - | 71,68 | 1.039 | CASSA | 345 x 175 x 37h | 140 |
| | - | - | - | 44 | - | 225,28 | 3.262 | CAVALLETTO LEGNO | 330 x 75 x 193,5h | 210 |
| 120 x 280 | - | - | - | 20 | - | 67,20 | 974 | CASSA | 292 x 145 x 35h | 108 |
| | - | - | - | 44 | - | 147,84 | 2.140 | CAVALLETTO LEGNO | 290 x 75 x 161h | 145 |
| 120 x 120 | 2 | 2,88 | 42,5 | - | 24 | 69,12 | 1.020 | PALLET SPECIALE | 123 x 143 x 74h | 29 |
| 8,8 mm | | | | | | | | | | |
| 60 x 120 Nat | 2 | 1,44 | 26,7 | - | 32 | 46,08 | 853 | EPAL | 80 x 120 | 22 |
| 60 x 120 Lap | 2 | 1,44 | 32,5 | - | 30 | 43,20 | 976 | EPAL | 80 x 120 | 22 |



Cavalletto in legno
Wood A-Frame. Support en bois.
Holzgestell



Cassa
Crate . Caisse . Kiste



Pallet speciale con sponde
Special pallet with sides .
Palette spéciale avec bords.
Spezial-Palette mit Wandungen.



Epal/Pallet

| PEZZI SPECIALI. TRIMS | PCS/BOX | MQ/BOX | KG/BOX | PACKING | PACKING SIZE |
|--|---------|--------|--------|-----------------|------------------|
| 6 mm | | | | | |
| GRADINO COSTA RETTA 33 x 160 x 3,2h ** | 1 | - | 9 | PALLET SPECIALE | 168 x 97 x 40,9h |
| GRADINO COSTA RETTA 33 x 160 x 3,2h SX/DX ** | 1 | - | 10 | PALLET SPECIALE | 168 x 97 x 40,9h |
| GRADINO COSTA RETTA 33 x 120 x 3,2h ** | 2 | - | 14 | PALLET | 80 x 120 |
| GRADINO COSTA RETTA 33 x 120 x 3,2h SX/DX ** | 1 | - | 7 | PALLET | 80 x 120 |
| 8,8 mm | | | | | |
| BATTISCOPA 6,5 x 120 | 6 | - | 11,4 | PALLET | 80 x 120 |
| GRADINO COSTA RETTA 33 x 120 x 3,2h ** | 2 | - | 20,7 | PALLET | 80 x 120 |
| GRADINO COSTA RETTA 33 x 120 x 3,2h SX/DX ** | 1 | - | 10,8 | PALLET | 80 x 120 |

**** A disposizione solo su richiesta. Tempi di consegna: 30gg**
Available upon request only. Delivery terms: 30 days
Disponible seulement sur requête. Délais de livraison: 30 jours
Verfügbar auf Anfrage. Lieferzeit: 30 Tage

SILK PALACE



*Bianco
Imperiale*

MARMO E PIETRA



Gres Porcellanato. Porcelain tiles
Grès cérame. Feinsteinzeug
ISO 13006 - G - Bla_E ≤ 0,5%
UNI EN 14411

ANSI A - 326.3: 2021
W E T - D Y N A M I C
COEFFICIENT OF FRICTION

DCOF ≥ 0,42 | naturale

6 mm



120x280
48"x110"

* Nat Ret
Lap Ret

8,8 mm



60x120
24"x48"

* Nat Ret **R10A**
Lap Ret

* **Materic Touch per la superficie naturale**
Materic Touch for Natural surface
Toucher Matériel pour la surface naturelle
Materische Haptik für die natürliche Oberfläche

La struttura e il tono tra i fondi di spessore 6mm e 8,8mm potrebbero presentare differenze.
The structure and shade of the tiles with 6 mm and 8.8 mm thickness could show differences.
La structure et la teinte des carreaux de 6 mm et 8,8 mm d'épaisseur peuvent présenter des différences.
Die Struktur und der Farbton der Fliesen mit einer Dicke von 6 mm und 8,8 mm könnten Unterschiede aufweisen.

Bianco Imperiale

MARMO E PIETRA

NEW SERIES

100% DESIGN AND PRODUCTION OF ITALY

Sviluppo grafico per formato
Pattern by size
Développement graphique par format
Grafischer Entwurf für Format

120x280
6 mm

4

60x120
8,8 mm

15

Sviluppo Grafico

Pattern by size. Développement graphique par format.
Grafischer Entwurf für Format.

120x280 6 mm

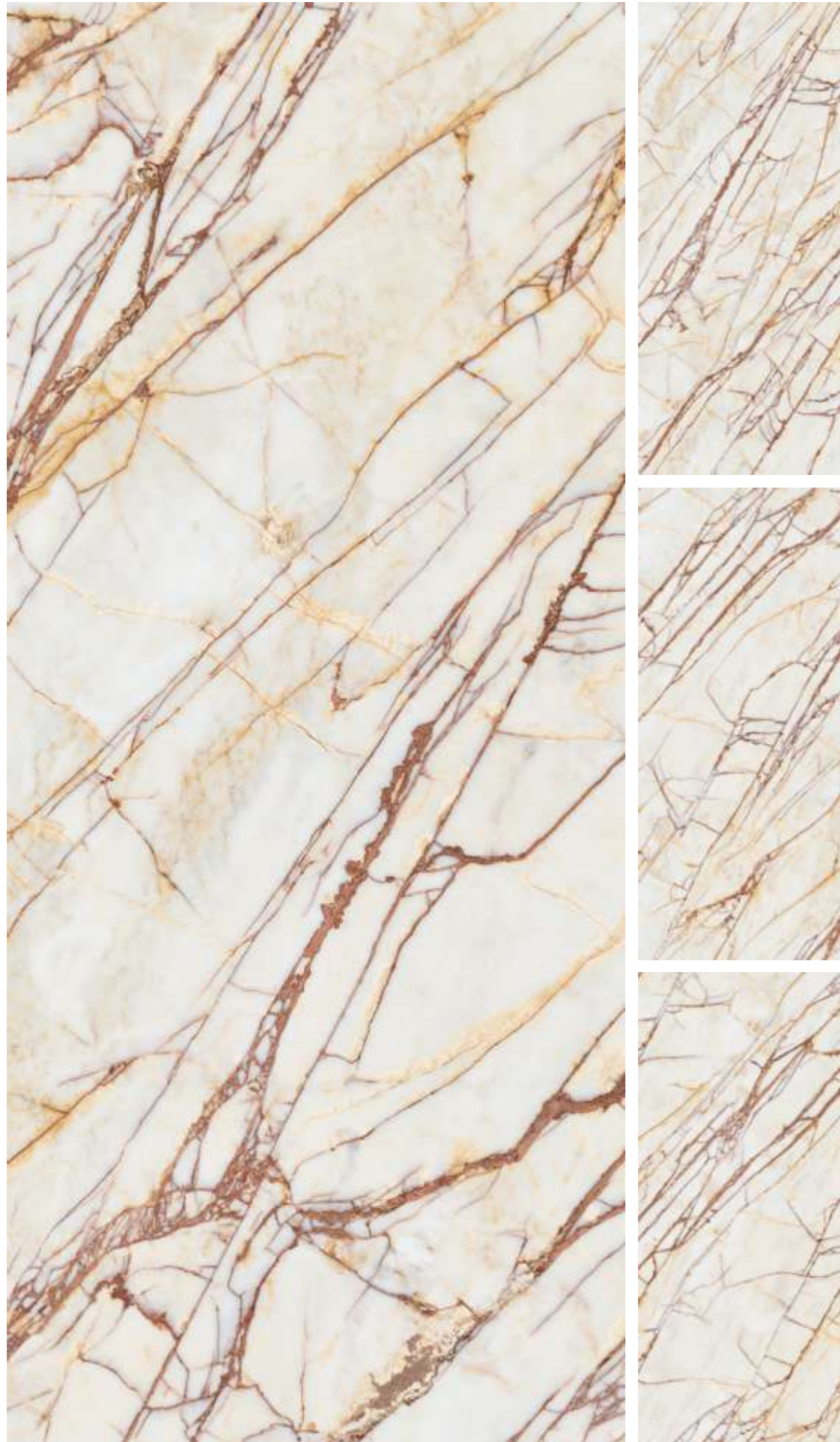

Composizione a vena continua

Continuous vein effect. Composition à nervures continues. Durchgehender marmorierung

COMPOSIZIONE DI 4 LASTRE A VENA CONTINUA FORMATO 120x280 SP 6 MM_63"x126" THK 6 MM
DISPONIBILE CON FINITURA NATURALE RETTIFICATA OPPURE LAPPATA RETTIFICATA



Composition with 4 continuous vein tiles size 120x280 sp 6 mm_48"x110" thk 6 mm available with natural rectified or lapped rectified finish.
Composition de 4 plaques à veines continues format 120x280 ép. 6 mm disponible avec finition naturelle rectifiée ou rodée rectifiée.
Zusammenstellung aus 4 st. Platten mit durchgehender marmorierung, format 120x280, st. 6 mm_48"x110" thk 6 mm verfügbar mit finish natur geschliffen oder geläpft geschliffen.

Le lastre sono fornite con le grafiche **random**. Possono essere fornite con **composizione a vena continua** con una maggiorazione nel prezzo e solo su richiesta esplicita del cliente.

The tiles are supplied with random graphics. They may be supplied with continuous vein effect at an additional charge and only if specifically requested by the customer.

Les plaques sont fournies avec graphiques aléatoires. Elles sont disponibles dans la composition à nervures continues avec une majoration sur le prix et seulement sur demande explicite du client.

Die platten werden mit zufälliger marmorierung geliefert. Sie können auf ausdrücklichen wunsch des kunden gegen aufpreis auch mit einer durchgehenden marmorierung geliefert werden.

Il disegno riprodotto è indicativo. La **grafica di chain** può mostrare discontinuità di vena nel passaggio da una lastra all'altra. Per questo motivo **differenze fino a 3 cm** devono essere considerate come caratteristica del prodotto.

The drawing is purely illustrative. The graphic design of chain may result in discontinuities in the veining between panels. Discontinuities of up to 3 cm are not defects, but are characteristic of the product.

Le dessin reproduit est indicatif. De même que le matériau naturel, le graphisme de chain peut présenter des marbrures discontinues d'une dalle à l'autre. Pour cette raison, les différences jusqu'à 3 cm doivent être considérées comme une caractéristique du produit.

Die wiedergegebene zeichnung ist eine musterzeichnung. Wie für das natürliche material kann auch die grafik von chain brüche der aderungen beim übergang von einer platte zur andern aufweisen. Aus diesem grund sind unterschiede bis zu 3 cm als charakteristik des produkts zu betrachten.

4 PATTERNS

60x120 8,8 mm

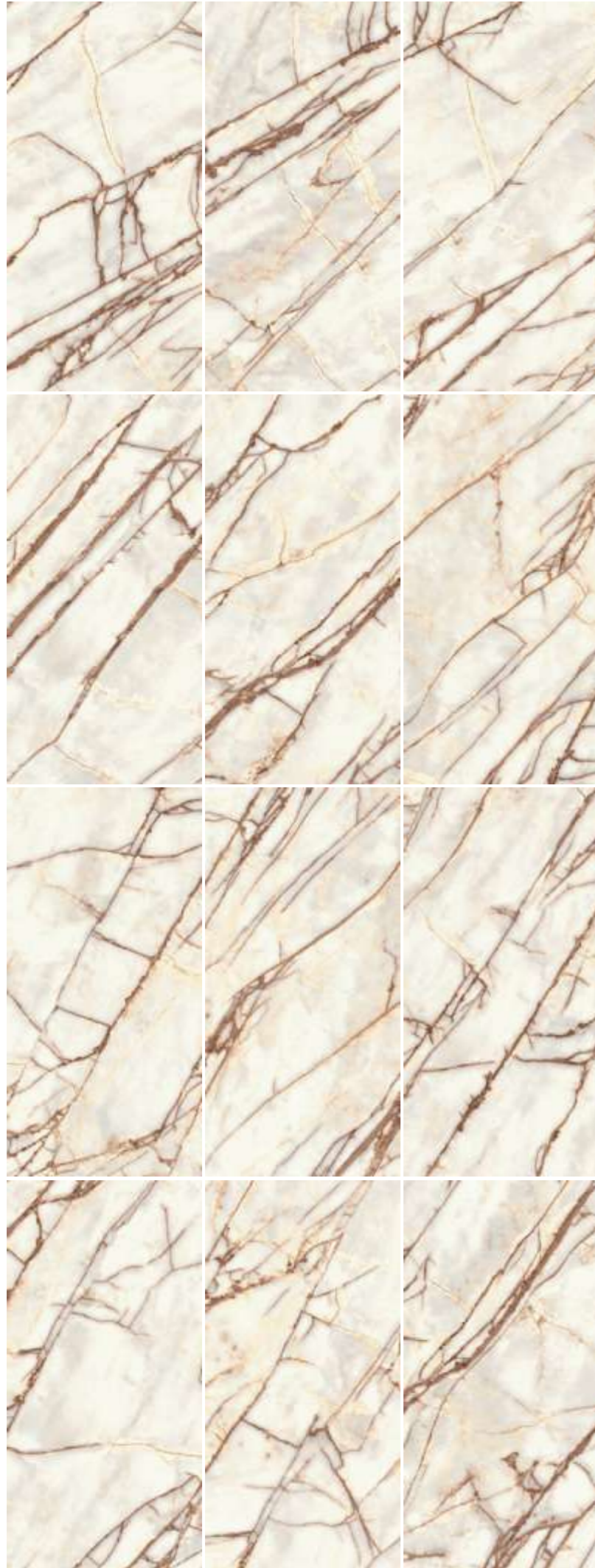

Lo sviluppo grafico mostra solo una selezione dei pattern disponibili. Il numero totale delle grafiche è indicato di seguito.

The graphic development shows only a selection of the available patterns. The total number of patterns is specified below.

Le développement graphique montre uniquement une sélection des motifs disponibles. Le nombre total de motifs est indiqué ci-dessous.

Die grafische Entwicklung zeigt nur eine Auswahl der verfügbaren Muster. Die Gesamtzahl der Muster ist unten angegeben.

15 PATTERNS

Bianco Imperiale

6 mm



120x280
48"x110"

| | * Nat Ret | Lap Ret |
|------------|-----------|---------|
| | 277001 | 277002 |
| Price code | M153 | M175 |

8,8 mm



60x120
24"x48"

| | * Nat Ret R10A | Lap Ret |
|------------|----------------|---------|
| | 277101 | 277102 |
| Price code | M109 | M125 |



* **Materic Touch per la superficie naturale**
Materic Touch for Natural surface
Toucher Matériel pour la surface naturelle
Materische Haptik für die natürliche Oberfläche

La struttura e il tono tra i fondi di spessore 6mm e 8,8mm potrebbero presentare differenze.
The structure and shade of the tiles with 6 mm and 8.8 mm thickness could show differences.
La structure et la teinte des carreaux de 6 mm et 8,8 mm d'épaisseur peuvent présenter des différences.
Die Struktur und der Farbton der Fliesen mit einer Dicke von 6 mm und 8,8 mm könnten Unterschiede aufweisen.

Pezzi Speciali / Trims. Pièces speciale. Die Sonderstücke

| 8,8 mm | Battiscopa Skirting 6,5x120 | | Gradino costa retta** Straight-edge stair** 33x120 | | Gradino costa retta SX - DX** Straight-edge step L-R corner** 33x120 | |
|------------|--------------------------------|---------|---|---------|---|------------------------|
| | Nat Ret R10A | Lap Ret | Nat Ret R10A | Lap Ret | Nat Ret R10A | Lap Ret |
| | 277501 | 277502 | 277601 | 277602 | 277621 SX 277611 DX | 277622 SX 277612 DX |
| Price code | P040 | P043 | P207 | P215 | P231 | P243 |

Calpestio (per la finitura naturale) . Foot traffic (for natural finish)

• BIANCO IMPERIALE HIGH

Imballi / Packings. Emballage. Verpackung

| | PCS/BOX | MQ/BOX | KG/BOX | PCS/PAL | BOX/PAL | MQ/PAL | KG/PAL | PACKING | PACKING SIZE | TARE (KG) |
|------------------|---------|--------|--------|---------|---------|--------|--------|------------------|-----------------|-----------|
| 6 mm | | | | | | | | | | |
| 120 x 280 | - | - | - | 20 | - | 67,20 | 974 | CASSA | 292 x 145 x 35h | 108 |
| | - | - | - | 44 | - | 147,84 | 2.140 | CAVALLETTO LEGNO | 290 x 75 x 161h | 145 |
| 8,8 mm | | | | | | | | | | |
| 60 x 120 Nat Ret | 2 | 1,44 | 27,8 | - | 32 | 46,08 | 889 | EPAL | 80 x 120 x 75h | 22 |
| 60 x 120 Lap Ret | 2 | 1,44 | 27,8 | - | 30 | 43,20 | 834 | EPAL | 80 x 120 x 75h | 22 |



Cavalletto in legno
Wood A-Frame. Support en bois.
Holzgestell



Cassa
Crate . Caisse . Kiste



Epal/Pallet

| Pezzi Speciali / Trims | PCS/BOX | MQ/BOX | KG/BOX | PACKING | PACKING SIZE |
|--|---------|--------|--------|---------|--------------|
| 8,8 mm | | | | | |
| BATTISCOPA 6,5 x 120 | 6 | - | 11,4 | PALLET | 80 x 120 |
| GRADINO COSTA RETTA 33 x 120 x 3,2h ** | 2 | - | 20,7 | PALLET | 80 x 120 |
| GRADINO COSTA RETTA 33 x 120 x 3,2h SX/DX ** | 1 | - | 10,8 | PALLET | 80 x 120 |

** A disposizione solo su richiesta. Tempi di consegna: 30gg
Available upon request only. Delivery terms: 30 days
Disponible seulement sur requête. Délais de livraison: 30 jours
Verfügbar auf Anfrage. Lieferzeit: 30 Tage



Macchia Antica

MARMO E PIETRA



Gres Porcellanato. Porcelain tiles
Grès cérame. Feinsteinzeug
ISO 13006 - G - Bla_E ≤ 0,5%
UNI EN 14411

ANSI A - 326.3: 2021
W E T - D Y N A M I C
COEFFICIENT OF FRICTION

DCOF ≥ 0,42 | naturale

6 mm



160x320
63"x126"
Nat Ret
Lap Ret



120x280
48"x110"
Nat Ret
Lap Ret



120x120
48"x48"
Lap Ret

8,8 mm



60x120
24"x48"
Nat Ret **R10A**
Lap Ret

Macchia Antica

MARMO E PIETRA

100% DESIGN AND PRODUCTION OF ITALY

Sviluppo grafico per formato
Pattern by size
Développement graphique par format
Grafischer Entwurf für Format

160x320
6 mm
5

120x280
6 mm
5

120x120
6 mm
10

60x120
8,8 mm
23

Sviluppo Grafico

Pattern by size. Développement graphique par format. Grafischer Entwurf für Format

160x320 6 mm

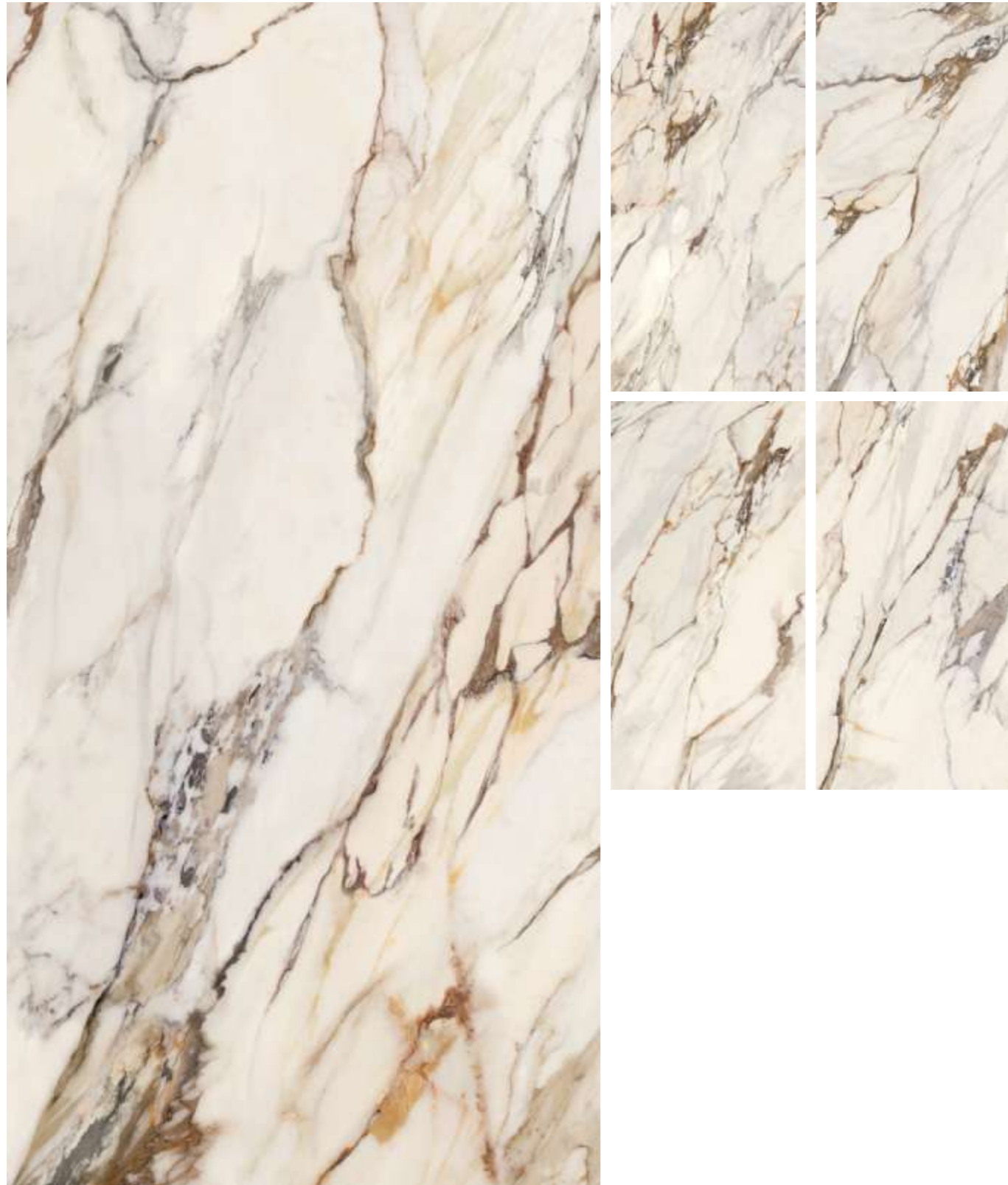

5 PATTERNS

Composizione a vena continua

Continuous vein effect. Composition à nervures continues. Durchgehender marmorierung

COMPOSIZIONE DI 5 LASTRE A VENA CONTINUA FORMATO 160x320 SP 6 MM _63"x126" THK 6 MM
DISPONIBILE CON FINITURA NATURALE RETTIFICATA OPPURE LAPPATA RETTIFICATA



Composition with 5 continuous vein tiles size 160x320 thk 6 mm _63"x126" thk 6 mm available with natural rectified or lapped rectified finish.
Composition de 5 plaques à veines continues format 160x320 ép. 6 Mm disponible avec finition naturelle rectifiée ou rodée rectifiée.
Zusammenstellung aus 5 st. Platten mit durchgehender marmorierung, format 160x320, st. 6 Mm _126"x63" thk 6 mm verfügbar mit finish natur geschliffen oder geläpft geschliffen.

COMPOSIZIONE DI 5 LASTRE A VENA CONTINUA FORMATO 120x280 SP 6 MM _48"x110" THK 6 MM
DISPONIBILE CON FINITURA NATURALE RETTIFICATA OPPURE LAPPATA RETTIFICATA



Composition with 5 continuous vein tiles size 120x280 sp 6 mm _48"x110" thk 6 mm available with natural rectified or lapped rectified finish.
Composition de 5 plaques à veines continues format 120x280 ép. 6 Mm disponible avec finition naturelle rectifiée ou rodée rectifiée.
Zusammenstellung aus 5 st. Platten mit durchgehender marmorierung, format 120x280, st. 6 Mm _48"x110" thk 6 mm verfügbar mit finish natur geschliffen oder geläpft geschliffen.

Le lastre sono fornite con le grafiche **random**. Possono essere fornite con **composizione a vena continua** con una maggiorazione nel prezzo e solo su richiesta esplicita del cliente.

The tiles are supplied with random graphics. They may be supplied with continuous vein effect at an additional charge and only if specifically requested by the customer.

Les plaques sont fournies avec graphiques aléatoires. Elles sont disponibles dans la composition à nervures continues avec une majoration sur le prix et seulement sur demande explicite du client.

Die platten werden mit zufälliger marmorierung geliefert. Sie können auf ausdrücklichen wunsch des kunden gegen aufpreis auch mit einer durchgehenden marmorierung geliefert werden.

Il disegno riprodotto è indicativo. La **grafica di chain** può mostrare discontinuità di vena nel passaggio da una lastra all'altra. Per questo motivo **differenze fino a 3 cm** devono essere considerate come caratteristica del prodotto.



The drawing is purely illustrative. The graphic design of chain may result in discontinuities in the veining between panels. Discontinuities of up to 3 cm are not defects, but are characteristic of the product.

Le dessin reproduit est indicatif. De même que le matériau naturel, le graphisme de chain peut présenter des marbrures discontinues d'une dalle à l'autre. Pour cette raison, les différences jusqu'à 3 cm doivent être considérées comme une caractéristique du produit.

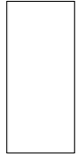

Die wiedergegebene zeichnung ist eine musterzeichnung. Wie für das natürliche material kann auch die grafik von chain brüche der aderungen beim übergang von einer platte zur andern aufweisen. Aus diesem grund sind unterschiede bis zu 3 cm als charakteristik des produkts zu betrachten.

Macchia Antica

6 mm



| | | | |
|---|---|---|---|
| |  |  |  |
| | 160x320 63"x126" | 120x280 48"x110" | 120x120 48"x48" |
| | Nat Ret | Lap Ret | Nat Ret |
| | Lap Ret | Nat Ret | Lap Ret |
| | Lap Ret | | |
|  | 163004 | 163003 | 163014 |
| | 163013 | 163023 | |
| Price code | M173 | M197 | M153 |
| | M175 | M169 | |

8,8 mm

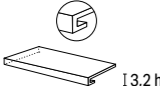
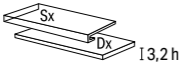

| | |
|---|---|
| |  |
| | 60x120 24"x48" |
| | Nat Ret R10A |
| | Lap Ret |
|  | 163104 |
| | 163103 |
| Price code | M109 |
| | M125 |

Pezzi Speciali / Trims. Pièces speciale. Die Sonderstücke

6 mm

| | | |
|---|---|---|
| |  |  |
| | Gradino costa retta** Straight-edge stair** | Gradino costa retta SX - DX** Straight-edge step L-R corner** |
| | 33x120 | 33x120 |
| | Lap Ret | Lap Ret |
|  | 163319 | 163320 SX |
| | | 163321 DX |
| Price code | P265 | P283 |

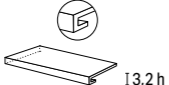
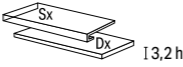
8,8 mm

| | | | |
|---|---|---|---|
| |  |  |  |
| | Battiscopa Skirting | Gradino costa retta** Straight-edge stair** | Gradino costa retta SX - DX** Straight-edge step L-R corner** |
| | 6,5x120 | 33x120 | 33x120 |
| | Nat Ret R10A | Lap Ret | Nat Ret R10A |
| | Lap Ret | Nat Ret R10A | Lap Ret |
| | Lap Ret | | |
|  | 163207 | 163206 | 163364 |
| | 163328 | 163347 SX | 163329 SX |
| | | 163366 DX | 163330 DX |
| Price code | P040 | P043 | P207 |
| | P215 | P231 | P243 |

Calpestio (per la finitura naturale) . Foot traffic (for natural finish)

• MACCHIA ANTICA  HIGH



Backsplash / Counter top
Macchia Antica Lap

Forniture
Metal Corten Nat

Imballi / Packings. Emballage. Verpackung

| | PCS/BOX | MQ/BOX | KG/BOX | PCS/PAL | BOX/PAL | MQ/PAL | KG/PAL | PACKING | PACKING SIZE | TARE (KG) |
|---------------|---------|--------|--------|---------|---------|--------|--------|------------------|-------------------|-----------|
| 6 mm | | | | | | | | | | |
| 160 x 320 | - | - | - | 14 | - | 71,68 | 1.039 | CASSA | 345 x 175 x 37h | 140 |
| | - | - | - | 44 | - | 225,28 | 3.262 | CAVALLETTO LEGNO | 330 x 75 x 193,5h | 210 |
| 120 x 280 | - | - | - | 20 | - | 67,20 | 1.081 | CASSA | 292 x 145 x 35h | 108 |
| | - | - | - | 44 | - | 147,84 | 2.140 | CAVALLETTO LEGNO | 290 x 75 x 161h | 145 |
| 120 x 120 | 2 | 2,88 | 42,5 | - | 24 | 69,12 | 1.020 | PALLET SPECIALE | 123 x 143 x 74h | 29 |
| 8,8 mm | | | | | | | | | | |
| 60 x 120 Nat | 2 | 1,44 | 26,9 | - | 32 | 46,08 | 860 | EPAL | 80 x 120 | 22 |
| 60 x 120 Lap | 2 | 1,44 | 32,5 | - | 30 | 43,20 | 976 | EPAL | 80 x 120 | 22 |



Cavalletto in legno
Wood A-Frame. Support en bois.
Holzgestell



Cassa
Crate . Caisse . Kiste



Pallet speciale con sponde
Special pallet with sides .
Palette spéciale avec bords.
Spezial-Palette mit Wandungen.



Epal/Pallet

| PEZZI SPECIALI. TRIMS | PCS/BOX | MQ/BOX | KG/BOX | PACKING | PACKING SIZE |
|--|---------|--------|--------|-----------------|------------------|
| 6 mm | | | | | |
| GRADINO COSTA RETTA 33 x 160 x 3,2h ** | 1 | - | 9 | PALLET SPECIALE | 168 x 97 x 40,9h |
| GRADINO COSTA RETTA 33 x 160 x 3,2h SX/DX ** | 1 | - | 10 | PALLET SPECIALE | 168 x 97 x 40,9h |
| GRADINO COSTA RETTA 33 x 120 x 3,2h ** | 2 | - | 14 | PALLET | 80 x 120 |
| GRADINO COSTA RETTA 33 x 120 x 3,2h SX/DX ** | 1 | - | 7 | PALLET | 80 x 120 |
| 8,8 mm | | | | | |
| BATTISCOPA 6,5 x 120 | 6 | - | 11,4 | PALLET | 80 x 120 |
| GRADINO COSTA RETTA 33 x 120 x 3,2h ** | 2 | - | 20,7 | PALLET | 80 x 120 |
| GRADINO COSTA RETTA 33 x 120 x 3,2h SX/DX ** | 1 | - | 10,8 | PALLET | 80 x 120 |

**** A disposizione solo su richiesta. Tempi di consegna: 30gg**
Available upon request only. Delivery terms: 30 days
Disponible seulement sur requête. Délais de livraison: 30 jours
Verfügbar auf Anfrage. Lieferzeit: 30 Tage



*Avorio
Segesta*

MARMO E PIETRA



Gres Porcellanato. Porcelain tiles
Grès cérame. Feinsteinzeug
ISO 13006 - G - Bla_E ≤ 0,5%
UNI EN 14411

ANSI A - 326.3: 2021
W E T D Y N A M I C
COEFFICIENT OF FRICTION

DCOF ≥ 0,42 | naturale

6 mm



120x280
48"x110"
* Nat Ret
Lap Ret

8,8 mm



60x120
24"x48"
* Nat Ret **R10A**
Lap Ret

* **Materic Touch per la superficie naturale**
Materic Touch for Natural surface
Toucher Matériel pour la surface naturelle
Materische Haptik für die natürliche Oberfläche

La struttura e il tono tra i fondi di spessore 6mm e 8,8mm potrebbero presentare differenze.
The structure and shade of the tiles with 6 mm and 8.8 mm thickness could show differences.
La structure et la teinte des carreaux de 6 mm et 8,8 mm d'épaisseur peuvent présenter des différences.
Die Struktur und der Farbton der Fliesen mit einer Dicke von 6 mm und 8,8 mm könnten Unterschiede aufweisen.

Avorio Segesta

MARMO E PIETRA

NEW SERIES

100% DESIGN AND PRODUCTION OF ITALY

Sviluppo grafico per formato
Pattern by size
Développement graphique par format
Grafischer Entwurf für Format

120x280
6 mm
4

60x120
8,8 mm
16

Sviluppo Grafico

Pattern by size. Développement graphique par format.
Grafischer Entwurf für Format.

120x280 6 mm



4 PATTERNS

60x120 8,8 mm



Lo sviluppo grafico mostra solo una selezione dei pattern disponibili. Il numero totale delle grafiche è indicato di seguito.

The graphic development shows only a selection of the available patterns. The total number of patterns is specified below.

Le développement graphique montre uniquement une sélection des motifs disponibles. Le nombre total de motifs est indiqué ci-dessous.

Die grafische Entwicklung zeigt nur eine Auswahl der verfügbaren Muster. Die Gesamtzahl der Muster ist unten angegeben.

16 PATTERNS

Avorio Segesta

6 mm

120x280
48"x110"

| | * Nat Ret | Lap Ret |
|------------|-----------|---------|
| | 273001 | 273002 |
| Price code | M153 | M175 |

8,8 mm

60x120
24"x48"

| | * Nat Ret R10A | Lap Ret |
|------------|----------------|---------|
| | 273101 | 273102 |
| Price code | M109 | M125 |



* **Materic Touch per la superficie naturale**
Materic Touch for Natural surface
Toucher Matériel pour la surface naturelle
Materische Haptik für die natürliche Oberfläche

La struttura e il tono tra i fondi di spessore 6mm e 8,8mm potrebbero presentare differenze.
The structure and shade of the tiles with 6 mm and 8.8 mm thickness could show differences.
La structure et la teinte des carreaux de 6 mm et 8,8 mm d'épaisseur peuvent présenter des différences.
Die Struktur und der Farbton der Fliesen mit einer Dicke von 6 mm und 8,8 mm könnten Unterschiede aufweisen.

Pezzi Speciali / Trims. Pièces speciale. Die Sonderstücke

8,8 mm

| | Battiscopa Skirting 6,5x120 | | Gradino costa retta** Straight-edge stair** 33x120 | | Gradino costa retta SX - DX** Straight-edge step L-R corner** 33x120 | |
|------------|--------------------------------|---------|--|---------|--|------------------------|
| | Nat Ret R10A | Lap Ret | Nat Ret R10A | Lap Ret | Nat Ret R10A | Lap Ret |
| | 273501 | 273502 | 273601 | 273602 | 273621 SX 273611 DX | 273622 SX 273612 DX |
| Price code | P040 | P043 | P207 | P215 | P231 | P243 |

Calpestio (per la finitura naturale) . Foot traffic (for natural finish)

• AVORIO SEGESTA HIGH



Wall
Avorio Segesta 120x280_48"x110" Lap Ret

Imballi / Packings. Emballage. Verpackung

| | PCS/BOX | MQ/BOX | KG/BOX | PCS/PAL | BOX/PAL | MQ/PAL | KG/PAL | PACKING | PACKING SIZE | TARE (KG) |
|------------------|---------|--------|--------|---------|---------|--------|--------|------------------|-----------------|-----------|
| 6 mm | | | | | | | | | | |
| 120 x 280 | - | - | - | 20 | - | 67,20 | 974 | CASSA | 292 x 145 x 35h | 108 |
| | - | - | - | 44 | - | 147,84 | 2.285 | CAVALLETTO LEGNO | 290 x 75 x 161h | 145 |
| 8,8 mm | | | | | | | | | | |
| 60 x 120 Nat Ret | 2 | 1,44 | 27,8 | - | 32 | 46,08 | 890 | EPAL | 80 x 120 x 75h | 22 |
| 60 x 120 Lap Ret | 2 | 1,44 | 27,8 | - | 30 | 43,20 | 834 | EPAL | 80 x 120 x 75h | 22 |



Cavalletto in legno
Wood A-Frame. Support en bois.
Holzgestell



Cassa
Crate . Caisse . Kiste



Epal/Pallet

| Pezzi Speciali / Trims | PCS/BOX | MQ/BOX | KG/BOX | PACKING | PACKING SIZE |
|---|---------|--------|--------|---------|--------------|
| 8,8 mm | | | | | |
| BATTISCOPA 6,5 x 120 | 6 | - | 11,4 | PALLET | 80 x 120 |
| GRADINO COSTA RETTA 33 x 120 x 3,2h ** | 2 | - | 20,7 | PALLET | 80 x 120 |
| GRADINO COSTA RETTA 33 x 120 x 3,2h SX/DX** | 1 | - | 10,8 | PALLET | 80 x 120 |

** A disposizione solo su richiesta. Tempi di consegna: 30gg
Available upon request only. Delivery terms: 30 days
Disponible seulement sur requête. Délais de livraison: 30 jours
Verfügbar auf Anfrage. Lieferzeit: 30 Tage



*Travertino
Classic*

MARMO E PIETRA



Gres Porcellanato. Porcelain tiles
Grès cérame. Feinsteinzeug
ISO 13006 - G - Bla_E ≤ 0,5%
UNI EN 14411

ANSI A - 326.3: 2021
W E T D Y N A M I C
COEFFICIENT OF FRICTION

DCOF ≥ 0,42 | naturale

6 mm



120x280
48"x110"
Nat Ret
Lap Ret

8,8 mm



60x120
24"x48"
Nat Ret
Lap Ret

Travertino Classic

MARMO E PIETRA

100% DESIGN AND PRODUCTION OF ITALY

Sviluppo grafico per formato
Pattern by size
Développement graphique par format
Grafischer Entwurf für Format

120x280
6 mm

9

60x120
8,8 mm

12

Sviluppo Grafico

Pattern by size. Développement graphique par format.
Grafischer Entwurf für Format.

120x280 6 mm



Lo sviluppo grafico mostra solo una selezione dei pattern disponibili. Il numero totale delle grafiche è indicato di seguito.

The graphic development shows only a selection of the available patterns. The total number of patterns is specified below.

Le développement graphique montre uniquement une sélection des motifs disponibles. Le nombre total de motifs est indiqué ci-dessous.

Die grafische Entwicklung zeigt nur eine Auswahl der verfügbaren Muster. Die Gesamtzahl der Muster ist unten angegeben.

9 PATTERNS



Wall
Travertino Classic 120x280_48"x110" Nat Ret

Travertino Classic

6 mm



120x280
48"x110"

| | Nat Ret | Lap Ret |
|------------|---------|---------|
| | 138503 | 138502 |
| Price code | M153 | M175 |

8,8 mm



60x120
24"x48"

| | Nat Ret | Lap Ret |
|------------|---------|---------|
| | 138014 | 138013 |
| Price code | M109 | M125 |

Pezzi Speciali / Trims. Pièces speciale. Die Sonderstücke

8,8 mm



Battiscopa
Skirting

6,5x120

| | Nat Ret | Lap Ret |
|------------|---------|---------|
| | 138104 | 138103 |
| Price code | P040 | P043 |

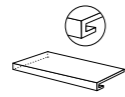

Gradino costa retta**
Straight-edge stair**

33x120

| | Nat Ret | Lap Ret |
|------------|---------|---------|
| | 138132 | 138129 |
| Price code | P207 | P215 |

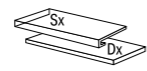

Gradino costa retta SX - DX**
Straight-edge step L-R corner**

33x120

| | Nat Ret | Lap Ret |
|------------|------------------------|------------------------|
| | 138134 SX 138133 DX | 138131 SX 138130 DX |
| Price code | P231 | P243 |

Calpestio (per la finitura naturale) . Foot traffic (for natural finish)

• TRAVERTINO CLASSIC HIGH



Imballi / Packings. Emballage. Verpackung

| | PCS/BOX | MQ/BOX | KG/BOX | PCS/PAL | BOX/PAL | MQ/PAL | KG/PAL | PACKING | PACKING SIZE | TARE (KG) |
|---------------|---------|--------|--------|---------|---------|--------|--------|------------------|-----------------|-----------|
| 6 mm | | | | | | | | | | |
| 120 x 280 | - | - | - | 20 | - | 67,20 | 974 | CASSA | 292 x 145 x 35h | 108 |
| | - | - | - | 44 | - | 147,84 | 2205 | CAVALLETTO LEGNO | 290 x 75 x 161h | 145 |
| 8,8 mm | | | | | | | | | | |
| 60 x 120 Nat | 2 | 1,44 | 26 | - | 32 | 46,08 | 832 | EPAL | 80 x 120 | 22 |
| 60 x 120 Lap | 2 | 1,44 | 27,9 | - | 30 | 43,20 | 837 | EPAL | 80 x 120 | 22 |

| PEZZI SPECIALI. TRIMS | PCS/BOX | MQ/BOX | KG/BOX | PACKING | PACKING SIZE |
|---|---------|--------|--------|---------|--------------|
| 8,8 mm | | | | | |
| BATTISCOPA 6,5 x 120 | 6 | - | 11,4 | PALLET | 80 x 120 |
| GRADINO COSTA RETTA 33 x 120 x 3,2h ** | 2 | - | 22 | PALLET | 80 x 120 |
| GRADINO COSTA RETTA 33 x 120 x 3,2h SX/DX** | 1 | - | 11 | PALLET | 80 x 120 |

**** A disposizione solo su richiesta. Tempi di consegna: 30gg**
Available upon request only. Delivery terms: 30 days
Disponible seulement sur requête. Délais de livraison: 30 jours
Verfügbar auf Anfrage. Lieferzeit: 30 Tage



Cavalletto in legno
Wood A-Frame. Support en bois.
Holzgestell



Cassa
Crate . Caisse . Kiste



Epal / Pallet



Aesthetica Hegel

MARMO E PIETRA

Gres Porcellanato. Porcelain tiles
Grès cérame. Feinsteinzeug
ISO 13006 - G - Bla_E ≤ 0,5%
UNI EN 14411

ANSI A - 326.3: 2021
W E T D Y N A M I C
COEFFICIENT OF FRICTION

DCOF ≥ 0,42 | naturale

6 mm



160x320
63"x126"
Nat Ret
Lap Ret



120x280
48"x110"
Nat Ret
Lap Ret



120x120
48"x48"
Nat Ret
Lap Ret

Decoro / Decor



Mosaico 30x30
12"x12"
Nat Ret
Lap Ret

8,8 mm



60x120
24"x48"
Lap Ret

Aesthetica Hegel

MARMO E PIETRA

100% DESIGN AND PRODUCTION OF ITALY

Sviluppo grafico per formato
Pattern by size
Développement graphique par format
Grafischer Entwurf für Format

160x320
6 mm
7

120x280
6 mm
11

120x120
6 mm
22

60x120
8,8 mm
25

Sviluppo Grafico

Pattern by size. Développement graphique par format.
Grafischer Entwurf für Format.

160x320 6 mm



7 PATTERNS



Aesthetica Hegel

6 mm

| | 160x320 63"x126" | | 120x280 48"x110" | | 120x120 48"x48" | | Mosaico 30x30 12"x12" | |
|------------|---------------------|---------|---------------------|---------|--------------------|---------|--------------------------|---------|
| | Nat Ret | Lap Ret | Nat Ret | Lap Ret | Nat Ret | Lap Ret | Nat Ret | Lap Ret |
| | 079002 | 079001 | 079569 | 079567 | 079032 | 079031 | 079142 | 079141 |
| Price code | M173 | M197 | M153 | M175 | M141 | M169 | M193 | M235 |

8,8 mm

| | 60x120 24"x48" |
|------------|-------------------|
| | Lap Ret |
| | 079061 |
| Price code | M125 |

Pezzi Speciali / Trims. Pièces speciale. Die Sonderstücke

6 mm

| | 33x120 | | 33x120 | |
|------------|---------|---------|------------------------|------------------------|
| | Nat Ret | Lap Ret | Nat Ret | Lap Ret |
| | 079221 | 079253 | 079229 SX 079225 DX | 079285 SX 079269 DX |
| Price code | P243 | P265 | P273 | P283 |

8,8 mm

| | 6,5x120 | 33x120 | 33x120 |
|------------|---------|---------|------------------------|
| | Lap Ret | Lap Ret | Lap Ret |
| | 079201 | 079261 | 079293 SX 079277 DX |
| Price code | P043 | P215 | P243 |

Calpestio (per la finitura naturale) . Foot traffic (for natural finish)

• AESTHETICA HEGEL HIGH



Wall & Top
Aesthetica Hegel 120x280_48"x110" Lap Ret

Imballi / Packings. Emballage. Verpackung

| | PCS/BOX | MQ/BOX | KG/BOX | PCS/PAL | BOX/PAL | MQ/PAL | KG/PAL | PACKING | PACKING SIZE | TARE (KG) |
|-----------------|---------|--------|--------|---------|---------|--------|--------|------------------|-------------------|-----------|
| 6 mm | | | | | | | | | | |
| 160 x 320 | - | - | - | 14 | - | 71,68 | 1.039 | CASSA | 345 x 175 x 37h | 140 |
| | - | - | - | 44 | - | 225,28 | 3.262 | CAVALLETTO LEGNO | 330 x 75 x 193,5h | 210 |
| 120 x 280 | - | - | - | 20 | - | 67,20 | 974 | CASSA | 292 x 145 x 35h | 108 |
| | - | - | - | 44 | - | 147,84 | 2.140 | CAVALLETTO LEGNO | 290 x 75 x 161h | 145 |
| 120 x 120 | 2 | 2,88 | 41,8 | - | 24 | 69,12 | 1.002 | PALLET SPECIALE | 123 x 143 x 74h | 29 |
| MOSAICO 30 x 30 | 9 | 0,81 | 11,8 | - | 60 | 48,60 | 710 | EPAL | 80 x 120 | 22 |
| 8,8 mm | | | | | | | | | | |
| 60 x 120 Lap | 2 | 1,44 | 27,9 | - | 30 | 43,20 | 837 | EPAL | 80 x 120 | 22 |



Cavalletto in legno
Wood A-Frame. Support en bois.
Holzgestell



Cassa
Crate . Caisse . Kiste



Pallet speciale con sponde
Special pallet with sides.
Palette spéciale avec bords.
Spezial-Palette mit Wandungen.



Epal / Pallet

| PEZZI SPECIALI. TRIMS | PCS/BOX | MQ/BOX | KG/BOX | PACKING | PACKING SIZE |
|--|---------|--------|--------|---------|--------------|
| 6 mm | | | | | |
| GRADINO COSTA RETTA 33 x 120 x 3,2h ** | 2 | - | 14 | PALLET | 80 x 120 |
| GRADINO COSTA RETTA 33 x 120 x 3,2h SX/DX ** | 1 | - | 7 | PALLET | 80 x 120 |
| 8,8 mm | | | | | |
| BATTISCOPA 6,5 x 120 | 6 | - | 11,4 | PALLET | 80 x 120 |
| GRADINO COSTA RETTA 33 x 120 x 3,2h ** | 2 | - | 22 | PALLET | 80 x 120 |
| GRADINO COSTA RETTA 33 x 120 x 3,2h SX/DX ** | 1 | - | 11 | PALLET | 80 x 120 |

** A disposizione solo su richiesta. Tempi di consegna: 30gg
Available upon request only. Delivery terms: 30 days
Disponible seulement sur requête. Délais de livraison: 30 jours
Verfügbar auf Anfrage. Lieferzeit: 30 Tage



LUXE
BEAUTY
SUITES



Aesthetica Wilde

MARMO E PIETRA

6 mm



160x320
63"x126"
Nat Ret
Lap Ret



120x280
48"x110"
Nat Ret
Lap Ret



120x120
48"x48"
Nat Ret
Lap Ret

Decoro / Decor



Mosaico 30x30
12"x12"
Nat Ret
Lap Ret

8,8 mm



60x120
24"x48"
Lap Ret

Aesthetica Wilde

MARMO E PIETRA

100% DESIGN AND PRODUCTION OF ITALY

Sviluppo grafico per formato
Pattern by size
Développement graphique par format
Grafischer Entwurf für Format

160x320
6 mm
7

120x280
6 mm
11

120x120
6 mm
22

60x120
8,8 mm
26

Sviluppo Grafico

Pattern by size. Développement graphique par format.
Grafischer Entwurf für Format.

160x320 6 mm



7 PATTERNS



Aesthetica Wilde

6 mm

| | 160x320 63"x126" | | 120x280 48"x110" | | 120x120 48"x48" | | Mosaico 30x30 12"x12" | |
|------------|---------------------|---------|---------------------|---------|--------------------|---------|--------------------------|---------|
| | Nat Ret | Lap Ret | Nat Ret | Lap Ret | Nat Ret | Lap Ret | Nat Ret | Lap Ret |
| | 079006 | 079005 | 079570 | 079568 | 079036 | 079035 | 079146 | 079145 |
| Price code | M173 | M197 | M153 | M175 | M141 | M169 | M193 | M235 |

8,8 mm

| | 60x120 24"x48" |
|------------|-------------------|
| | Lap Ret |
| | 079065 |
| Price code | M125 |

Pezzi Speciali / Trims. Pièces speciale. Die Sonderstücke

6 mm

| | 33x120 | | 33x120 | |
|------------|---------|---------|------------------------|------------------------|
| | Nat Ret | Lap Ret | Nat Ret | Lap Ret |
| | 079222 | 079254 | 079230 SX 079226 DX | 079286 SX 079270 DX |
| Price code | P243 | P265 | P273 | P283 |

8,8 mm

| | 6,5x120 | 33x120 | 33x120 |
|------------|---------|---------|------------------------|
| | Lap Ret | Lap Ret | Lap Ret |
| | 079202 | 079262 | 079294 SX 079278 DX |
| Price code | P043 | P215 | P243 |

Calpestio (per la finitura naturale) . Foot traffic (for natural finish)

• AESTHETICA WILDE  HIGH

**LUXE
BEAUTY
SUITES**



Wall & Floor
Aesthetica Wilde 120x280_48"x110" Lap Ret

Imballi / Packings. Emballage. Verpackung

| | PCS/BOX | MQ/BOX | KG/BOX | PCS/PAL | BOX/PAL | MQ/PAL | KG/PAL | PACKING | PACKING SIZE | TARE (KG) |
|-----------------|---------|--------|--------|---------|---------|--------|--------|------------------|-------------------|-----------|
| 6 mm | | | | | | | | | | |
| 160 x 320 | - | - | - | 14 | - | 71,68 | 1.039 | CASSA | 345 x 175 x 37h | 140 |
| | - | - | - | 44 | - | 225,28 | 3.262 | CAVALLETTO LEGNO | 330 x 75 x 193,5h | 210 |
| 120 x 280 | - | - | - | 20 | - | 67,20 | 974 | CASSA | 292 x 145 x 35h | 108 |
| | - | - | - | 44 | - | 147,84 | 2.140 | CAVALLETTO LEGNO | 290 x 75 x 161h | 145 |
| 120 x 120 | 2 | 2,88 | 41,8 | - | 24 | 69,12 | 1.002 | PALLET SPECIALE | 123 x 143 x 74h | 29 |
| MOSAICO 30 x 30 | 9 | 0,81 | 11,8 | - | 60 | 48,60 | 710 | EPAL | 80 x 120 | 22 |
| 8,8 mm | | | | | | | | | | |
| 60 x 120 Lap | 2 | 1,44 | 27,9 | - | 30 | 43,20 | 837 | EPAL | 80 x 120 | 22 |



Cavalletto in legno
Wood A-Frame. Support en bois.
Holzgestell



Cassa
Crate . Caisse . Kiste



Pallet speciale con sponde
Special pallet with sides .
Palette spéciale avec bords.
Spezial-Palette mit Wandungen.



Epal / Pallet

| PEZZI SPECIALI. TRIMS | PCS/BOX | MQ/BOX | KG/BOX | PACKING | PACKING SIZE |
|--|---------|--------|--------|---------|--------------|
| 6 mm | | | | | |
| GRADINO COSTA RETTA 33 x 120 x 3,2h ** | 2 | - | 14 | PALLET | 80 x 120 |
| GRADINO COSTA RETTA 33 x 120 x 3,2h SX/DX ** | 1 | - | 7 | PALLET | 80 x 120 |
| 8,8 mm | | | | | |
| BATTISCOPA 6,5 x 120 | 6 | - | 11,4 | PALLET | 80 x 120 |
| GRADINO COSTA RETTA 33 x 120 x 3,2h ** | 2 | - | 22 | PALLET | 80 x 120 |
| GRADINO COSTA RETTA 33 x 120 x 3,2h SX/DX ** | 1 | - | 11 | PALLET | 80 x 120 |

**** A disposizione solo su richiesta.**
Tempi di consegna: 30gg
Available upon request only. Delivery
terms: 30 days
Disponible seulement sur requête.
Délais de livraison: 30 jours
Verfügbar auf Anfrage. Lieferzeit:
30 Tage



Green Sky

MARMO E PIETRA



Gres Porcellanato. Porcelain tiles
Grès cérame. Feinsteinzeug
ISO 13006 - G - Bla_E ≤ 0.5%
UNIEN 14411

ANSI A - 326.3: 2021
W E T D Y N A M I C
COEFFICIENT OF FRICTION

6 mm



120x280
48"x110"
Lap Ret

8,8 mm



60x120
24"x48"
Lap Ret

Green Sky

MARMO E PIETRA

NEW SERIES

100% DESIGN AND PRODUCTION OF ITALY

Sviluppo grafico per formato
Pattern by size
Développement graphique par format
Grafischer Entwurf für Format

120x280
6 mm
4

60x120
8,8 mm
20

Sviluppo Grafico

Pattern by size. Développement graphique par format.
Grafischer Entwurf für Format.

120x280 6 mm

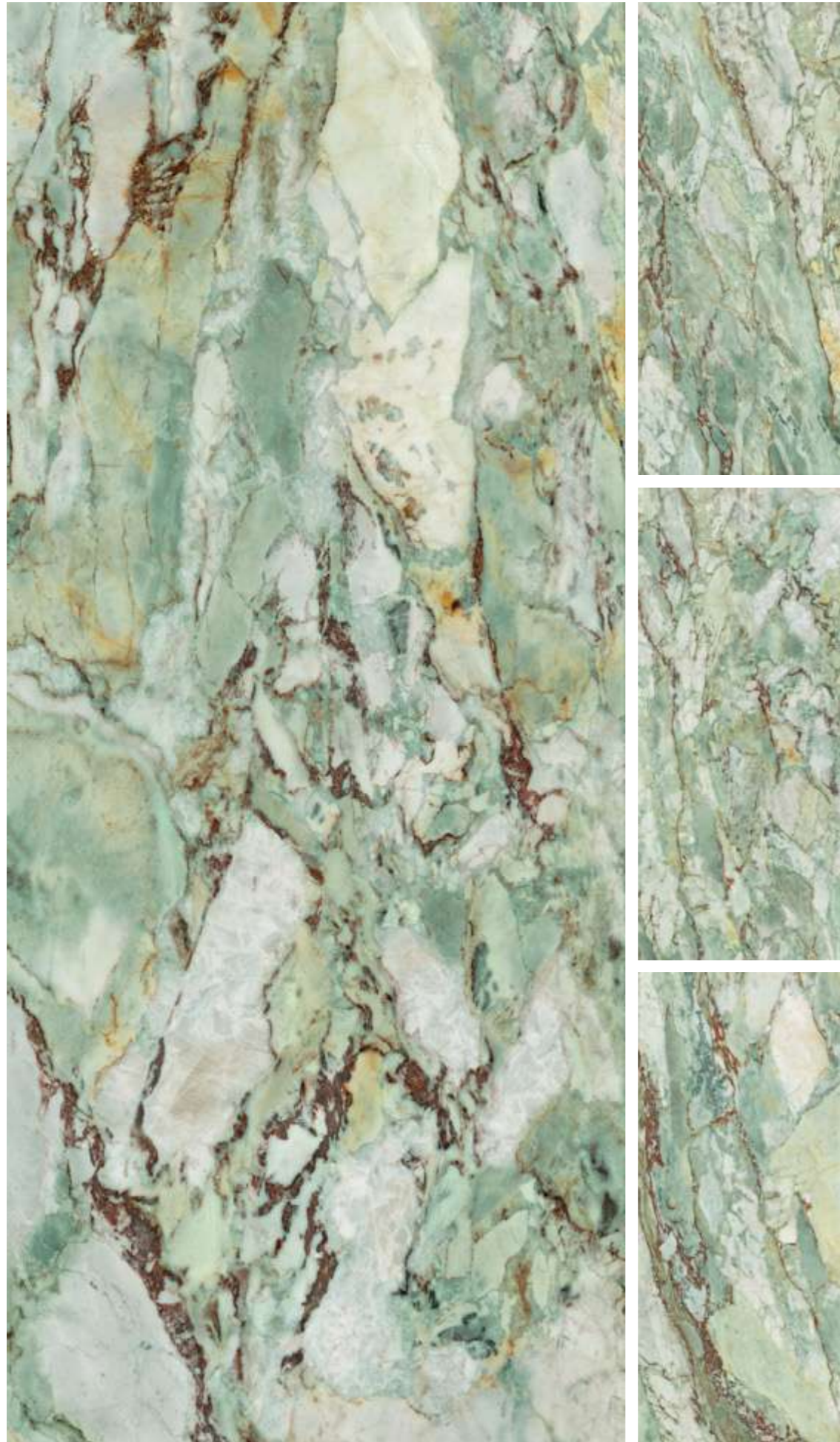

4 PATTERNS

60x120 8,8 mm

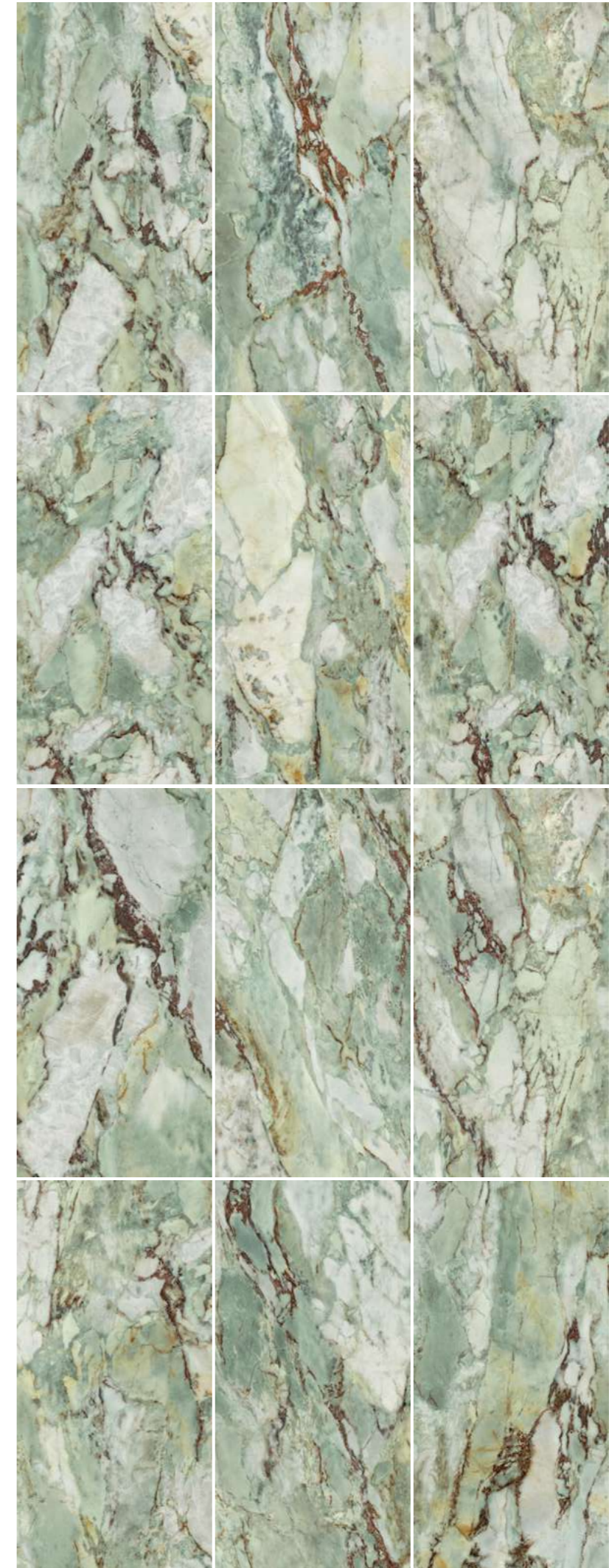

Lo sviluppo grafico mostra solo una selezione dei pattern disponibili. Il numero totale delle grafiche è indicato di seguito.



The graphic development shows only a selection of the available patterns. The total number of patterns is specified below.



Le développement graphique montre uniquement une sélection des motifs disponibles. Le nombre total de motifs est indiqué ci-dessous.

Die grafische Entwicklung zeigt nur eine Auswahl der verfügbaren Muster. Die Gesamtzahl der Muster ist unten angegeben.





20 PATTERNS

Green Sky

| | |
|---|---|
| 6 mm |  |
| | 120x280 48"x110" |
| | Lap Ret |
|  | 278002 |
| Price code | M175 |

| | |
|---|---|
| 8,8 mm |  |
| R 10 A naturale | 60x120 24"x48" |
| | Lap Ret |
|  | 278102 |
| Price code | M125 |

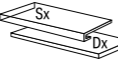
Pezzi Speciali / Trims. Pièces speciale. Die Sonderstücke

| | | | |
|---|---|---|--|
| 8,8 mm |  |  |  |
| R 10 A naturale | Battiscopa Skirting | Gradino costa retta** Straight-edge stair** | Gradino costa retta SX - DX** Straight-edge step L-R corner** |
| | 6,5x120 | 33x120 13,2h | 33x120 13,2h |
| | Lap Ret | Lap Ret | Lap Ret |
|  | 278502 | 278602 | 278622 SX 278612 DX |
| Price code | P043 | P215 | P243 |



Wall
Green Sky 120x280_48"x110" Lap Ret

Imballi / Packings. Emballage. Verpackung

| | PCS/BOX | MQ/BOX | KG/BOX | PCS/PAL | BOX/PAL | MQ/PAL | KG/PAL | PACKING | PACKING SIZE | TARE (KG) |
|------------------|---------|--------|--------|---------|---------|--------|--------|------------------|-----------------|-----------|
| 6 mm | | | | | | | | | | |
| 120 x 280 | - | - | - | 20 | - | 67,20 | 974 | CASSA | 292 x 145 x 35h | 108 |
| | - | - | - | 44 | - | 147,84 | 2.140 | CAVALLETTO LEGNO | 290 x 75 x 161h | 145 |
| 8,8 mm | | | | | | | | | | |
| 60 x 120 Lap Ret | 2 | 1,44 | 27,8 | - | 30 | 43,20 | 834 | EPAL | 80 x 120 x 75h | 22 |



Cavalletto in legno
Wood A-Frame. Support en bois.
Holzgestell



Cassa
Crate . Caisse . Kiste



Epal/Pallet

| Pezzi Speciali / Trims | PCS/BOX | MQ/BOX | KG/BOX | PACKING | PACKING SIZE |
|---|---------|--------|--------|---------|--------------|
| 8,8 mm | | | | | |
| BATTISCOPA 6,5 x 120 | 6 | - | 11,4 | PALLET | 80 x 120 |
| GRADINO COSTA RETTA 33 x 120 x 3,2h ** | 2 | - | 20,7 | PALLET | 80 x 120 |
| GRADINO COSTA RETTA 33 x 120 x 3,2h SX/DX** | 1 | - | 10,8 | PALLET | 80 x 120 |

**** A disposizione solo su richiesta. Tempi di consegna: 30gg**
Available upon request only. Delivery terms: 30 days
Disponible seulement sur requête. Délais de livraison: 30 jours
Verfügbar auf Anfrage. Lieferzeit: 30 Tage

Onice Iride

MARMO E PIETRA



COBALTO

GIADA

ARGENTO

AVORIO

AMBRA

MALAGA



Gres Porcellanato. Porcelain tiles
Grès cérame. Feinsteinzeug
ISO 13006 - G - Bla_E ≤ 0.5%
UNIEN 14411

ANSI A - 326.3: 2021
W E T D Y N A M I C
COEFFICIENT OF FRICTION

6 mm



160x320
63"x126"
Lap Ret



80x160
31 1/2"x63"
Lap Ret



120x280
48"x110"
Lap Ret



120x120
48"x48"
Lap Ret

modular system

8,8 mm



60x120
24"x48"
Lap Ret

Onice Iride

MARMO E PIETRA

100% DESIGN AND PRODUCTION OF ITALY

Sviluppo grafico per formato
Pattern by size
Développement graphique par format
Grafischer Entwurf für Format

160x320
6 mm
4

120x280
6 mm
4

120x120
6 mm
8

80x160
6 mm
16

60x120
8,8 mm
24

Sviluppo Grafico

Pattern by size. Développement graphique par format.
Grafischer Entwurf für Format.

COBALTO 160x320 6 mm

PATTERNS 4

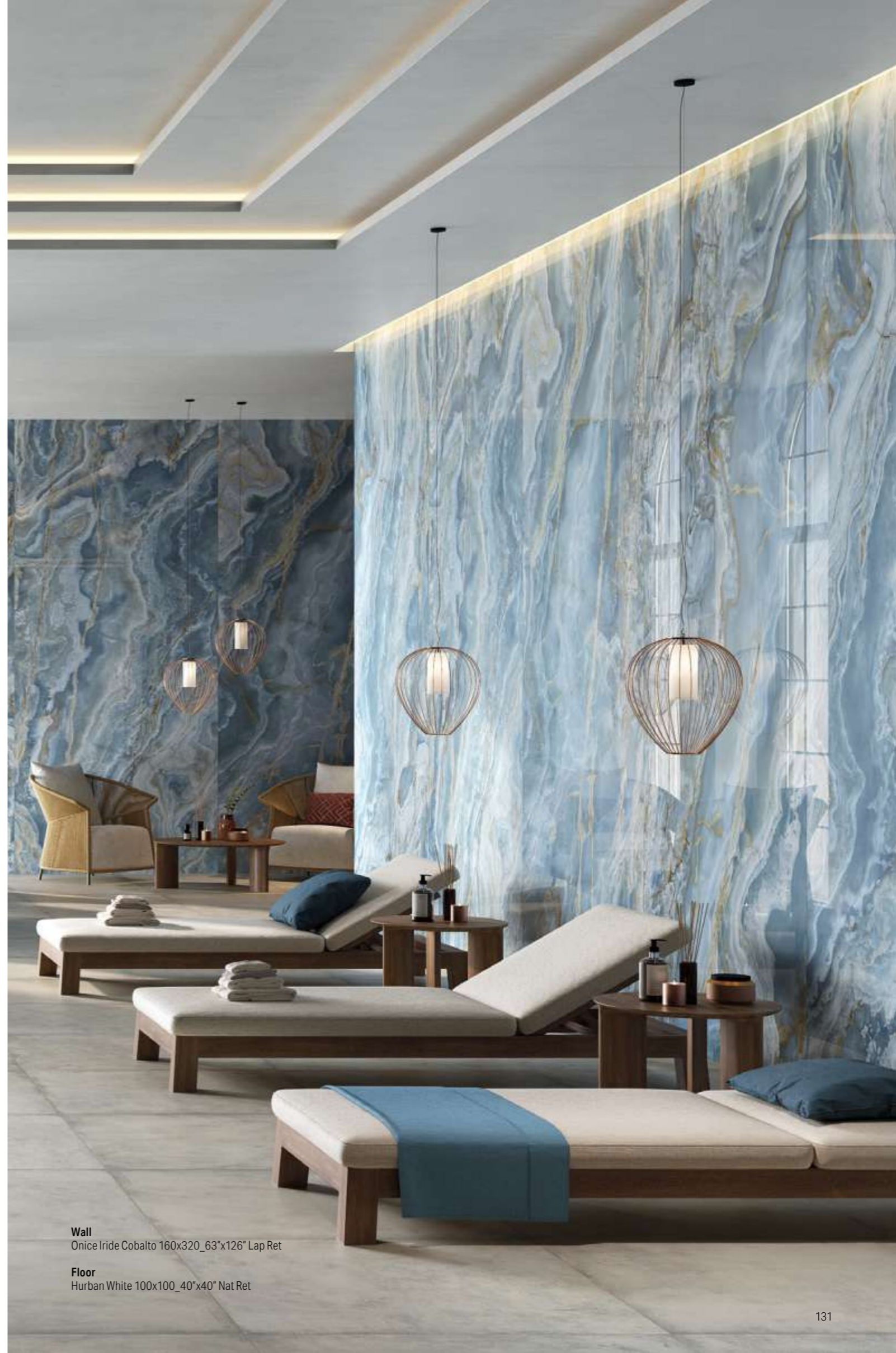
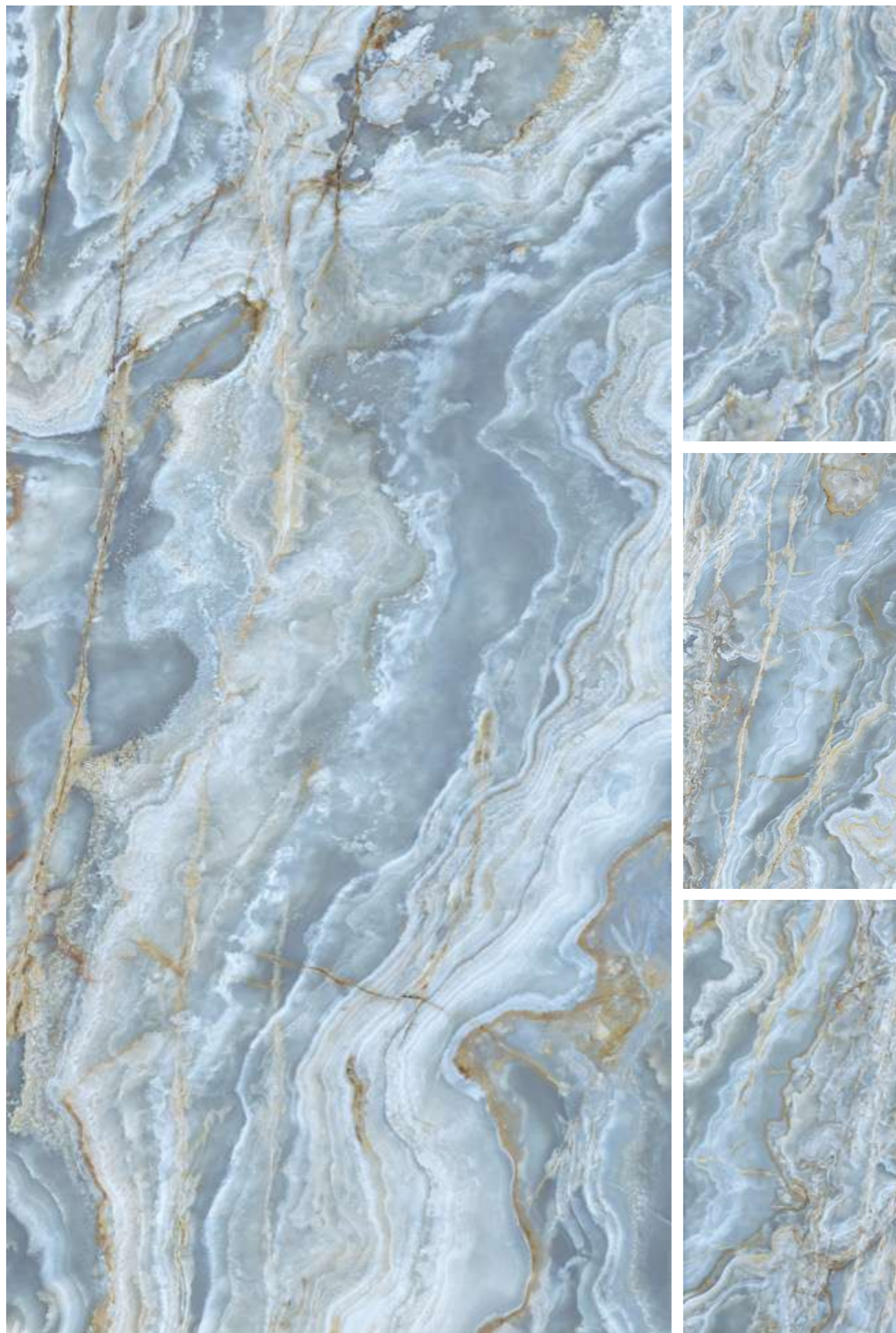

Wall
Onice Iride Cobalto 160x320_63"x126" Lap Ret

Floor
Hurban White 100x100_40"x40" Nat Ret

Onice Iride

6 mm

| | 160x320 63"x126" | 80x160 31 1/2"x63" | 120x280 48"x110" | 120x120 48"x48" |
|------------|---------------------|-----------------------|---------------------|--------------------|
| | Lap Ret | Lap Ret | Lap Ret | Lap Ret |
| COBALTO | 173005 | 173045 | 173025 | 173035 |
| GIADA | - | - | 173022 | 173032 |
| ARGENTO | 173006 | 173046 | 173026 | 173036 |
| AVORIO | 173001 | 173041 | 173021 | 173031 |
| AMBRA | 173004 | 173044 | 173024 | 173034 |
| MALAGA | 173003 | 173043 | 173023 | 173033 |
| Price code | M197 | M169 | M175 | M169 |

8,8 mm

| | 60x120 24"x48" |
|------------|-------------------|
| | Lap Ret |
| COBALTO | 173065 |
| GIADA | 173062 |
| ARGENTO | 173066 |
| AVORIO | 173061 |
| AMBRA | 173064 |
| MALAGA | 173063 |
| Price code | M125 |

Pezzi Speciali / Trims. Pièces speciale. Die Sonderstücke

6 mm

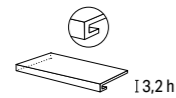

Gradino costa retta**
Straight-edge stair**

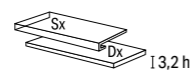

Gradino costa retta SX - DX**
Straight-edge step L-R corner**

| | 33x160 | 33x120 | 33x160 | 33x120 |
|------------|---------|---------|------------------------|------------------------|
| | Lap Ret | Lap Ret | Lap Ret | Lap Ret |
| COBALTO | 173205 | 173225 | 173207 SX 173299 DX | 173227 SX 173233 DX |
| GIADA | 173202 | 173222 | 173208 SX 173214 DX | 173228 SX 173234 DX |
| ARGENTO | 173240 | 173226 | 173300 SX 173215 DX | 173229 SX 173235 DX |
| AVORIO | 173201 | 173221 | 173210 SX 173216 DX | 173230 SX 173236 DX |
| AMBRA | 173204 | 173224 | 173212 SX 173218 DX | 173232 SX 173238 DX |
| MALAGA | 173239 | 173223 | 173211 SX 173217 DX | 173231 SX 173237 DX |
| Price code | P323 | P265 | P339 | P283 |

8,8 mm



Battiscopa
Skirting

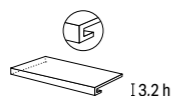

Gradino costa retta**
Straight-edge stair**

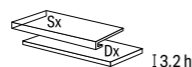

Gradino costa retta SX - DX**
Straight-edge step L-R corner**

| | 6,5x120 | 33x120 | 33x120 |
|------------|---------|---------|------------------------|
| | Lap Ret | Lap Ret | Lap Ret |
| COBALTO | 173115 | 173245 | 173247 SX 173253 DX |
| GIADA | 173112 | 173242 | 173248 SX 173254 DX |
| ARGENTO | 173116 | 173246 | 173249 SX 173255 DX |
| AVORIO | 173111 | 173241 | 173250 SX 173256 DX |
| AMBRA | 173114 | 173244 | 173252 SX 173258 DX |
| MALAGA | 173113 | 173243 | 173251 SX 173257 DX |
| Price code | P043 | P215 | P243 |



Wall
Onice Iride Giada 120x280_48"x110" Lap Ret

Floor
Onice Iride Argento 120x280_48"x110" Lap Ret

Imballi / Packings. Emballage. Verpackung

| | PCS/BOX | MQ/BOX | KG/BOX | PCS/PAL | BOX/PAL | MQ/PAL | KG/PAL | PACKING | PACKING SIZE | TARE (KG) |
|---------------|---------|--------|--------|---------|---------|--------|--------|------------------|-------------------|-----------|
| 6 mm | | | | | | | | | | |
| 160 x 320 | - | - | - | 14 | - | 74,24 | 1.039 | CASSA | 345 x 175 x 37h | 140 |
| | - | - | - | 44 | - | 225,28 | 3.262 | CAVALLETTO LEGNO | 330 x 75 x 193,5h | 210 |
| 120 x 280 | - | - | - | 20 | - | 67,20 | 974 | CASSA | 292 x 145 x 35h | 108 |
| | - | - | - | 44 | - | 147,84 | 2.140 | CAVALLETTO LEGNO | 290 x 75 x 161h | 145 |
| 120 x 120 | 2 | 2,88 | 41,8 | - | 24 | 69,12 | 1.002 | PALLET SPECIALE | 123 x 143 x 74h | 29 |
| 80 x 160 | 2 | 2,56 | 74,2 | - | 15 | 38,40 | 1.114 | PALLET SPECIALE | 168 x 97 x 40,9h | 29,4 |
| 8,8 mm | | | | | | | | | | |
| 60 x 120 Lap | 2 | 1,44 | 28,5 | - | 30 | 43,20 | 855 | EPAL | 80 x 120 | 22 |



Cavalletto in legno
Wood A-Frame. Support en bois.
Holzgestell



Cassa
Crate . Caisse . Kiste



Pallet speciale con sponde
Special pallet with sides.
Palette spéciale avec bords.
Spezial-Palette mit Wandungen.



Epal / Pallet

| PEZZI SPECIALI. TRIMS | PCS/BOX | MQ/BOX | KG/BOX | PACKING | PACKING SIZE |
|--|---------|--------|--------|-----------------|------------------|
| 6 mm | | | | | |
| GRADINO COSTA RETTA 33 x 160 x 3,2h ** | 1 | - | 9 | PALLET SPECIALE | 168 x 97 x 40,9h |
| GRADINO COSTA RETTA 33 x 160 x 3,2h SX/DX ** | 1 | - | 10 | PALLET SPECIALE | 168 x 97 x 40,9h |
| GRADINO COSTA RETTA 33 x 120 x 3,2h ** | 2 | - | 14 | EPAL | 80 x 120 |
| GRADINO COSTA RETTA 33 x 120 x 3,2h SX/DX ** | 1 | - | 7 | EPAL | 80 x 120 |
| 8,8 mm | | | | | |
| BATTISCOPA 6,5 x 120 | 6 | - | 11,4 | PALLET | 80 x 120 |
| GRADINO COSTA RETTA 33 x 120 x 3,2h ** | 2 | - | 22 | PALLET | 80 x 120 |
| GRADINO COSTA RETTA 33 x 120 x 3,2h SX/DX ** | 1 | - | 11 | PALLET | 80 x 120 |

**** A disposizione solo su richiesta. Tempi di consegna: 30gg**
Available upon request only. Delivery terms: 30 days
Disponible seulement sur requête. Délais de livraison: 30 jours
Verfügbar auf Anfrage. Lieferzeit: 30 Tage



Nautilus

MARMO E PIETRA



Gres Porcellanato. Porcelain tiles
Grès cérame. Feinsteinzeug
ISO 13006 - G - Bla_E ≤ 0.5%
UNI EN 14411

ANSI A - 326.3: 2021
W E T D Y N A M I C
COEFFICIENT OF FRICTION

6 mm



160x320
63"x126"
Lap Ret



120x280
48"x110"
Lap Ret



120x120
48"x48"
Lap Ret

Decoro / Decor



Mosaico 30x30
12"x12"
Lap Ret

Nautilus

MARMO E PIETRA

100% DESIGN AND PRODUCTION OF ITALY

Sviluppo grafico per formato
Pattern by size
Développement graphique par format
Grafischer Entwurf für Format

160x320
6 mm
6

120x280
6 mm
10

120x120
6 mm
20

Sviluppo Grafico

Pattern by size. Développement graphique par format.
Grafischer Entwurf für Format.

160x320 6 mm

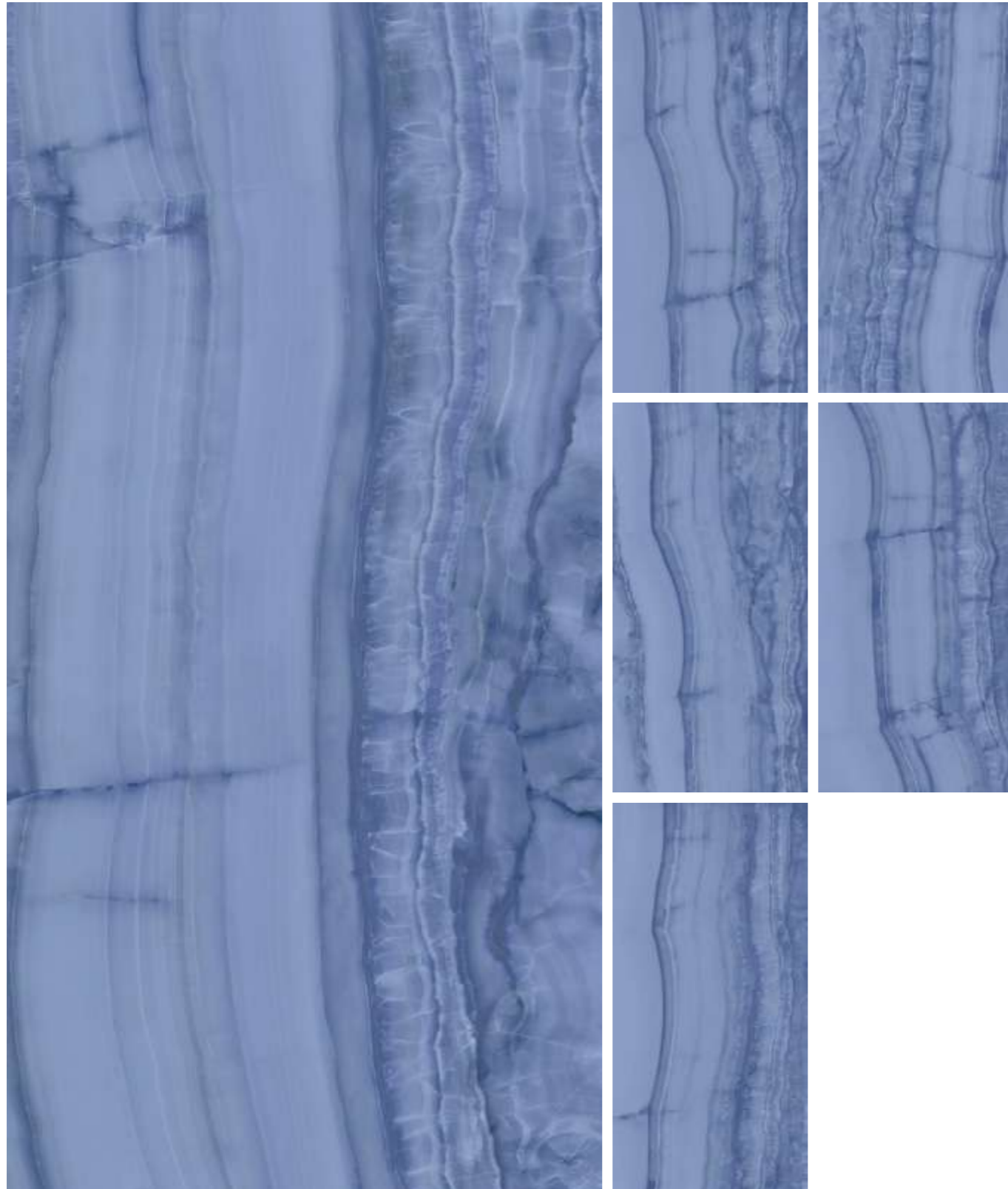

6 PATTERNS

Nautilus

| 6 mm | 160x320 63"x126" | 120x280 48"x110" | 120x120 48"x48" | Mosaico 30x30 12"x12" |
|------------|---------------------|---------------------|--------------------|--------------------------|
| | Lap Ret | Lap Ret | Lap Ret | Lap Ret |
| | 113001 | 113050 | 113030 | 113302 |
| Price code | M229 | M207 | M207 | M269 |

Pezzi Speciali / Trims. Pièces speciale. Die Sonderstücke

| 6 mm | Gradino costa retta** Straight-edge stair** | Gradino costa retta SX - DX** Straight-edge step L-R corner** |
|------------|--|--|
| | 33x120 | 33x120 |
| | Lap Ret | Lap Ret |
| | 113210 | 113212SX 113211DX |
| Price code | P271 | P285 |

Imballi / Packings. Emballage. Verpackung

| 6 mm | PCS/BOX | MQ/BOX | KG/BOX | PCS/PAL | BOX/PAL | MQ/PAL | KG/PAL | PACKING | PACKING SIZE | TARE (KG) |
|-----------------|---------|--------|--------|---------|---------|--------|--------|------------------|-------------------|-----------|
| 160 x 320 | - | - | - | 14 | - | 71,68 | 1.039 | CASSA | 345 x 175 x 37h | 140 |
| | - | - | - | 44 | - | 225,28 | 3.262 | CAVALLETTO LEGNO | 330 x 75 x 193,5h | 210 |
| 120 x 280 | - | - | - | 20 | - | 67,20 | 974 | CASSA | 292 x 145 x 35h | 108 |
| | - | - | - | 44 | - | 147,84 | 2.140 | CAVALLETTO LEGNO | 290 x 75 x 161h | 145 |
| 120 x 120 | 2 | 2,88 | 41,8 | - | 24 | 69,12 | 1.002 | PALLET SPECIALE | 123 x 143 x 74h | 29 |
| MOSAICO 30 x 30 | 9 | 0,81 | 11,9 | - | 60 | 48,60 | 716 | EPAL | 80 x 120 | 22 |



Cavalletto in legno
Wood A-Frame. Support en bois.
Holzgestell



Cassa
Crate. Caisse. Kiste



Pallet speciale con sponde
Special pallet with sides.
Palette spéciale avec bords.
Spezial-Palette mit Wandungen.



Epal / Pallet

| PEZZI SPECIALI. TRIMS | PCS/BOX | MQ/BOX | KG/BOX | PACKING | PACKING SIZE |
|--|---------|--------|--------|---------|--------------|
| 6 mm GRADINO COSTA RETTA 33 x 120 x 3,2h ** | 2 | - | 14 | PALLET | 80 x 120 |
| GRADINO COSTA RETTA 33 x 120 x 3,2h SX/DX ** | 1 | - | 7 | PALLET | 80 x 120 |

** A disposizione solo su richiesta. Tempi di consegna: 30gg
Available upon request only. Delivery terms: 30 days
Disponible seulement sur requête. Délais de livraison: 30 jours
Verfügbar auf Anfrage. Lieferzeit: 30 Tage

Breccia Argentum

MARMO E PIETRA





Gres Porcellanato. Porcelain tiles
Grès cérame. Feinsteinzeug
ISO 13006 - G - Bla_E ≤ 0,5%
UNI EN 14411

ANSI A - 326.3: 2021
W E T D Y N A M I C
COEFFICIENT OF FRICTION

DCOF ≥ 0,42 | naturale

6 mm



160x320
63"x126"
Nat Ret
Lap Ret



120x280
48"x110"
Nat Ret
Lap Ret



120x120
48"x48"
Lap Ret

8,8 mm



60x120
24"x48"
Lap Ret

Breccia Argentum

MARMO E PIETRA

100% DESIGN AND PRODUCTION OF ITALY

Sviluppo grafico per formato
Pattern by size
Développement graphique par format
Grafischer Entwurf für Format

160x320
6 mm
4

120x280
6 mm
4

120x120
6 mm
8

60x120
8,8 mm
20

Sviluppo Grafico

Pattern by size. Développement graphique par format.
Grafischer Entwurf für Format.

160x320 6 mm

PATTERNS 4







Wall
Breccia Argentum 160x320_63"x126" Nat Ret



Floor
Breccia Argentum 160x320_63"x126" Lap Ret

Breccia Argentum

6 mm



| | | | | | |
|---|---|---|---|---------------|---------------|
| |  |  |  | | |
| | 160x320 63"x126" | 120x280 48"x110" | 120x120 48"x48" | | |
| | Nat Ret | Lap Ret | Nat Ret | Lap Ret | Lap Ret |
|  | 163002 | 163001 | 163012 | 163011 | 163021 |
| Price code | M173 | M197 | M153 | M175 | M169 |

8,8 mm

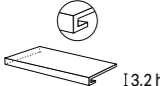
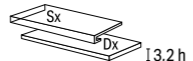

| | |
|---|---|
| |  |
| | 60x120 24"x48" |
| | Lap Ret |
|  | 163101 |
| Price code | M125 |

Pezzi Speciali / Trims. Pièces speciale. Die Sonderstücke

6 mm

| | | |
|---|---|---|
| |  |  |
| | Gradino costa retta** Straight-edge stair** | Gradino costa retta SX - DX** Straight-edge step L-R corner** |
| | 33x120 | 33x120 |
| | Lap Ret | Lap Ret |
|  | 163304 | 163928 SX 163306 DX |
| Price code | P265 | P283 |

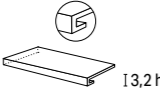
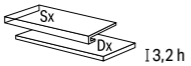
8,8 mm

| | | | |
|---|---|---|---|
| |  |  |  |
| | Battiscopa Skirting | Gradino costa retta** Straight-edge stair** | Gradino costa retta SX - DX** Straight-edge step L-R corner** |
| | 6,5x120 | 33x120 | 33x120 |
| | Lap Ret | Lap Ret | Lap Ret |
|  | 163203 | 163313 | 163314 SX 163315 DX |
| Price code | P043 | P215 | P243 |

Calpestio (per la finitura naturale) . Foot traffic (for natural finish)

• BRECCIA ARGENTUM  MEDIUM



Floor
Breccia Argentum 160x320 . 63"x126" Lap Ret

Imballi / Packings. Emballage. Verpackung

| | PCS/BOX | MQ/BOX | KG/BOX | PCS/PAL | BOX/PAL | MQ/PAL | KG/PAL | PACKING | PACKING SIZE | TARE (KG) |
|---------------|---------|--------|--------|---------|---------|--------|--------|------------------|-------------------|-----------|
| 6 mm | | | | | | | | | | |
| 160 x 320 | - | - | - | 14 | - | 71,68 | 1.039 | CASSA | 345 x 175 x 37h | 140 |
| | - | - | - | 44 | - | 225,28 | 3.262 | CAVALLETTO LEGNO | 330 x 75 x 193,5h | 210 |
| 120 x 280 | - | - | - | 20 | - | 67,20 | 974 | CASSA | 292 x 145 x 35h | 108 |
| | - | - | - | 44 | - | 147,84 | 2.144 | CAVALLETTO LEGNO | 290 x 75 x 161h | 145 |
| 120 x 120 | 2 | 2,88 | 42,5 | - | 24 | 69,12 | 1.020 | PALLET SPECIALE | 123 x 143 x 74h | 29 |
| 8,8 mm | | | | | | | | | | |
| 60 x 120 | 2 | 1,44 | 32,5 | - | 30 | 43,20 | 976 | EPAL | 80 x 120 | 22 |



Cavalletto in legno
Wood A-Frame. Support en bois.
Holzgestell



Cassa
Crate . Caisse . Kiste



Pallet speciale con sponde
Special pallet with sides .
Palette spéciale avec bords.
Spezial-Palette mit Wandungen.



Epal

| PEZZI SPECIALI. TRIMS | PCS/BOX | MQ/BOX | KG/BOX | PACKING | PACKING SIZE |
|--|---------|--------|--------|-----------------|------------------|
| 6 mm | | | | | |
| GRADINO COSTA RETTA 33 x 160 x 3,2h ** | 1 | - | 9 | PALLET SPECIALE | 168 x 97 x 40,9h |
| GRADINO COSTA RETTA 33 x 160 x 3,2h SX/DX ** | 1 | - | 10 | PALLET SPECIALE | 168 x 97 x 40,9h |
| GRADINO COSTA RETTA 33 x 120x3,2h ** | 2 | - | 14 | PALLET | 80 x 120 |
| GRADINO COSTA RETTA 33 x 120 x 3,2h SX/DX ** | 1 | - | 7 | PALLET | 80 x 120 |
| 8,8 mm | | | | | |
| BATTISCOPA 6,5x120 | 6 | - | 11,4 | PALLET | 80 x 120 |
| GRADINO COSTA RETTA 33x120x3,2h ** | 2 | - | 20,7 | PALLET | 80 x 120 |
| GRADINO COSTA RETTA 33x120x3,2h SX/DX ** | 1 | - | 10,8 | PALLET | 80 x 120 |

**** A disposizione solo su richiesta. Tempi di consegna: 30gg**
Available upon request only. Delivery terms: 30 days
Disponible seulement sur requête. Délais de livraison: 30 jours
Verfügbar auf Anfrage. Lieferzeit: 30 Tage



WINE BAR CLUB

Breccia Sicilia

MARMO E PIETRA



Gres Porcellanato. Porcelain tiles
Grès cérame. Feinsteinzeug
ISO 13006 - G - Bla_E ≤ 0,5%
UNI EN 14411

ANSI A - 326.3: 2021
W E T D Y N A M I C
COEFFICIENT OF FRICTION

DCOF ≥ 0,42 | naturale

6 mm



120x280
48"x110"
* Nat Ret
Lap Ret

8,8 mm



60x120
24"x48"
* Nat Ret **R10A**
Lap Ret

* **Materic Touch per la superficie naturale**
Materic Touch for Natural surface
Toucher Matériel pour la surface naturelle
Materische Haptik für die natürliche Oberfläche

La struttura e il tono tra i fondi di spessore 6mm e 8,8mm potrebbero presentare differenze.
The structure and shade of the tiles with 6 mm and 8.8 mm thickness could show differences.
La structure et la teinte des carreaux de 6 mm et 8,8 mm d'épaisseur peuvent présenter des différences.
Die Struktur und der Farbton der Fliesen mit einer Dicke von 6 mm und 8,8 mm könnten Unterschiede aufweisen.

Breccia Sicilia

MARMO E PIETRA

NEW SERIES

100% DESIGN AND PRODUCTION OF ITALY

Sviluppo grafico per formato
Pattern by size
Développement graphique par format
Grafischer Entwurf für Format

120x280
6 mm

4

60x120
8,8 mm

20

Sviluppo Grafico

Pattern by size. Développement graphique par format.
Grafischer Entwurf für Format.

120x280 6 mm

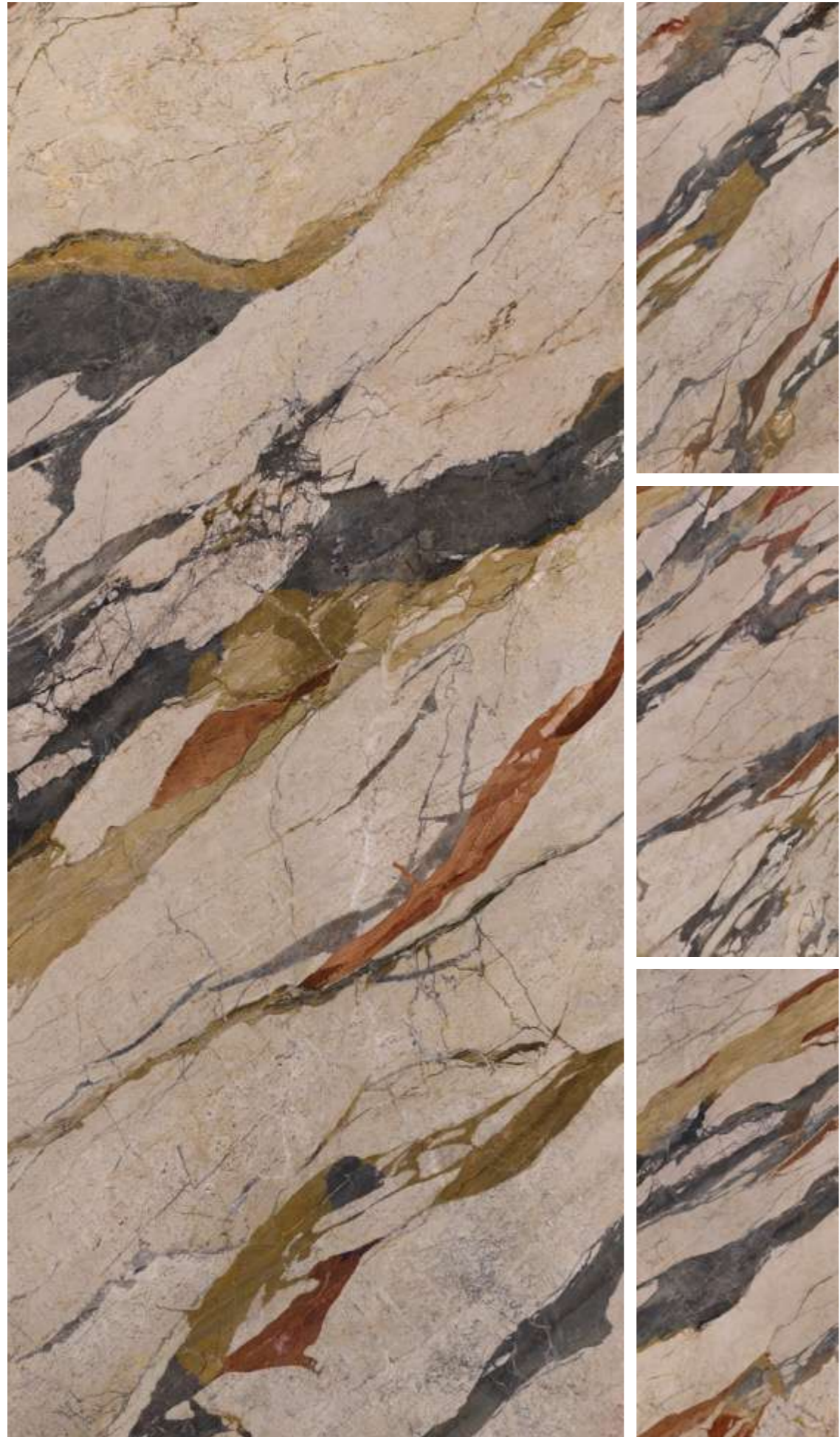

Composizione a vena continua

Continuous vein effect. Composition à nervures continues. Durchgehender marmorierung

COMPOSIZIONE DI 4 LASTRE A VENA CONTINUA FORMATO 120x280 SP 6 MM_63"x126" THK 6 MM
DISPONIBILE CON FINITURA NATURALE RETTIFICATA OPPURE LAPPATA RETTIFICATA

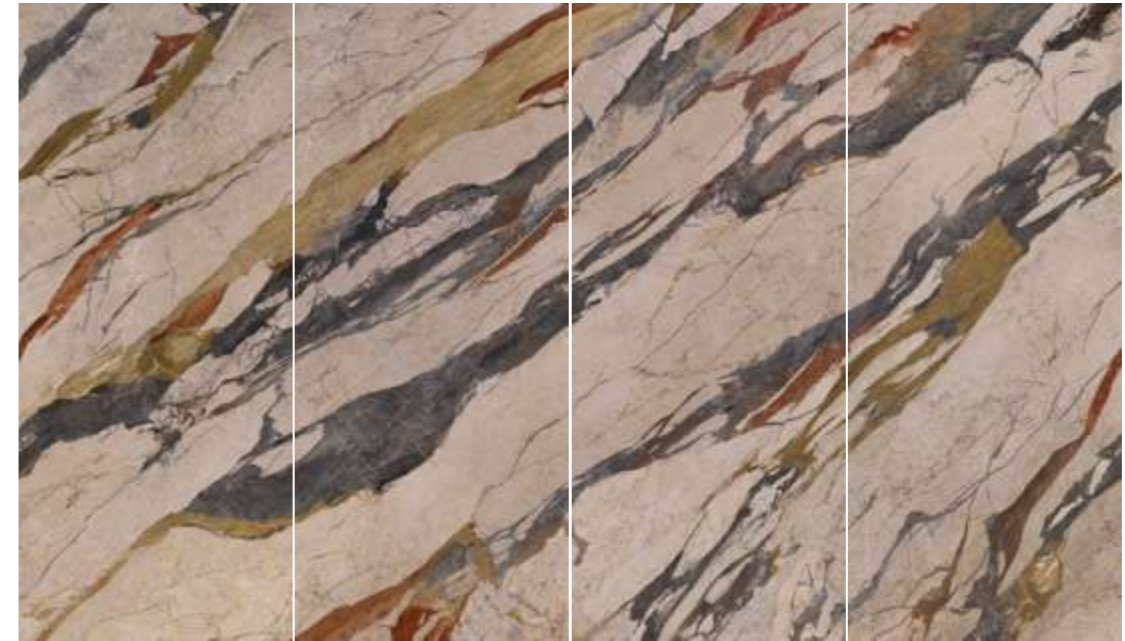

Composition with 4 continuous vein tiles size 120x280 sp 6 mm_48"x110" thk 6 mm available with natural rectified or lapped rectified finish.
Composition de 4 plaques à veines continues format 120x280 ép. 6 mm disponible avec finition naturelle rectifiée ou rodée rectifiée.
Zusammenstellung aus 4 st. Platten mit durchgehender marmorierung, format 120x280, st. 6 mm_48"x110" thk 6 mm verfügbar mit finish natur geschliffen oder geläpft geschliffen.

Le lastre sono fornite con le grafiche **random**. Possono essere fornite con **composizione a vena continua** con una maggiorazione nel prezzo e solo su richiesta esplicita del cliente.

The tiles are supplied with random graphics. They may be supplied with continuous vein effect at an additional charge and only if specifically requested by the customer.

Les plaques sont fournies avec graphiques aléatoires. Elles sont disponibles dans la composition à nervures continues avec une majoration sur le prix et seulement sur demande explicite du client.

Die platten werden mit zufälliger marmorierung geliefert. Sie können auf ausdrücklichen wunsch des kunden gegen aufpreis auch mit einer durchgehenden marmorierung geliefert werden.

Il disegno riprodotto è indicativo. La **grafica di chain** può mostrare discontinuità di vena nel passaggio da una lastra all'altra. Per questo motivo **differenze fino a 3 cm** devono essere considerate come caratteristica del prodotto.

The drawing is purely illustrative. The graphic design of chain may result in discontinuities in the veining between panels. Discontinuities of up to 3 cm are not defects, but are characteristic of the product.

Le dessin reproduit est indicatif. De même que le matériau naturel, le graphisme de chain peut présenter des marbrures discontinues d'une dalle à l'autre. Pour cette raison, les différences jusqu'à 3 cm doivent être considérées comme une caractéristique du produit.

Die wiedergegebene zeichnung ist eine musterzeichnung. Wie für das natürliche material kann auch die grafik von chain brüche der aderungen beim übergang von einer platte zur andern aufweisen. Aus diesem grund sind unterschiede bis zu 3 cm als charakteristik des produkts zu betrachten.

4 PATTERNS

60x120 8,8 mm

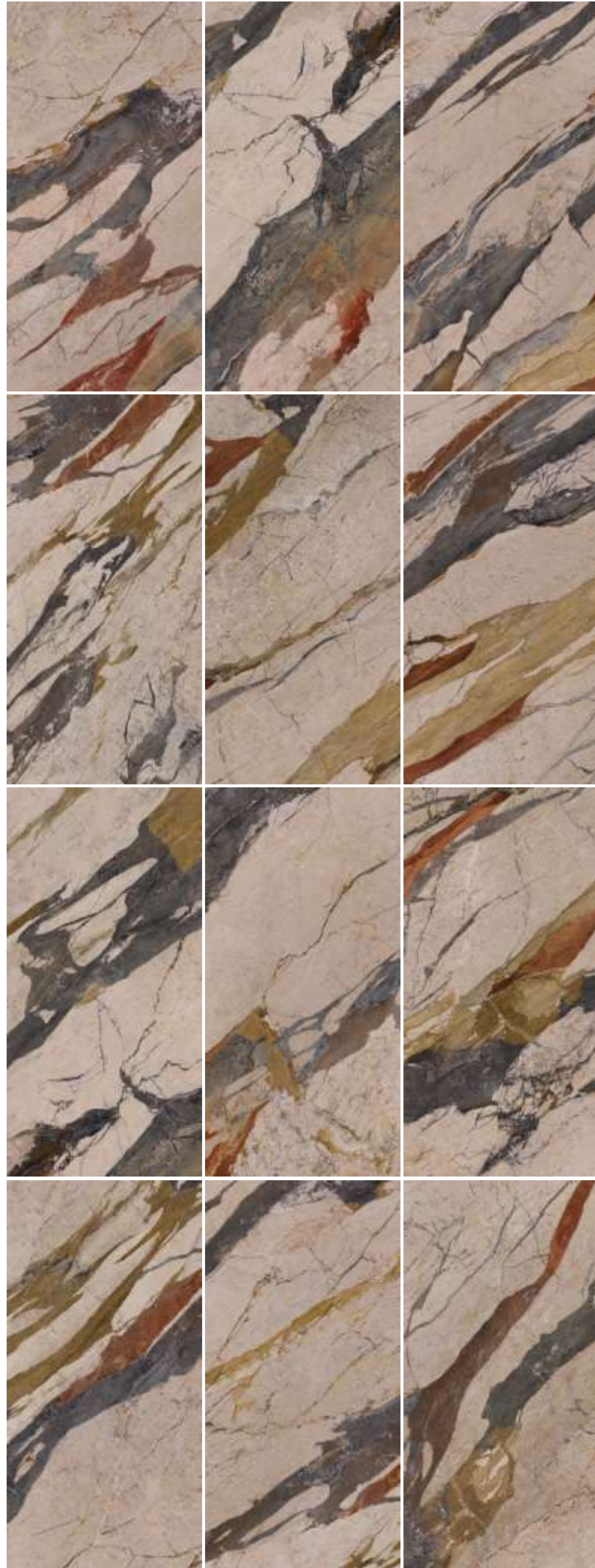

Lo sviluppo grafico mostra solo una selezione dei pattern disponibili. Il numero totale delle grafiche è indicato di seguito.

The graphic development shows only a selection of the available patterns. The total number of patterns is specified below.

Le développement graphique montre uniquement une sélection des motifs disponibles. Le nombre total de motifs est indiqué ci-dessous.

Die grafische Entwicklung zeigt nur eine Auswahl der verfügbaren Muster. Die Gesamtzahl der Muster ist unten angegeben.

20 PATTERNS

Breccia Sicilia

6 mm



120x280
48"x110"

| | * Nat Ret | Lap Ret |
|------------|-----------|---------|
| | 275001 | 275002 |
| Price code | M153 | M175 |

8,8 mm



60x120
24"x48"

| | * Nat Ret R10A | Lap Ret |
|------------|----------------|---------|
| | 275101 | 275102 |
| Price code | M109 | M125 |



* **Materic Touch per la superficie naturale**
Materic Touch for Natural surface
Toucher Matériel pour la surface naturelle
Materische Haptik für die natürliche Oberfläche

La struttura e il tono tra i fondi di spessore 6mm e 8,8mm potrebbero presentare differenze.

The structure and shade of the tiles with 6 mm and 8.8 mm thickness could show differences.

La structure et la teinte des carreaux de 6 mm et 8,8 mm d'épaisseur peuvent présenter des différences.

Die Struktur und der Farbton der Fliesen mit einer Dicke von 6 mm und 8,8 mm könnten Unterschiede aufweisen.

Pezzi Speciali / Trims. Pièces speciale. Die Sonderstücke

| 8,8 mm | Battiscopa Skirting 6,5x120 | | Gradino costa retta** Straight-edge stair** 33x120 | | Gradino costa retta SX - DX** Straight-edge step L-R corner** 33x120 | |
|------------|-----------------------------------|---------|--|---------|--|------------------------|
| | Nat Ret R10A | Lap Ret | Nat Ret R10A | Lap Ret | Nat Ret R10A | Lap Ret |
| | 275501 | 275502 | 275601 | 275602 | 275621 SX 275611 DX | 275622 SX 275612 DX |
| Price code | P040 | P043 | P207 | P215 | P231 | P243 |

Calpestio (per la finitura naturale) . Foot traffic (for natural finish)

• BRECCIA SICILIA MEDIUM

Imballi / Packings. Emballage. Verpackung

| | PCS/BOX | MQ/BOX | KG/BOX | PCS/PAL | BOX/PAL | MQ/PAL | KG/PAL | PACKING | PACKING SIZE | TARE (KG) |
|------------------|---------|--------|--------|---------|---------|--------|--------|------------------|-----------------|-----------|
| 6 mm | | | | | | | | | | |
| 120 x 280 | - | - | - | 20 | - | 67,20 | 974 | CASSA | 292 x 145 x 35h | 108 |
| | - | - | - | 44 | - | 147,84 | 2.140 | CAVALLETTO LEGNO | 290 x 75 x 161h | 145 |
| 8,8 mm | | | | | | | | | | |
| 60 x 120 Nat Ret | 2 | 1,44 | 27,8 | - | 32 | 46,08 | 890 | EPAL | 80 x 120 x 75h | 22 |
| 60 x 120 Lap Ret | 2 | 1,44 | 27,8 | - | 30 | 43,20 | 834 | EPAL | 80 x 120 x 75h | 22 |



Cavalletto in legno
Wood A-Frame. Support en bois.
Holzgestell



Cassa
Crate . Caisse . Kiste



Epal/Pallet

| Pezzi Speciali / Trims | PCS/BOX | MQ/BOX | KG/BOX | PACKING | PACKING SIZE |
|---|---------|--------|--------|---------|--------------|
| 8,8 mm | | | | | |
| BATTISCOPIA 6,5 x 120 | 6 | - | 11,4 | PALLET | 80 x 120 |
| GRADINO COSTA RETTA 33 x 120 x 3,2h ** | 2 | - | 20,7 | PALLET | 80 x 120 |
| GRADINO COSTA RETTA 33 x 120 x 3,2h SX/DX** | 1 | - | 10, | PALLET | 80 x 120 |

** A disposizione solo su richiesta. Tempi di consegna: 30gg
Available upon request only. Delivery terms: 30 days
Disponible seulement sur requête. Délais de livraison: 30 jours
Verfügbar auf Anfrage. Lieferzeit: 30 Tage

Bronze Amani

MARMO E PIETRA





Gres Porcellanato. Porcelain tiles
Grès cérame. Feinsteinzeug
ISO 13006 - G - Bla_E ≤ 0,5%
UNI EN 14411

ANSI A - 326.3: 2021
W E T D Y N A M I C
COEFFICIENT OF FRICTION

DCOF ≥ 0,42 | naturale

6 mm



120x280
48"x110"
Lap Ret

8,8 mm



60x120
24"x48"
* Nat Ret **R10A**
Lap Ret

Bronze Amani

MARMO E PIETRA

100% DESIGN AND PRODUCTION OF ITALY

Sviluppo grafico per formato
Pattern by size
Développement graphique par format
Grafischer Entwurf für Format

120x280
6 mm
11

60x120
8,8 mm
24

Sviluppo Grafico

Pattern by size. Développement graphique par format.
Grafischer Entwurf für Format



120x280 6 mm

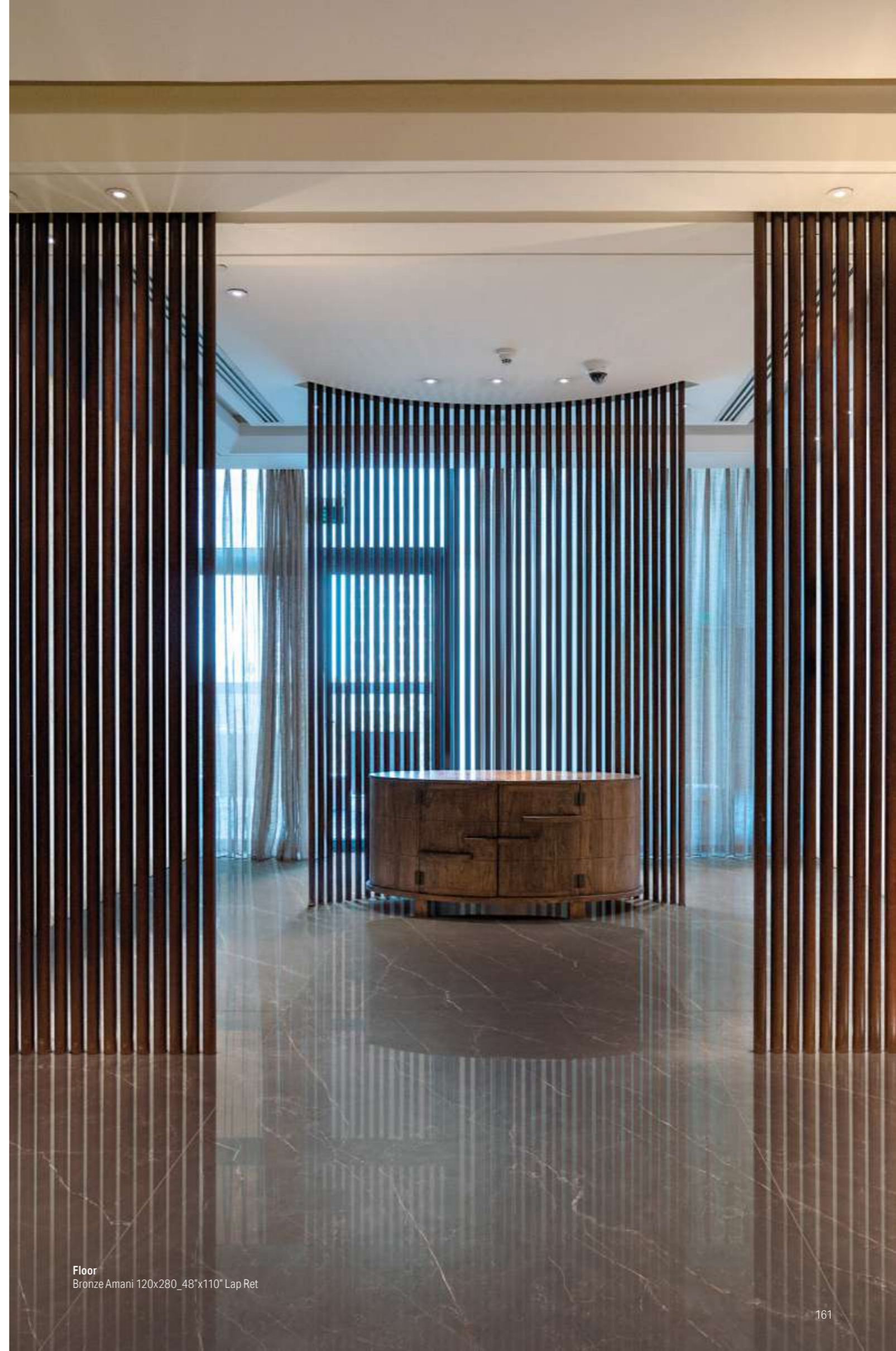

PATTERNS 11



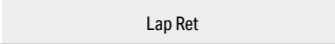

Floor
Bronze Amani 120x280_48"x110" Lap Ret

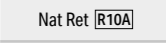
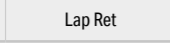
Bronze Amani

| | | |
|---|---|----------------------------|
| 6 mm |  | 120x280 48"x110" |
| |  | Lap Ret |
|  | | 148022 |
| Price code | | M175 |

| | | |
|---|---|--------------------------|
| 8,8 mm |  | 60x120 24"x48" |
| |  | Nat Ret R10A |
| |  | Lap Ret |
|  | | 135071 |
| | | 135070 |
| Price code | M109 | M125 |

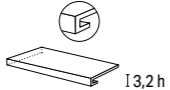
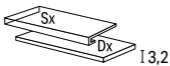
Pezzi Speciali / Trims / Pièces speciale / Die Sonderstücke

| | | | | | | | |
|---------------|---|-------------------------------|---|---|--|---|--------------------------------------|
| 8,8 mm |  | Battiscopa Skirting |  | Gradino costa retta** Straight-edge stair** |  | Gradino costa retta SX - DX** Straight-edge step L-R corner** | |
| | | 6,5x120 | | 33x120 | | 33x120 | |
| |  | Nat Ret R10A | Lap Ret | Nat Ret R10A | Lap Ret | Nat Ret R10A | Lap Ret |
| | | 135211 | 135210 | 135316 | 135346 | 135318 SX 135317 DX | 135348 SX 135347 DX |
| Price code | | P040 | P043 | P207 | P215 | P231 | P243 |

Calpestio (per la finitura naturale) . Foot traffic (for natural finish)

• BRONZE AMANI  **LOW**



Imballi / Packings. Emballage. Verpackung

| | PCS/BOX | MQ/BOX | KG/BOX | PCS/PAL | BOX/PAL | MQ/PAL | KG/PAL | PACKING | PACKING SIZE | TARE (KG) |
|---------------|---------|--------|--------|---------|---------|--------|--------|------------------|-----------------|-----------|
| 6 mm | | | | | | | | | | |
| 120 x 280 | - | - | - | 20 | - | 67,20 | 974 | CASSA | 292 x 145 x 35h | 108 |
| | - | - | - | 44 | - | 147,84 | 2.140 | CAVALLETTO LEGNO | 290 x 75 x 161h | 145 |
| 8,8 mm | | | | | | | | | | |
| 60 x 120 Nat | 2 | 1,44 | 27,4 | - | 32 | 46,08 | 877 | EPAL | 80 x 120 | 22 |
| 60 x 120 Lap | 2 | 1,44 | 27,9 | - | 30 | 43,20 | 837 | EPAL | 80 x 120 | 22 |



Cavalletto in legno
Wood A-Frame. Support en bois.
Holzgestell



Cassa
Crate. Caisse. Kiste



Epal

| PEZZI SPECIALI. TRIMS | PCS/BOX | MQ/BOX | KG/BOX | PACKING | PACKING SIZE |
|--|---------|--------|--------|---------|--------------|
| 8,8 mm | | | | | |
| BATTISCOPA 6,5 x 120 | 6 | - | 11 | EPAL | 80 x 120 |
| GRADINO COSTA RETTA 33 x 120 x 3,2h ** | 2 | - | 23 | EPAL | 80 x 120 |
| GRADINO COSTA RETTA 33 x 120 x 3,2h SX/DX ** | 1 | - | 12 | EPAL | 80 x 120 |

**** A disposizione solo su richiesta.**
Tempi di consegna: 30gg
Available upon request only. Delivery terms: 30 days
Disponible seulement sur requête. Délais de livraison: 30 jours
Verfügbar auf Anfrage. Lieferzeit: 30 Tage



Sahara Noir

MARMO E PIETRA



Gres Porcellanato. Porcelain tiles
Grès cérame. Feinsteinzeug
ISO 13006 - G - Bla_E ≤ 0.5%
UNI EN 14411

ANSI A - 326.3: 2021
W E T D Y N A M I C
COEFFICIENT OF FRICTION

6 mm



120x280
48"x110"
Lap Ret

8,8 mm



60x120
24"x48"
Lap Ret

Sahara Noir

MARMO E PIETRA

100% DESIGN AND PRODUCTION OF ITALY

Sviluppo grafico per formato
Pattern by size
Développement graphique par format
Grafischer Entwurf für Format

120x280
6 mm
4

60x120
8,8 mm
13

Sviluppo Grafico

Pattern by size. Développement graphique par format.
Grafischer Entwurf für Format.

120x280 6 mm



| | | | | | |
|------------|--|---------------------|------------|--|-------------------|
| 6 mm | | 120x280 48"x110" | 8,8 mm | | 60x120 24"x48" |
| | | Lap Ret | | | Lap Ret |
| | | 185004 | | | 135061 |
| Price code | | M181 | Price code | | M133 |

Pezzi Speciali / Trims. Pièces speciale. Die Sonderstücke

| | | | | | | |
|------------|--|-------------------------------|--|---|--|--|
| 8,8 mm | | Battiscopa Skirting | | Gradino costa retta** Straight-edge stair** | | Gradino costa retta SX - DX** Straight-edge step L-R |
| | | 6,5x120 | | 33x120 | | 33x120 |
| | | Lap Ret | | Lap Ret | | Lap Ret |
| | | 135201 | | 135331 | | 135333 SX 135332 DX |
| Price code | | P043 | | P215 | | P243 |

Imballi / Packings. Emballage. Verpackung

| | PCS/BOX | MQ/BOX | KG/BOX | PCS/PAL | BOX/PAL | MQ/PAL | KG/PAL | PACKING | PACKING SIZE | TARE |
|-----------|---------|--------|--------|---------|---------|--------|--------|------------------|-----------------|------|
| 6 mm | | | | | | | | | | |
| 120 x 280 | - | - | - | 20 | - | 67,20 | 835 | CASSA | 292 x 145 x 35h | 108 |
| | - | - | - | 44 | - | 147,84 | 2.060 | CAVALLETTO LEGNO | 290 x 75 x 161h | 145 |
| 8,8 mm | | | | | | | | | | |
| 60 x 120 | 2 | 1,44 | 27,9 | - | 30 | 43,20 | 837 | EPAL | 80 x 120 x 75h | 22 |

| PEZZI SPECIALI. TRIMS | PCS/BOX | MQ/BOX | KG/BOX | PACKING | PACKING SIZE |
|--|---------|--------|--------|---------|--------------|
| 8,8 mm | | | | | |
| BATTISCOPA 6,5 x 120 | 6 | - | 11 | EPAL | 80 x 120 |
| GRADINO COSTA RETTA 33 x 120 x 3,2h ** | 2 | - | 23 | EPAL | 80 x 120 |
| GRADINO COSTA RETTA 33 x 120 x 3,2h SX/DX ** | 1 | - | 12 | EPAL | 80 x 120 |

** A disposizione solo su richiesta.
Tempi di consegna: 30gg
Available upon request only.
Delivery terms: 30 days
Disponible seulement sur requête.
Délais de livraison: 30 jours
Verfügbar auf Anfrage.
Lieferzeit: 30 Tage.



Cavalletto in legno
Wood A-Frame. Support en bois.
Holzgestell



Cassa
Crate . Caisse . Kiste



Pallet speciale con sponde
Special pallet with sides .
Palette spéciale avec bords.
Spezial-Palette mit Wänden.



Epal

4 PATTERNS



Black Gold

MARMO E PIETRA



Gres Porcellanato. Porcelain tiles
Grès cérame. Feinsteinzeug
ISO 13006 - G - Bla_E ≤ 0,5%
UNI EN 14411

ANSI A - 326.3: 2021
W E T D Y N A M I C
COEFFICIENT OF FRICTION

DCOF ≥ 0,42 | naturale

6 mm

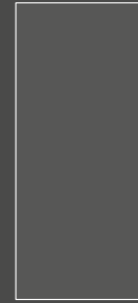

120x280
48"x110"

* Nat Ret
Lap Ret

8,8 mm



60x120
24"x48"

* Nat Ret **R10A**
Lap Ret

* **Materic Touch per la superficie naturale**
Materic Touch for Natural surface
Toucher Matériel pour la surface naturelle
Materische Haptik für die natürliche Oberfläche

La struttura e il tono tra i fondi di spessore 6mm e 8,8mm potrebbero presentare differenze.
The structure and shade of the tiles with 6 mm and 8.8 mm thickness could show differences.
La structure et la teinte des carreaux de 6 mm et 8,8 mm d'épaisseur peuvent présenter des différences.
Die Struktur und der Farbton der Fliesen mit einer Dicke von 6 mm und 8,8 mm könnten Unterschiede aufweisen.

Black Gold

MARMO E PIETRA

Sviluppo grafico per formato
Pattern by size
Développement graphique par format
Grafischer Entwurf für Format

120x280
6 mm

4

60x120
8,8 mm

14

NEW SERIES

100% DESIGN AND PRODUCTION OF ITALY

Sviluppo Grafico

Pattern by size. Développement graphique par format.
Grafischer Entwurf für Format.

120x280 6 mm

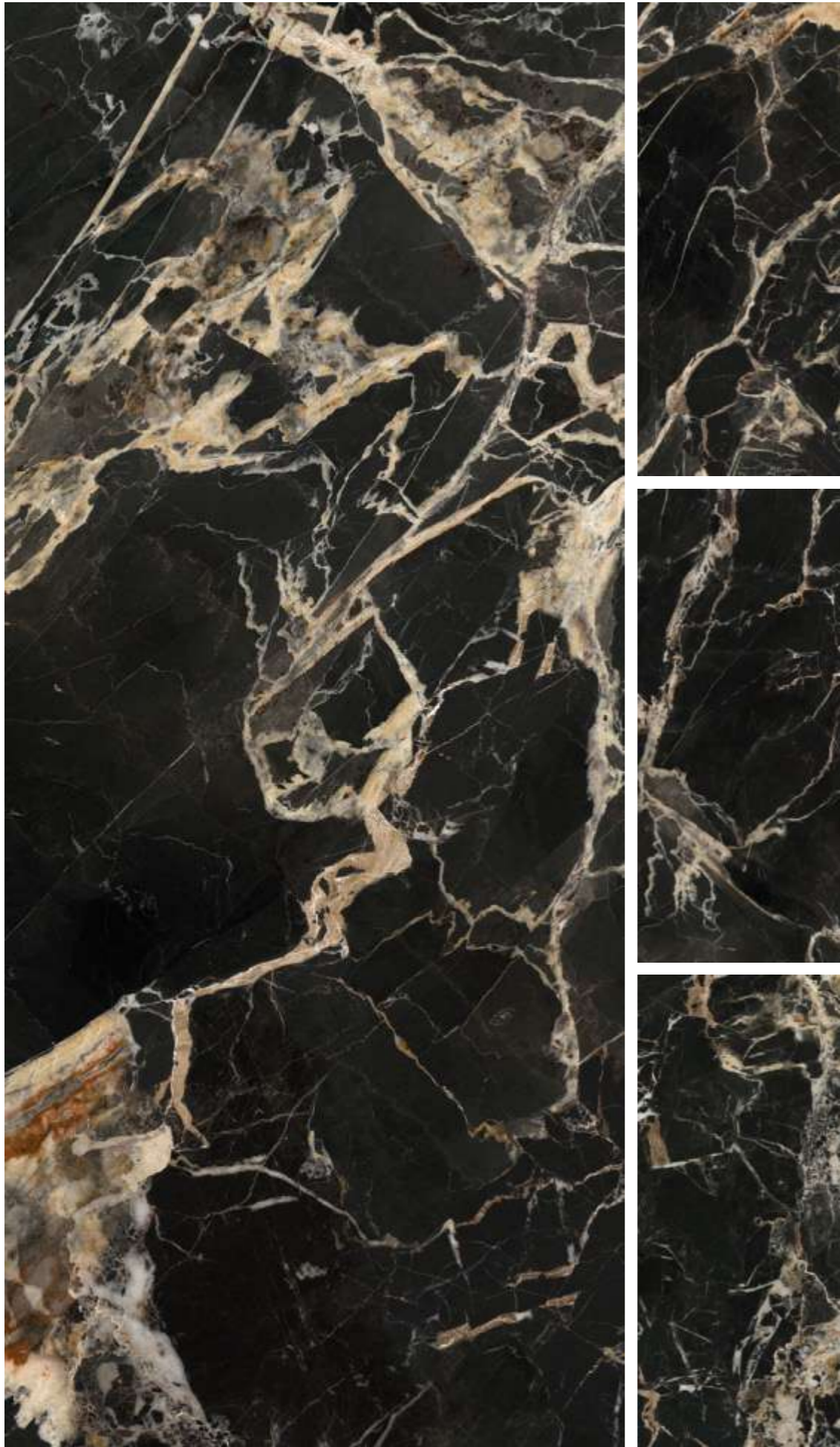

4 PATTERNS

60x120 8,8 mm



14 PATTERNS

Black Gold

6 mm



120x280
48"x110"

| | * Nat Ret | Lap Ret |
|------------|-----------|---------|
| | 276001 | 276002 |
| Price code | M153 | M175 |

8,8 mm



60x120
24"x48"

| | * Nat Ret R10A | Lap Ret |
|------------|-----------------------|---------|
| | 276101 | 276102 |
| Price code | M109 | M125 |



* **Materic Touch per la superficie naturale**
Materic Touch for Natural surface
Toucher Matériel pour la surface naturelle
Materische Haptik für die natürliche Oberfläche

La struttura e il tono tra i fondi di spessore 6mm e 8,8mm potrebbero presentare differenze.
The structure and shade of the tiles with 6 mm and 8.8 mm thickness could show differences.
La structure et la teinte des carreaux de 6 mm et 8,8 mm d'épaisseur peuvent présenter des différences.
Die Struktur und der Farbton der Fliesen mit einer Dicke von 6 mm und 8,8 mm könnten Unterschiede aufweisen.

Pezzi Speciali / Trims. Pièces speciale. Die Sonderstücke

8,8 mm



Battiscopa
Skirting
6,5x120



Gradino costa retta**
Straight-edge stair**
13,2 h

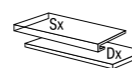

Gradino costa retta SX - DX**
Straight-edge step L-R corner**
13,2 h

| | 6,5x120 | | 33x120 | | 33x120 | |
|------------|---------------------|---------|---------------------|---------|------------------------|------------------------|
| | Nat Ret R10A | Lap Ret | Nat Ret R10A | Lap Ret | Nat Ret R10A | Lap Ret |
| | 276501 | 276502 | 276601 | 276602 | 276621 SX 276611 DX | 276622 SX 276612 DX |
| Price code | P040 | P043 | P207 | P215 | P231 | P243 |

Calpestio (per la finitura naturale) . Foot traffic (for natural finish)

• BLACK GOLD LOW



Wall
Black Gold 120x280_48"x110" Lap Ret

Imballi / Packings. Emballage. Verpackung

| | PCS/BOX | MQ/BOX | KG/BOX | PCS/PAL | BOX/PAL | MQ/PAL | KG/PAL | PACKING | PACKING SIZE | TARE (KG) |
|------------------|---------|--------|--------|---------|---------|--------|--------|------------------|-----------------|-----------|
| 6 mm | | | | | | | | | | |
| 120 x 280 | - | - | - | 20 | - | 67,20 | 974 | CASSA | 292 x 145 x 35h | 108 |
| | - | - | - | 44 | - | 147,84 | 2.140 | CAVALLETTO LEGNO | 290 x 75 x 161h | 145 |
| 8,8 mm | | | | | | | | | | |
| 60 x 120 Nat Ret | 2 | 1,44 | 27,8 | - | 32 | 46,08 | 890 | EPAL | 80 x 120 x 75h | 22 |
| 60 x 120 Lap Ret | 2 | 1,44 | 27,8 | - | 30 | 43,20 | 834 | EPAL | 80 x 120 x 75h | 22 |



Cavalletto in legno
Wood A-Frame.
Support en bois.
Holzgestell



Cassa
Crate . Caisse . Kiste



Epal/Pallet

| Pezzi Speciali / Trims | PCS/BOX | MQ/BOX | KG/BOX | PACKING | PACKING SIZE |
|---|---------|--------|--------|---------|--------------|
| 8,8 mm | | | | | |
| BATTISCOPA 6,5 x 120 | 6 | - | 11,4 | PALLET | 80 x 120 |
| GRADINO COSTA RETTA 33 x 120 x 3,2h ** | 2 | - | 20,7 | PALLET | 80 x 120 |
| GRADINO COSTA RETTA 33 x 120 x 3,2h SX/DX** | 1 | - | 10,8 | PALLET | 80 x 120 |

** A disposizione solo su richiesta. Tempi di consegna: 30gg
Available upon request only. Delivery terms: 30 days
Disponible seulement sur requête. Délais de livraison: 30 jours
Verfügbar auf Anfrage. Lieferzeit: 30 Tage

Deep Stone

MARMO E PIETRA



BLUE

WHITE

BEIGE

NATURAL



Gres Porcellanato. Porcelain tiles
Grès cérame. Feinsteinzeug
ISO 13006 - G - Bla_E ≤ 0,5%
UNI EN 14411

ANSI A - 326.3: 2021
W E T D Y N A M I C
COEFFICIENT OF FRICTION

DCOF ≥ 0,42 | naturale

6 mm



120x280
48"x110"

* Nat Ret
Lap Ret

* **Materic Touch per la superficie naturale**
Materic Touch for Natural surface
Toucher Matériel pour la surface naturelle
Materische Haptik für die natürliche Oberfläche

8,8 mm



60x120
24"x48"

Nat Ret **R10B**
Lap Ret



60x60
24"x24"

Nat Ret **R10B**



30x60
12"x24"

Nat Ret **R10B**

modular system

Decori / Decors



Mosaico 30x30

12"x12"
Nat Ret **R10B**



Stick 30x60

12"x24"
Nat Ret **R10B**



Muretto 30x60

12"x24"
Nat Ret **R10B**

La struttura e il tono tra i fondi di spessore 6mm e 8,8mm potrebbero presentare differenze.
The structure and shade of the tiles with 6 mm and 8.8 mm thickness could show differences.
La structure et la teinte des carreaux de 6 mm et 8,8 mm d'épaisseur peuvent présenter des différences.
Die Struktur und der Farbton der Fliesen mit einer Dicke von 6 mm und 8,8 mm könnten Unterschiede aufweisen.

Deep Stone

MARMO E PIETRA

NEW SERIES

100% DESIGN AND PRODUCTION OF ITALY

Sviluppo grafico per formato
Pattern by size
Développement graphique par format
Grafischer Entwurf für Format

120x280
6 mm
4

60x120
8,8 mm
15

60x60
8,8 mm
30

30x60
8,8 mm
60

Sviluppo Grafico

Pattern by size. Développement graphique par format.
Grafischer Entwurf für Format.

BEIGE 120x280 6 mm



4 PATTERNS

BEIGE 60x120 8,8 mm



Lo sviluppo grafico mostra solo una selezione dei pattern disponibili. Il numero totale delle grafiche è indicato di seguito.

The graphic development shows only a selection of the available patterns. The total number of patterns is specified below.

Le développement graphique montre uniquement une sélection des motifs disponibles. Le nombre total de motifs est indiqué ci-dessous.

Die grafische Entwicklung zeigt nur eine Auswahl der verfügbaren Muster. Die Gesamtzahl der Muster ist unten angegeben.

15 PATTERNS

Deep Stone

6 mm



120x280
48"x110"

| | * Nat Ret | Lap Ret |
|------------|-----------|---------|
| BLUE | 204013 | 204018 |
| WHITE | 204012 | 204017 |
| BEIGE | 204014 | 204019 |
| NATURAL | 204011 | 204016 |
| Price code | M153 | M175 |

8,8 mm

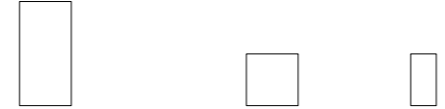

| | Nat Ret R10B | Lap Ret | Nat Ret R10B | Nat Ret R10B |
|------------|---------------------|---------|---------------------|---------------------|
| BLUE | 204003 | 204008 | 204033 | 204038 |
| WHITE | 204002 | 204007 | 204032 | 204037 |
| BEIGE | 204004 | 204009 | 204034 | 204039 |
| NATURAL | 204001 | 204006 | 204031 | 204036 |
| Price code | M097 | M125 | M089 | M081 |

8,8 mm

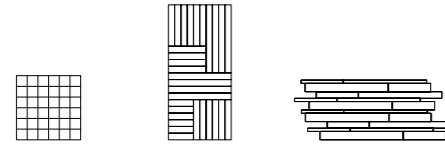

| | Nat Ret R10B | Nat Ret R10B | Nat Ret R10B |
|------------|---------------------|---------------------|---------------------|
| BLUE | 204098 | 204103 | 204108 |
| WHITE | 204097 | 204102 | 204107 |
| BEIGE | 204099 | 204104 | 204109 |
| NATURAL | 204096 | 204101 | 204106 |
| Price code | M159 | M247 | M199 |

* **Materic Touch per la superficie naturale**
Materic Touch for Natural surface
Toucher Matériel pour la surface naturelle
Materische Haptik für die natürliche Oberfläche

La struttura e il tono tra i fondi di spessore 6mm e 8,8mm potrebbero presentare differenze.
The structure and shade of the tiles with 6 mm and 8.8 mm thickness could show differences.
La structure et la teinte des carreaux de 6 mm et 8,8 mm d'épaisseur peuvent présenter des différences.
Die Struktur und der Farbton der Fliesen mit einer Dicke von 6 mm und 8,8 mm könnten Unterschiede aufweisen.

Pezzi Speciali / Trims. Pièces speciale. Die Sonderstücke

8,8 mm

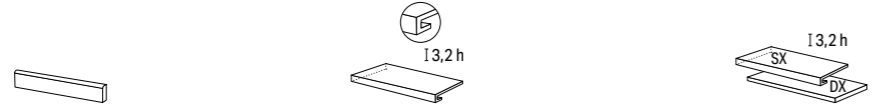

| | 7x60 | 7x60 | 33x120 | | 33x120 | |
|------------|---------------------|---------|---------------------|---------|------------------------|------------------------|
| | Nat Ret R10B | Lap Ret | Nat Ret R10B | Lap Ret | Nat Ret R10B | Lap Ret |
| BLUE | 204078 | 204118 | 204083 | 204123 | 204088 SX 204093 DX | 204128 SX 204133 DX |
| WHITE | 204077 | 204117 | 204082 | 204122 | 204087 SX 204092 DX | 204127 SX 204132 DX |
| BEIGE | 204079 | 204119 | 204084 | 204124 | 204089 SX 204094 DX | 204129 SX 204134 DX |
| NATURAL | 204076 | 204116 | 204081 | 204121 | 204086 SX 204091 DX | 204126 SX 204131 DX |
| Price code | P021 | P025 | P207 | P215 | P231 | P243 |

Calpestio (per la finitura naturale) . Foot traffic (for natural finish)

• BLUE, NATURAL  LOW • WHITE, BEIGE  HIGH



Wall
Beige 30x60_12"x24" Nat Ret

Imballi / Packings. Emballage. Verpackung

| | PCS/BOX | MQ/BOX | KG/BOX | PCS/PAL | BOX/PAL | MQ/PAL | KG/PAL | PACKING | PACKING SIZE | TARE (KG) |
|-----------------------|---------|--------|--------|---------|---------|--------|--------|------------------|-----------------|-----------|
| 6 mm | | | | | | | | | | |
| 120 x 280 | - | - | - | 20 | - | 67,20 | 974 | CASSA | 292 x 145 x 35h | 108 |
| | - | - | - | 44 | - | 147,84 | 2.060 | CAVALLETTO LEGNO | 290 x 75 x 161h | 145 |
| 8,8 mm | | | | | | | | | | |
| 60 x 120 Nat Ret | 2 | 1,44 | 27,7 | - | 32 | 46,08 | 886 | EPAL | 80 x 120 x 75h | 22 |
| 60 x 120 Lap Ret | 2 | 1,44 | 27,9 | - | 30 | 43,20 | 837 | EPAL | 80 x 120 x 75h | 22 |
| 60 x 60 | 3 | 1,08 | 20,8 | - | 40 | 43,20 | 832 | EPAL | 80 x 120 x 75h | 22 |
| 30 x 60 | 7 | 1,26 | 24,6 | - | 48 | 60,48 | 1.181 | EPAL | 80 x 120 x 75h | 22 |
| DECORI. DECORS | | | | | | | | | | |
| MOSAICO 30 x 30 | 6 | 0,54 | 10,3 | - | 60 | 32,40 | 622 | EPAL | 80 x 120 | 22 |
| MURETTO 30 x 60 | 6 | 1,08 | 20,2 | - | 30 | 32,40 | 607 | EPAL | 80 x 120 | 22 |
| STICK 30 x 60 | 6 | 1,08 | 20,2 | - | 30 | 32,40 | 607 | EPAL | 80 x 120 | 22 |



Cavalletto in legno
Wood A-Frame. Support en bois.
Holzgestell



Cassa
Crate . Caisse . Kiste



Epal

| PEZZI SPECIALI. TRIMS | PCS/BOX | MQ/BOX | KG/BOX | PACKING | PACKING SIZE | TARE (KG) |
|--|---------|--------|--------|---------|--------------|-----------|
| 8,8 mm | | | | | | |
| BATTISCOPA 7x60 | 15 | 0,63 | 13,2 | EPAL | 80 x 120 | 22 |
| GRADINO COSTA RETTA 33 x 120 x 3,2h* | 2 | - | 14 | EPAL | 80 x 120 | 22 |
| GRADINO COSTA RETTA 33 x 120 x 3,2h SX/DX* | 1 | - | 7 | EPAL | 80 x 120 | 22 |

* **A disposizione solo su richiesta. Tempi di consegna: 30gg**
Available upon request only. Delivery terms: 30 days
Disponible seulement sur requête. Délais de livraison: 30 jours
Verfügbar auf Anfrage. Lieferzeit: 30 Tage



Noble Stone

MARMO E PIETRA

BEIGE

WHITE

GREY

TAUPE

DARK



Gres Porcellanato. Porcelain tiles
Grès cérame. Feinsteinzeug
ISO 13006 - G - Bla_E ≤ 0,5%
UNI EN 14411

ANSI A - 326.3: 2021
W E T D Y N A M I C
COEFFICIENT OF FRICTION

DCOF ≥ 0,42 | naturale

6 mm

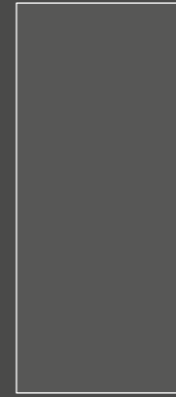

120x280
48"x110"
Nat Ret



120x120
48"x48"
Nat Ret

8,8 mm



100x100
40"x40"
Nat Ret **R10B**



60x120
24"x48"
Nat Ret **R10B**
3D Satin Ret



60x60
24"x24"
Nat Ret **R10B**



30x60
12"x24"
Nat Ret **R10B**

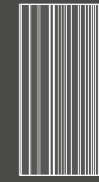

3D Stripes 60x120
24"x48"
Nat Ret **R10B**

modular system

8,8 mm **Decori / Decors**



Mosaico 30x30
12"x12"
Nat Ret **R10B**



Mosaico Modulo
30x30_12"x12"
Nat Ret **R10B**



Basket 29,7x29,7
11 3/4"x11 3/4"
Nat Ret **R10B**



Muretto 30x60
12"x24"
Nat Ret **R10B**

8,8 mm



60x120
24"x48"
Nat Ret **R11C**

Beige
Grey
Taupe

20 mm **OUTDOOR**



60x120
24"x48"
Nat Ret **R11C**

Beige
Grey
Taupe

La struttura e il tono tra i fondi di spessore 6mm e 8,8mm potrebbero presentare differenze.
The structure and shade of the tiles with 6 mm and 8.8 mm thickness could show differences.
La structure et la teinte des carreaux de 6 mm et 8,8 mm d'épaisseur peuvent présenter des différences.
Die Struktur und der Farbton der Fliesen mit einer Dicke von 6 mm und 8,8 mm könnten Unterschiede aufweisen.

Noble Stone

MARMO E PIETRA

100% DESIGN AND PRODUCTION OF ITALY

Sviluppo grafico per formato
Pattern by size
Développement graphique par format
Grafischer Entwurf für Format

120x280
6 mm

4

120x120
6 mm

8

100x100
8,8 mm

12

60x120
8,8 mm

12

60x60
8,8 mm

24

30x60
8,8 mm

48

60x120
20 mm

12

Sviluppo Grafico

Pattern by size. Développement graphique par format.
Grafischer Entwurf für Format

GREY 120x280 6 mm



4 PATTERNS



Wall
Noble Stone Grey 120x280_48"x110" Nat Ret

Counter
Noble Stone Muretto Grey 30x60_12"x24" Nat Ret

Floor
Noble Stone White 100x100_40"x40" Nat Ret

Decori

Decors

8,8 mm R10B

BEIGE



①

WHITE



②

GREY



③

TAUPE

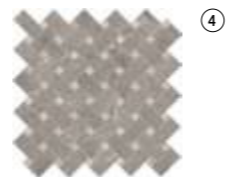
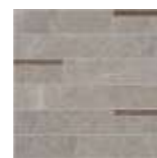

④

DARK

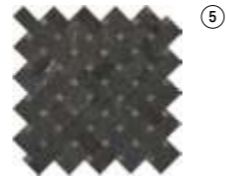

⑤

Mosaico 30x30
12"x12"
Nat Ret

Muretto 30x60 *
12"x24"
Nat Ret

Mosaico Modulo **
30x30_12"x12"
Nat Ret

Basket 29,7x29,7 ***
11 3/4"x11 3/4"
Nat Ret

*DECORO realizzato con inserti in finitura 3D Satin
Decor made with inserts in 3D Satin finishing.
Décor composé d'inserts en finition 3D satinée.
Dekor mit Einsätzen im 3D-Satin-Finish hergestellt.

**DECORO realizzato con la serie Jungle Stone Wild Lap e Noble Stone.
Decor made with Jungle Stone Wild Lap and Noble Stone series.
Décor composé de Jungle Stone Wild Lap et Noble Stone séries.
Dekor mit der Serie Jungle Stone Wild Lap und Noble Stone ausgeführt.

***DECORO realizzato con la serie Ca' Foscari e Noble Stone.
Decoration made with Ca' Foscari and Noble Stone series.
Décor composé de Ca' Foscari et Noble Stone séries.
Dekor mit der Serie Ca' Foscari und Noble Stone ausgeführt.

- ① Ca' Foscari Tabacco / Noble Stone Beige
- ② Ca' Foscari Avana / Noble Stone White
- ③ Ca' Foscari Canapa / Noble Stone Grey
- ④ Ca' Foscari Canapa / Noble Stone Taupe
- ⑤ Ca' Foscari Moro / Noble Stone Dark

3D Stripes

8,8 mm R10B



3D Stripes 60x120
24"x48"
Nat Ret



Noble Stone

| | | | |
|------|---------------------|---------|---------|
| 6 mm | 120x280 48"x110" | Nat Ret | Nat Ret |
| | | BEIGE | 199083 |
| | WHITE | 199081 | 199091 |
| | GREY | 199082 | 199092 |
| | TAUPE | 199085 | 199095 |
| | DARK | 199084 | 199094 |
| | Price code | M153 | M141 |

| | | | | | | |
|--------|--------------------|----------------|----------------|--------------|----------------|----------------|
| 8,8 mm | 100x100 40"x40" | Nat Ret [R10B] | Nat Ret [R10B] | 3D Satin Ret | Nat Ret [R10B] | Nat Ret [R10B] |
| | | BEIGE | 199073 | 199003 | 199023 | 199053 |
| | WHITE | 199071 | 199001 | 199021 | 199051 | 199061 |
| | GREY | 199072 | 199002 | 199022 | 199052 | 199062 |
| | TAUPE | 199075 | 199005 | 199025 | 199055 | 199065 |
| | DARK | 199074 | 199004 | 199024 | 199054 | 199064 |
| | Price code | M109 | M097 | M129 | M089 | M081 |

| | | | | | | | | | | | | |
|--------|---------------------------------|----------------|-----------------------------|-------------------------------|---------------------------------------|--|-------------------|----------------|----------------|----------------|----------------|----------------|
| 8,8 mm | 3D Stripes 60x120 24"x48" | Nat Ret [R10B] | Mosaico 30x30 12"x12" | Muretto 30x60 * 12"x24" | Mosaico Modulo 30x30 ** 12"x12" | Basket 29,7x29,7 *** 11 3/4"x11 3/4" | 60x120 24"x48" | | | | | |
| | | BEIGE | | | | | | Nat Ret [R10B] | Nat Ret [R10B] | Nat Ret [R10B] | Nat Ret [R10B] | Nat Ret [R11C] |
| | | WHITE | | | | | | 199103 | 199123 | 199133 | 199113 | |
| | | GREY | | | | | | 199102 | 199122 | 199132 | 199112 | |
| | | TAUPE | | | | | | 199105 | 199125 | 199135 | 199115 | |
| | | DARK | | | | | | 199104 | 199124 | 199134 | 199114 | |
| | | Price code | | | | | | M111 | M159 | M187 | M199 | M207 |

La struttura e il tono tra i fondi di spessore 6mm e 8,8mm potrebbero presentare differenze.
The structure and shade of the tiles with 6 mm and 8.8 mm thickness could show differences.
La structure et la teinte des carreaux de 6 mm et 8,8 mm d'épaisseur peuvent présenter des différences.
Die Struktur und der Farbton der Fliesen mit einer Dicke von 6 mm und 8,8 mm könnten Unterschiede aufweisen.

Pezzi Speciali / Trims. Pièces speciale. Die Sonderstücke

| | | | |
|-------|-------------------|----------------|--------|
| 20 mm | 60x120 24"x48" | Nat Ret [R11C] | |
| | | BEIGE | 199043 |
| | | WHITE | - |
| | | GREY | 199042 |
| | | TAUPE | 199045 |
| | | DARK | - |
| | | Price code | M131 |

| | | | | | |
|------------|------------------------|----------------|----------------|----------------|------------------------|
| 8,8 mm | Battiscopa Skirting | 7x100 | 7x60 | 33x120 | 33x120 |
| | | Nat Ret [R10B] | Nat Ret [R10B] | Nat Ret [R10B] | Nat Ret [R10B] |
| | BEIGE | 199143 | 199153 | 199163 | 199173 SX 199183 DX |
| | WHITE | 199141 | 199151 | 199161 | 199171 SX 199181 DX |
| | GREY | 199142 | 199152 | 199162 | 199172 SX 199182 DX |
| | TAUPE | 199145 | 199155 | 199165 | 199175 SX 199185 DX |
| | DARK | 199144 | 199154 | 199164 | 199174 SX 199184 DX |
| Price code | P035 | P021 | P207 | P239 | |

| | | | | | | |
|--------|---|----------------|---|----------------|--|--------|
| 8,8 mm | Gradino costa retta**** Straight nosed stair | 33x120 | Gradino costa retta SX - DX**** Straight-edge step L-R | 33x120 | Elemento a "L" incollato**** L-shaped element glued | 33x120 |
| | | Nat Ret [R11C] | Nat Ret [R11C] | Nat Ret [R11C] | | |
| | BEIGE | 199193 | 199203 SX 199213 DX | 199223 | | |
| | WHITE | - | - | - | | |
| | GREY | 199192 | 199202 SX 199212 DX | 199222 | | |
| | TAUPE | 199195 | 199205 SX 199215 DX | 199225 | | |
| | Price code | P207 | P239 | P163 | | |

| | | | |
|-------|------------------------------------|------------------------------|--------|
| 20 mm | Gradone ** Large step 30x120 | Costa toro Nat Ret [R11C] | |
| | | BEIGE | 199413 |
| | | WHITE | - |
| | | GREY | 199412 |
| | | TAUPE | 199415 |
| | | DARK | - |
| | | Price code | P221 |

Calpestio. Foot traffic

- DARK LOW
- GREY, TAUPE MEDIUM
- WHITE, BEIGE HIGH

Imballi / Packings. Emballage. Verpackung

| | PCS/BOX | MQ/BOX | KG/BOX | PCS/PAL | BOX/PAL | MQ/PAL | KG/PAL | PACKING | PACKING SIZE | TARE (KG) |
|---------------------------|---------|--------|--------|---------|---------|--------|--------|-------------------|-----------------|-----------|
| 6 mm | | | | | | | | | | |
| 120 x 280 | - | - | - | 20 | - | 67,20 | 974 | CASSA | 292 x 145 x 35h | 108 |
| 120 x 120 | 2 | 2,88 | 41,8 | 44 | - | 147,84 | 2.060 | CAVALLETTO LEGNO | 290 x 75 x 161h | 145 |
| 8,8 mm | | | | | | | | | | |
| 100 x 100 | 2 | 2 | 36,5 | - | 24 | 48 | 876 | PALLET CON SPONDE | 103 x 123 x 74h | 26 |
| 60 x 120 | 2 | 1,44 | 27,4 | - | 32 | 46,08 | 876 | EPAL | 80 x 120 x 75h | 22 |
| 60 x 120 3D Satin | 2 | 1,44 | 28 | - | 32 | 46,08 | 896 | EPAL | 80 x 120 x 75h | 22 |
| 60 x 120 3D Stripes | 2 | 1,44 | 25,3 | - | 32 | 46,08 | 810 | EPAL | 80 x 120 x 75h | 22 |
| 60 x 120 R11C | 2 | 1,44 | 26,9 | - | 32 | 46,08 | 861 | EPAL | 80 x 120 x 75h | 22 |
| 60 x 60 | 3 | 1,08 | 20,4 | - | 40 | 43,20 | 817 | EPAL | 80 x 120 x 75h | 22 |
| 30 x 60 | 7 | 1,26 | 22,6 | - | 48 | 60,48 | 1.084 | EPAL | 80 x 120 x 75h | 22 |
| DECORI. DECORS | | | | | | | | | | |
| MOSAICO 30 x 30 | 6 | 0,54 | 10,3 | - | 60 | 32,40 | 622 | EPAL | 80 x 120 | 22 |
| MURETTO 30 x 60 * | 6 | 1,08 | 20,2 | - | 30 | 32,40 | 607 | EPAL | 80 x 120 | 22 |
| MOSAICO MODULO 30 x 30 ** | 6 | 0,54 | 10,3 | - | 60 | 32,40 | 622 | EPAL | 80 x 120 | 22 |
| BASKET 29,7 x 29,7 *** | 6 | 0,53 | 10,3 | - | 60 | 31,80 | 622 | EPAL | 80 x 120 | 22 |
| 20 mm | | | | | | | | | | |
| 60 x 120 R11C | 1 | 0,72 | 28 | - | 32 | 23,04 | 896 | EPAL | 80 x 120 | 22 |



Cavalletto in legno
Wood A-Frame. Support en bois. Holzgestell



Cassa
Crate. Caisse. Kiste



Pallet speciale con sponde
Special pallet with sides. Palette spéciale avec bords. Spezial-Palette mit Wandungen.



Epal

| PEZZI SPECIALI. TRIMS | PCS/BOX | MQ/BOX | KG/BOX | PACKING | PACKING SIZE | TARE (KG) |
|--|---------|--------|--------|---------|--------------|-----------|
| 8,8 mm | | | | | | |
| BATTISCOPA 7 x 100 | 6 | 0,4 | 8,10 | EPAL | 80 x 120 | 22 |
| BATTISCOPA 7 x 60 | 15 | 0,6 | 13,28 | EPAL | 80 x 120 | 22 |
| GRADINO COSTA RETTA 33 x 120 x 3,2h **** | 2 | - | 14 | EPAL | 80 x 120 | 22 |
| GRADINO COSTA RETTA 33 x 120 x 3,2h SX/DX **** | 1 | - | 7 | EPAL | 80 x 120 | 22 |
| ELEMENTO A L INCOLLATO **** | 2 | - | 20 | EPAL | 80 x 120 | 22 |

**** A disposizione solo su richiesta. Tempi di consegna: 30gg
Available upon request only. Delivery terms: 30 days
Disponible seulement sur requête. Délais de livraison: 30 jours
Verfügbar auf Anfrage. Lieferzeit: 30 Tage

*** DECORO realizzato con inserti in finitura 3D Satin**
Decor made with inserts in 3D Satin finishing.
Décor composé d'inserts en finition 3D satinée.
Dekor mit Einsätzen im 3D-Satin-Finish hergestellt.

**** DECORO realizzato con la serie Jungle Stone Wild Lap e Noble Stone.**
Decor made with Jungle Stone Wild Lap and Noble Stone series.
Décor composé de Jungle Stone Wild Lap et Noble Stone séries.
Dekor mit der Serie Jungle Stone Wild Lap und Noble Stone ausgeführt.

***** DECORO realizzato con la serie Ca' Foscari e Noble Stone.**
Decoration made with Ca' Foscari and Noble Stone series.
Décor composé de Ca' Foscari et Noble Stone séries.
Dekor mit der Serie Ca' Foscari und Noble Stone ausgeführt.

Bolgheri Stone

MARMO E PIETRA



SAGE

NATURAL

WHITE

BEIGE

6 mm



120x280
48"x110"
Lap Ret

8,8 mm



60x120
24"x48"
Nat Ret **R10B**
Lap Ret
3D Satin Ret



60x60
24"x24"
Nat Ret **R10B**

modular system

Decor / Decors



Mosaico 30x30
12"x12"
Nat Ret



Rombo 37x22
14 1/2"x8 1/2"
Nat Ret



Tex 30x26
12"x10 1/4"
Nat Ret

La struttura e il tono tra i fondi di spessore 6mm e 8,8mm potrebbero presentare differenze.
The structure and shade of the tiles with 6 mm and 8.8 mm thickness could show differences.
La structure et la teinte des carreaux de 6 mm et 8,8 mm d'épaisseur peuvent présenter des différences.
Die Struktur und der Farbton der Fliesen mit einer Dicke von 6 mm und 8,8 mm könnten Unterschiede aufweisen.



Gres Porcellanato. Porcelain tiles
Grès cérame. Feinsteinzeug
ISO 13006 - G - Bla_E ≤ 0,5%
UNI EN 14411

ANSI A - 326.3: 2021
W E T D Y N A M I C
COEFFICIENT OF FRICTION

DCOF ≥ 0,42 | naturale

Bolgheri Stone

MARMO E PIETRA

100% DESIGN AND PRODUCTION OF ITALY

Sviluppo grafico per formato
Pattern by size
Développement graphique par format
Grafischer Entwurf für Format

120x280
6 mm
4

60x120
8,8 mm
11

60x60
8,8 mm
22

Sviluppo Grafico

Pattern by size. Développement graphique par format.
Grafischer Entwurf für Format

NATURAL 120x280 6 mm



Bolgheri Stone

Decori

Decors

8,8 mm R10B

SAGE



NATURAL



WHITE



BEIGE



Rombo 37x22 *
14 1/2"x8 1/2"
Nat Ret

Tex 30x26 *
12"x10 1/4"
Nat Ret

Mosaico 30x30
12"x12"
Nat Ret

4 PATTERNS

* DECORO SAGE, NATURAL, BEIGE realizzato con inserti del colore White.
DECORO WHITE realizzato con inserti del colore Beige.
SAGE, NATURAL, BEIGE DECORATION made with White inserts.
WHITE DECORATION made with Beige inserts.

DÉCORATION SAGE, NATURAL, BEIGE faite d'inserts de la couleur White.
DÉCORATION WHITE faite d'inserts de la couleur Beige.
DEKOR SAGE, NATURAL, BEIGE mit Einlegern in der Farbe White.
DEKOR WHITE mit Einlegern in der Farbe Beige.

Bolgheri Stone

| 6 mm | | 8,8 mm | | | 8,8 mm | | |
|---------------------|--------|-------------------|--------|------------------|--------|-------------------|--------|
| 120x280 48"x110" | | 60x120 24"x48" | | 60x60 24"x24" | | 60x120 24"x48" | |
| Lap Ret | | Nat Ret [R10B] | | Lap Ret | | Nat Ret [R10B] | |
| SAGE | 196043 | SAGE | 196003 | 196013 | 196023 | SAGE | 196017 |
| NATURAL | 196044 | NATURAL | 196004 | 196014 | 196024 | NATURAL | 196018 |
| WHITE | 196041 | WHITE | 196001 | 196011 | 196021 | WHITE | 196015 |
| BEIGE | 196042 | BEIGE | 196002 | 196012 | 196022 | BEIGE | 196016 |
| Price code | M175 | Price code | M109 | M125 | M093 | Price code | M129 |

| 8,8 mm | | 8,8 mm | | 8,8 mm | |
|-----------------------------|--------|-----------------------------------|--------|------------------------------|--------|
| Mosaico 30x30 12"x12" | | Rombo* 37x22 14 1/2"x8 1/2" | | Tex* 30x26 12"x10 1/4" | |
| Nat Ret [R10B] | | Nat Ret [R10B] | | Nat Ret [R10B] | |
| SAGE | 196113 | 196103 | 196093 | SAGE | 196113 |
| NATURAL | 196114 | 196104 | 196094 | NATURAL | 196114 |
| WHITE | 196111 | 196101 | 196091 | WHITE | 196111 |
| BEIGE | 196112 | 196102 | 196092 | BEIGE | 196112 |
| Price code | M159 | M215 | M270 | Price code | M159 |

La struttura e il tono tra i fondi di spessore 6mm e 8,8mm potrebbero presentare differenze.
The structure and shade of the tiles with 6 mm and 8,8 mm thickness could show differences.
La structure et la teinte des carreaux de 6 mm et 8,8 mm d'épaisseur peuvent présenter des différences.
Die Struktur und der Farbton der Fliesen mit einer Dicke von 6 mm und 8,8 mm könnten Unterschiede aufweisen.

*** DECORO SAGE, NATURAL, BEIGE realizzato con inserti del colore White. DECORO WHITE realizzato con inserti del colore Beige.**
SAGE, NATURAL, BEIGE DECORATION made with White inserts.
WHITE DECORATION made with Beige inserts.

DÉCORATION SAGE, NATURAL, BEIGE faite d'inserts de la couleur White.
DÉCORATION WHITE faite d'inserts de la couleur Beige.

DEKOR SAGE, NATURAL, BEIGE mit Einlegern in der Farbe White.
DEKOR WHITE mit Einlegern in der Farbe Beige.

Pezzi Speciali / Trims. Pièces speciale. Die Sonderstücke

| 8,8 mm | | 8,8 mm | | 8,8 mm | |
|--------------------------------|--------|---|--------|--|------------------------|
| Battiscopa Skirting 7x60 | | Gradino costa retta** Straight-edge stair 33x120 | | Gradino costa retta SX - DX** Straight-edge step L-R 33x120 | |
| Nat Ret [R10B] | | Nat Ret [R10B] | | Nat Ret [R10B] | |
| SAGE | 196033 | 196123 | 196053 | 196143 | 196153 SX 196163 DX |
| NATURAL | 196034 | 196124 | 196054 | 196144 | 196064 SX 196074 DX |
| WHITE | 196031 | 196121 | 196051 | 196141 | 196061 SX 196071 DX |
| BEIGE | 196032 | 196122 | 196052 | 196142 | 196062 SX 196072 DX |
| Price code | P021 | P025 | P207 | P215 | P231 P243 |

Calpestio (per la finitura naturale) . Foot traffic (for natural finish)

• SAGE, NATURAL, BEIGE MEDIUM • WHITE HIGH



Wall
Bolgheri Stone Beige 120x280_48"x110" Lap Ret
Bolgheri Stone Tex Beige 30x26_12"x10 1/4" Nat Ret

Floor
Bolgheri Stone Beige 60x120_24"x48" Lap Ret

Imballi / Packings. Emballage. Verpackung

| | PCS/BOX | MQ/BOX | KG/BOX | PCS/PAL | BOX/PAL | MQ/PAL | KG/PAL | PACKING | PACKING SIZE | TARE (KG) |
|-----------------------|---------|--------|--------|---------|---------|--------|--------|------------------|-----------------|-----------|
| 6 mm | | | | | | | | | | |
| 120 x 280 | - | - | - | 20 | - | 67,20 | 974 | CASSA | 292 x 145 x 35h | 108 |
| | - | - | - | 44 | - | 147,84 | 2.060 | CAVALLETTO LEGNO | 290 x 75 x 161h | 145 |
| 8,8 mm | | | | | | | | | | |
| 60 x 120 NAT RET | 2 | 1,44 | 26,4 | - | 32 | 46,08 | 846 | EPAL | 80 x 120 x 75h | 22 |
| 60 x 120 LAP RET | 2 | 1,44 | 27,9 | - | 30 | 43,2 | 837 | EPAL | 80 x 120 x 75h | 22 |
| 60 x 120 3D SATIN RET | 2 | 1,44 | 28 | - | 32 | 46,08 | 896 | EPAL | 80 x 120 x 75h | 22 |
| 60 x 60 | 3 | 1,08 | 20,3 | - | 40 | 43,2 | 814 | EPAL | 80 x 120 x 75h | 22 |
| DECORI. DECORS | | | | | | | | | | |
| MOSAICO 30 x 30 | 6 | 0,54 | 10,4 | 360 | 60 | 32,40 | 622 | EPAL | 80 x 120 | 22 |
| ROMBO 37 x 22* | 6 | 0,49 | 9,7 | 360 | 60 | 29,40 | 585 | EPAL | 80 x 120 | 22 |
| TEX 30 x 26* | 6 | 0,47 | 9,1 | 360 | 60 | 28,20 | 549 | EPAL | 80 x 120 | 22 |



Cavalletto in legno
Wood A-Frame.
Support en bois.
Holzgestell



Cassa
Crate . Caisse . Kiste



Epal

| Pezzi Speciali / Trims | PCS/BOX | MQ/BOX | KG/BOX | PACKING | PACKING SIZE | TARE (KG) |
|---|---------|--------|--------|---------|--------------|-----------|
| 8,8 mm | | | | | | |
| BATTISCOPIA 7 x 60 | 15 | - | 14,7 | EPAL | 80 x 120 | 22 |
| GRADINO COSTA RETTA 33 x 120 x 3,2h** | 2 | - | 23 | EPAL | 80 x 120 | 22 |
| GRADINO COSTA RETTA 33 x 120 x 3,2h SX/DX** | 1 | - | 12 | EPAL | 80 x 120 | 22 |

**** A disposizione solo su richiesta. Tempi di consegna: 30gg**
Available upon request only.
Delivery terms: 30 days
Disponible seulement sur requête.
Délais de livraison: 30 jours
Verfügbar auf Anfrage.
Lieferzeit: 30 Tage.

Mè
BISTROT

Gemstone

MARMO E PIETRA

OCEAN

NATURAL

DESERT

GREY



Gres Porcellanato. Porcelain tiles
Grès cérame. Feinsteinzeug
ISO 13006 - G - Bla_E ≤ 0,5%
UNI EN 14411

ANSI A - 326.3: 2021
W E T D Y N A M I C
COEFFICIENT OF FRICTION

DCOF ≥ 0,42 | naturale

6 mm



120x280
48"x110"
Lap Ret

8,8 mm



60x120
24"x48"
Nat Ret [R10B]
Lap Ret



60x60
24"x24"
Nat Ret [R10B]



30x60
12"x24"
Nat Ret [R10B]

modular system

Decoro / Decor

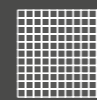

Mosaico 30x30
12"x12"
Nat Ret [R10B]

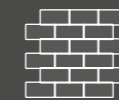

Muretto 30x30
12"x12"
Nat Ret [R10B]

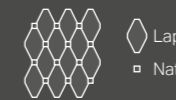

Octagone 30x28
12"x11"
Lap Ret



Rombo 31x31
12 1/4"x12 1/4"
Lap Ret

Gemstone

MARMO E PIETRA

100% DESIGN AND PRODUCTION OF ITALY

| | 120x280 6 mm | 60x120 8,8 mm | 60x60 8,8 mm | 30x60 8,8 mm |
|-------------------------|-----------------|------------------|-----------------|-----------------|
| NATURAL | 3 | 13 | 26 | 52 |
| OCEAN DESERT GREY | 3 | 12 | 24 | 48 |

Sviluppo grafico per formato
Pattern by size
Développement graphique par format
Grafischer Entwurf für Format

Sviluppo Grafico

Pattern by size. Développement graphique par format.
Grafischer Entwurf für Format

OCEAN 120x280 6mm

PATTERNS 3

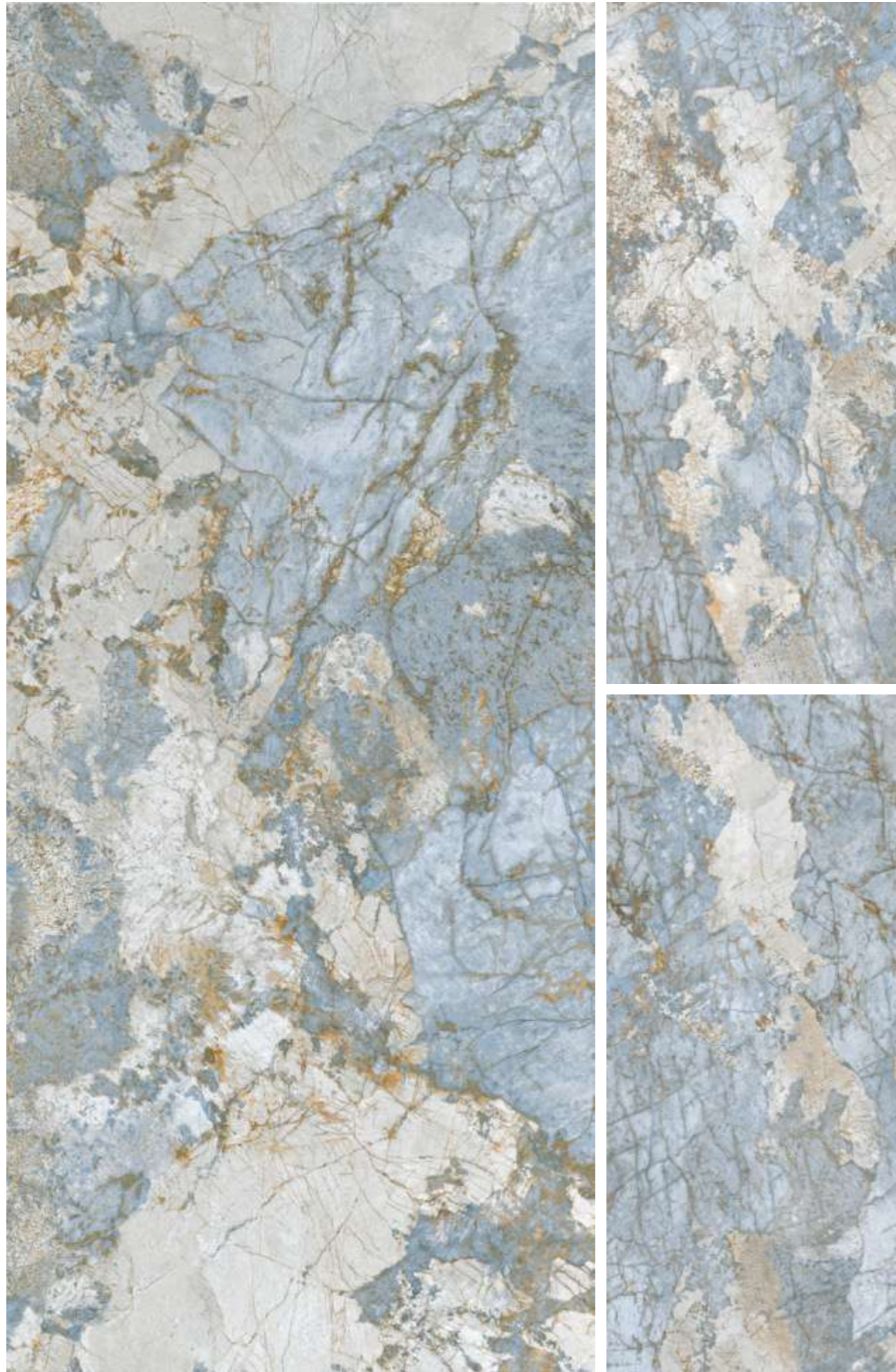

Gemstone

Decori

Decors

8,8mm

OCEAN

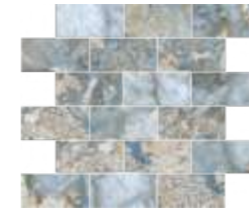
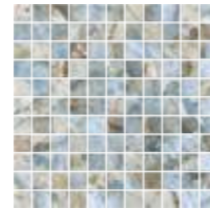

NATURAL

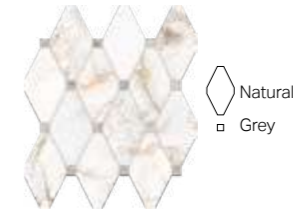

DESERT



GREY

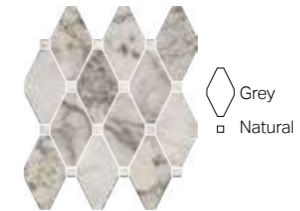
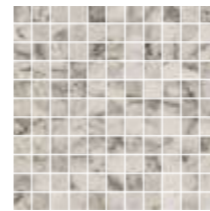

Mosaico 30x30
12"x12"
Nat Ret **[R10B]**

Muretto 30x30
12"x12"
Nat Ret **[R10B]**

Octagone 30x28
12"x11"
Lap Ret

Rombo 31x31
12¼"x12¼"
Lap Ret



Wall
Muretto Grey 30x30_12"x12" Nat Ret

Floor
Natural 60x120_24"x48" Lap Ret

Furniture
Natural 60x120_24"x48" Nat Ret

Gemstone

6 mm



120x280
48"x110"

| | Lap Ret | | |
|------------|---------|--------|--|
| OCEAN | | 179161 | |
| NATURAL | | 179162 | |
| DESERT | | 179163 | |
| GREY | | 179165 | |
| Price code | | M175 | |

8,8 mm



60x120
24"x48"



60x60
24"x24"



30x60
12"x24"

| | Nat Ret [R10B] | Lap Ret | Nat Ret [R10B] | Nat Ret [R10B] |
|------------|----------------|---------|----------------|----------------|
| OCEAN | 179031 | 179071 | 179001 | 179011 |
| NATURAL | 179032 | 179072 | 179002 | 179012 |
| DESERT | 179033 | 179073 | 179003 | 179013 |
| GREY | 179035 | 179075 | 179005 | 179015 |
| Price code | M109 | M125 | M093 | M085 |

8,8 mm



Mosaico
30x30
12"x12"



Muretto
30x30
12"x12"



Octagone
30x28
12"x11"



Rombo
31x31
12 1/4"x12 1/4"

| | Nat Ret [R10B] | Nat Ret [R10B] | Lap Ret | Lap Ret |
|------------|----------------|----------------|---------|---------|
| OCEAN | 179121 | 179131 | 179141 | 179151 |
| NATURAL | 179122 | 179132 | 179142 | 179152 |
| DESERT | 179123 | 179133 | 179143 | 179153 |
| GREY | 179125 | 179135 | 179145 | 179155 |
| Price code | M193 | M181 | M324 | M235 |

Pezzi Speciali / Trims. Pièces speciale. Die Sonderstücke



Battiscopa
Skirting

7x60

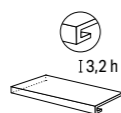

Gradino
costa retta**
Straight-edge stair**

33x120

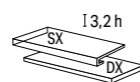

Gradino
costa retta SX - DX**
Straight-edge step L-R

33x120

8,8 mm

| | Nat Ret [R10B] | Lap Ret | Nat Ret [R10B] | Lap Ret | Nat Ret [R10B] | Lap Ret |
|------------|----------------|---------|----------------|---------|------------------------|------------------------|
| OCEAN | 179171 | 179181 | 179201 | 179211 | 179301 SX 179321 DX | 179311 SX 179331 DX |
| NATURAL | 179172 | 179182 | 179202 | 179212 | 179302 SX 179322 DX | 179312 SX 179332 DX |
| DESERT | 179173 | 179183 | 179203 | 179213 | 179303 SX 179323 DX | 179313 SX 179333 DX |
| GREY | 179175 | 179185 | 179205 | 179215 | 179305 SX 179325 DX | 179315 SX 179335 DX |
| Price code | P021 | P025 | P207 | P215 | P231 | P243 |

Calpestio (per la finitura naturale) . Foot traffic (for natural finish)

• OCEAN LOW • GREY MEDIUM • NATURAL, DESERT HIGH



Wall
Desert 30x60_12"x24" Nat Ret
Rombo Desert 31x31_12 1/4"x12 1/4" Lap Ret

Floor
Natural 60x120_24"x48" Lap Ret

Imballi / Packings. Emballage. Verpackung

| | PCS/BOX | MQ/BOX | KG/BOX | PCS/PAL | BOX/PAL | MQ/PAL | KG/PAL | PACKING | PACKING SIZE | TARE (KG) |
|-----------------------|---------|--------|--------|---------|---------|--------|--------|------------------|-----------------|-----------|
| 6 mm | | | | | | | | | | |
| 120 x 280 | - | - | - | 20 | - | 67,20 | 974 | CASSA | 292 x 145 x 35h | 108 |
| | - | - | - | 44 | - | 147,84 | 2.205 | CAVALLETTO LEGNO | 290 x 75 x 161h | 145 |
| 8,8 mm | | | | | | | | | | |
| 60 x 120 Nat | 2 | 1,44 | 27,6 | - | 32 | 46,08 | 884 | EPAL | 80 x 120 x 75h | 22 |
| 60 x 120 Lap | 2 | 1,44 | 27,9 | - | 30 | 43,20 | 837 | EPAL | 80 x 120 x 75h | 22 |
| 60 x 60 | 3 | 1,08 | 20,8 | - | 40 | 43,20 | 833 | EPAL | 80 x 120 x 75h | 22 |
| 30 x 60 | 7 | 1,26 | 24,5 | - | 48 | 60,48 | 1.177 | EPAL | 80 x 120 x 75h | 22 |
| DECORI. DECORS | | | | | | | | | | |
| MOSAICO 30 x 30 | 6 | 0,54 | 12,9 | - | 54 | 29,16 | 702 | EPAL | 80 x 120 | 22 |
| MURETTO 30 x 30 | 6 | 0,54 | 12,9 | - | 54 | 29,16 | 697 | EPAL | 80 x 120 | 22 |
| OCTAGONE 30 x 28 | 6 | 0,50 | 10,5 | - | 54 | 27 | 567 | EPAL | 80 x 120 | 22 |
| ROMBO 31 x 31 | 6 | 0,58 | 11,2 | - | 54 | 31,32 | 605 | EPAL | 80 x 120 | 22 |



Cavalletto in legno
Wood A-Frame
Support en bois
Holzgestell



Cassa
Crate . Caisse . Kiste



Epal

| PEZZI SPECIALI. TRIMS | PCS/BOX | MQ/BOX | KG/BOX | PACKING | PACKING SIZE | TARE (KG) |
|--|---------|--------|--------|---------|--------------|-----------|
| 8,8 mm | | | | | | |
| BATTISCOPA 7 x 60 | 15 | 0,6 | 13,28 | EPAL | 80 x 120 | 22 |
| GRADINO COSTA RETTA 33 x 120 x 3,2h ** | 2 | - | 20,70 | EPAL | 80 x 120 | 22 |
| GRADINO COSTA RETTA 33 x 120 x 3,2h SX/DX ** | 1 | - | 10,80 | EPAL | 80 x 120 | 22 |

** A disposizione solo su richiesta.
Tempi di consegna: 30gg
Available upon request only.
Delivery terms: 30 days
Disponible seulement sur requête.
Délais de livraison: 30 jours
Verfügbar auf Anfrage.
Lieferzeit: 30 Tage.

Imperial

MARMO E PIETRA



ALABASTRINO

TREVI

NAVONA

TIVOLI



Gres Porcellanato. Porcelain tiles
Grès cérame. Feinsteinzeug
ISO 13006 - G - Bla_E ≤ 0,5%
UNI EN 14411

ANSI A - 326.3: 2021
W E T - D Y N A M I C
COEFFICIENT OF FRICTION

DCOF ≥ 0,42 | naturale

8,8 mm



120x120
48"x48"
Nat Ret **R10B**
Lap Ret



60x120
24"x48"
Nat Ret **R10B**
Lap Ret



60x60
24"x24"
Nat Ret **R10B**
Lap Ret



30x60
12"x24"
Nat Ret **R10B**
Lap Ret



10x30
4"x12"
Nat Ret **R10B**
Lap Ret

modular system

Decor / Decors



Mosaico 30x30
12"x12"
Nat Ret **R10B**



Esagona 28x29
11"x11 1/2"
Nat Ret **R10B**



Muretto 30x30
12"x12"
Nat Ret **R10B**



Intreccio 30x30
12"x12"
Nat Ret **R10B**



Spina di pesce 30,5x30,5
12"x12"
Nat Ret **R10B**

Imperial

MARMO E PIETRA

100% DESIGN AND PRODUCTION OF ITALY

Sviluppo grafico per formato
Pattern by size
Développement graphique par format
Grafischer Entwurf für Format

120x120
8,8 mm

10

60x120
8,8 mm

15

60x60
8,8 mm

30

30x60
8,8 mm

53

10x30
8,8 mm

318

Sviluppo Grafico

Pattern by size. Développement graphique par format. Grafischer Entwurf für Format

Imperial

ALABASTRINO 60x120 8,8 mm



Decorì

Decors

8,8 mm

ALABASTRINO

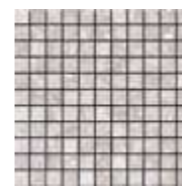

TREVI

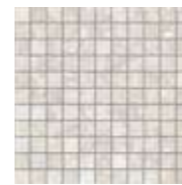

NAVONA



TIVOLI



Mosaico 30x30
12"x12"
Nat Ret R10B

Esagona 28x29
11"x11 1/2"
Nat Ret R10B

Muretto 30x30
12"x12"
Nat Ret R10B

Spina di pesce 30,5x30,5
12"x12"
Nat Ret R10B

Intreccio 30x30
12"x12"
Nat Ret R10B

Lo sviluppo grafico mostra solo una selezione dei pattern disponibili. Il numero totale delle grafiche è indicato di seguito.
The graphic development shows only a selection of the available patterns. The total number of patterns is specified below.
Le développement graphique montre uniquement une sélection des motifs disponibles. Le nombre total de motifs est indiqué ci-dessous.
Die grafische Entwicklung zeigt nur eine Auswahl der verfügbaren Muster. Die Gesamtzahl der Muster ist unten angegeben.

PATTERNS 15

Imperial

8,8 mm

| | 120x120 48"x48" | | 60x120 24"x48" | | 60x60 24"x24" | | 30x60 12"x24" | | 10x30 4"x12" | |
|-------------|--------------------|---------|-------------------|---------|------------------|---------|------------------|---------|-----------------|---------|
| | Nat Ret [R10B] | Lap Ret | Nat Ret [R10B] | Lap Ret | Nat Ret [R10B] | Lap Ret | Nat Ret [R10B] | Lap Ret | Nat Ret [R10B] | Lap Ret |
| ALABASTRINO | 155041 | 155045 | 155001 | 155005 | 155011 | 155015 | 155021 | 155025 | 155031 | 155035 |
| TREVI | 155042 | 155046 | 155002 | 155006 | 155012 | 155016 | 155022 | 155026 | 155032 | 155036 |
| NAVONA | 155043 | 155047 | 155003 | 155007 | 155013 | 155017 | 155023 | 155027 | 155033 | 155037 |
| TIVOLI | 155044 | 155048 | 155004 | 155008 | 155014 | 155018 | 155024 | 155028 | 155034 | 155038 |
| Price code | M121 | M131 | M109 | M121 | M093 | M117 | M085 | M117 | M123 | M139 |

8,8 mm

| | Mosaico 30x30 12"x12" | Esagona 28x29 11"x11 1/2" | Muretto 30x30 12"x12" | Intreccio 30x30 12"x12" | Spina di pesce 30,5x30,5 12"x12" |
|-------------|-----------------------------|---------------------------------|-----------------------------|-------------------------------|--|
| | Nat Ret [R10B] | Nat Ret [R10B] | Nat Ret [R10B] | Nat Ret [R10B] | Nat Ret [R10B] |
| ALABASTRINO | 155331 | 155321 | 155341 | 155311 | 155301 |
| TREVI | 155332 | 155322 | 155342 | 155312 | 155302 |
| NAVONA | 155333 | 155323 | 155343 | - | 155303 |
| TIVOLI | 155334 | 155324 | 155344 | 155314 | 155304 |
| Price code | M193 | M303 | M215 | M211 | M199 |

Pezzi Speciali / Trims. Pièces speciale. Die Sonderstücke

| | Battiscopa Skirting 7x60 | Gradino costa retta** Straight-edge stair** 13,2h 33x120 | Gradino costa retta SX - DX** Straight-edge step L-R 13,2h 33x120 | | |
|-------------|--------------------------------|--|---|------------------------|------------------------|
| | Nat Ret [R10B] | Nat Ret [R10B] | Lap Ret | Nat Ret [R10B] | Lap Ret |
| ALABASTRINO | 155111 | 155201 | 155205 | 155221 SX 155211 DX | 155225 SX 155215 DX |
| TREVI | 155112 | 155202 | 155206 | 155222 SX 155212 DX | 155226 SX 155216 DX |
| NAVONA | 155113 | 155203 | 155207 | 155223 SX 155213 DX | 155227 SX 155217 DX |
| TIVOLI | 155114 | 155204 | 155208 | 155224 SX 155214 DX | 155228 SX 155218 DX |
| Price code | P021 | P207 | P215 | P231 | P243 |

Calpestio (per la finitura naturale) . Foot traffic (for natural finish)

• TIVOLI LOW • ALABASTRINO, NAVONA MEDIUM • TREVI HIGH



Wall
Navona 60x120_24"x48" Nat Ret
Decoro Esagona Navona 28x29_11"x11 1/2" Nat Ret

Floor
Navona 60x120_24"x48" - 60x60_24"x24" Nat Ret

Imballi / Packings. Emballage. Verpackung

| | PCS/BOX | MQ/BOX | KG/BOX | BOX/PAL | MQ/PAL | KG/PAL | PACKING | PACKING SIZE | TARE (KG) |
|--------------------------|---------|--------|--------|---------|--------|--------|---------|----------------|-----------|
| 8,8 mm | | | | | | | | | |
| 120 x 120 | 1 | 1,44 | 28,5 | 40 | 57,60 | 1.140 | PALLET | 122x 137 x 74h | 29 |
| 60 x 120 Nat | 2 | 1,44 | 27,5 | 32 | 46,08 | 880 | EPAL | 80 x 120 x 75h | 22 |
| 60 x 120 Lap | 2 | 1,44 | 33,5 | 30 | 43,20 | 976 | EPAL | 80 x 120 x 75h | 22 |
| 60 x 60 | 3 | 1,08 | 20,3 | 40 | 43,20 | 824 | EPAL | 80 x 120 x 75h | 22 |
| 30 x 60 | 7 | 1,26 | 24,4 | 48 | 60,48 | 1.171 | EPAL | 80 x 120 x 75h | 22 |
| 10 x 30 | 19 | 0,57 | 12,7 | 72 | 41,04 | 914 | EPAL | 80 x 120 x 81h | 22 |
| DECORI. DECORS | | | | | | | | | |
| MOSAICO 30 x 30 | 6 | 0,54 | 10,3 | 60 | 32,40 | 622 | EPAL | 80 x 120 | 22 |
| ESAGONA 28 x 29 | 6 | 0,48 | 9,41 | 60 | 29,23 | 565 | EPAL | 80 x 120 | 22 |
| MURETTO 30 x 30 | 6 | 0,54 | 10,3 | 60 | 32,40 | 622 | EPAL | 80 x 120 | 22 |
| INTRECCIO 30 x 30 | 6 | 0,54 | 10,3 | 60 | 32,40 | 622 | EPAL | 80 x 120 | 22 |
| SPINA DI PESCE 30,5x30,5 | 6 | 0,55 | 10,7 | 60 | 33,48 | 644 | EPAL | 80 x 120 | 22 |

Epal / Pallet

| PEZZI SPECIALI. TRIMS | PCS/BOX | MQ/BOX | KG/BOX | PACKING | PACKING SIZE | TARE (KG) |
|--|---------|--------|--------|---------|--------------|-----------|
| 8,8 mm | | | | | | |
| BATTISCOPA 7 x 60 | 15 | 0,63 | 13,3 | EPAL | 80 x 120 | 22 |
| GRADINO COSTA RETTA 33 x 120 x 3,2h ** | 2 | - | 20,7 | EPAL | 80 x 120 | 22 |
| GRADINO COSTA RETTA 33 x 120 x 3,2h SX/DX ** | 1 | - | 10,8 | EPAL | 80 x 120 | 22 |

**A disposizione solo su richiesta. Tempi di consegna: 30gg.
Available upon request only. Delivery terms: 30 days.
Disponible seulement sur requête. Délais de livraison: 30 jours.
Verfügbar auf Anfrage. Lieferzeit: 30 Tage.



Velaris

MARMO E PIETRA

GRIGIO

BIANCO

BEIGE

BROWN



Gres Porcellanato. Porcelain tiles
Grès cérame. Feinsteinzeug
ISO 13006 - G - Bla_E ≤ 0,5%
UNI EN 14411

ANSI A - 326.3: 2021
W E T - D Y N A M I C
COEFFICIENT OF FRICTION

DCOF ≥ 0,42

6 mm



120x280
48"x110"
Nat Ret

8,8 mm



120x120
48"x48"
Nat Ret **R10B**



60x120
24"x48"
Nat Ret **R10B**



60x60
24"x24"
Nat Ret **R10B**



30x60
12"x24"
Nat Ret **R10B**

modular system

Decori / Decors

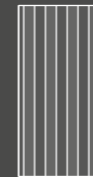

Bianco
Beige

Colonna 60x120
24"x48"
Nat Ret



Mosaico 30x30
12"x12"
Nat Ret **R10B**

Bacchetta di metallo
Metal trim

1x120
7/8"x48"

20 mm OUTDOOR



60x120
24"x48"
Nat Ret **R11C**

La struttura e il tono tra i fondi di spessore 6mm e 8,8mm potrebbero presentare differenze.
The structure and shade of the tiles with 6 mm and 8.8 mm thickness could show differences.
La structure et la teinte des carreaux de 6 mm et 8,8 mm d'épaisseur peuvent présenter des différences.
Die Struktur und der Farbton der Fliesen mit einer Dicke von 6 mm und 8,8 mm könnten Unterschiede aufweisen.

Velaris

MARMO E PIETRA

NEW SERIES

100% DESIGN AND PRODUCTION OF ITALY

Sviluppo grafico per formato
Pattern by size
Développement graphique par format
Grafischer Entwurf für Format

| | | | | | |
|-----------------|-------------------|------------------|-----------------|-----------------|-----------------|
| 120x280 6 mm | 120x120 8,8 mm | 60x120 8,8 mm | 60x60 8,8 mm | 30x60 8,8 mm | 60x120 20 mm |
| 4 | 10 | 21 | 42 | 84 | 21 |

Sviluppo Grafico

Pattern by size. Développement graphique par format.
Grafischer Entwurf für Format

BEIGE 120x280 6 mm



4 PATTERNS

BEIGE 60x120 8,8 mm



21 PATTERNS

Lo sviluppo grafico mostra solo una selezione dei pattern disponibili. Il numero totale delle grafiche è indicato di seguito.

The graphic development shows only a selection of the available patterns. The total number of patterns is specified below.

Le développement graphique montre uniquement une sélection des motifs disponibles. Le nombre total de motifs est indiqué ci-dessous.

Die grafische Entwicklung zeigt nur eine Auswahl der verfügbaren Muster. Die Gesamtzahl der Muster ist unten angegeben.



Wall & Floor
Grigio 60x120_24"x48" Nat Ret



Floor
Beige 60x120_24"x48" Nat Ret R11C

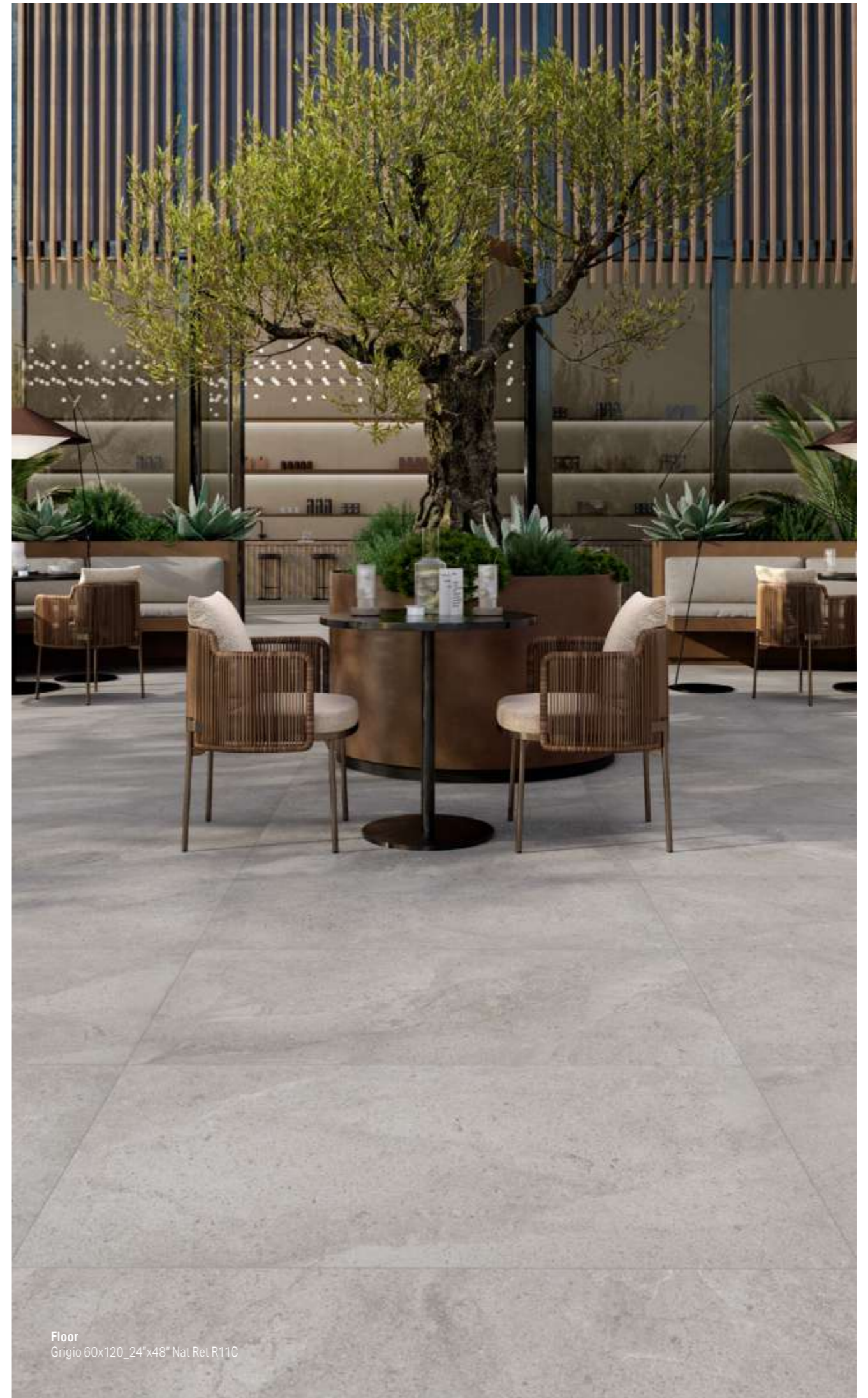

Floor
Grigio 60x120_24"x48" Nat Ret R11C

Velaris

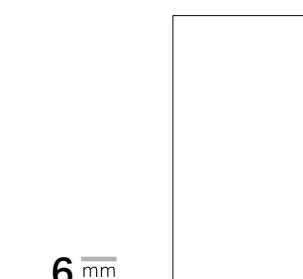

6 mm

120x280
48"x110"

Nat Ret

| | |
|------------|--------|
| BROWN | 263815 |
| GRIGIO | 263814 |
| BIANCO | 263812 |
| BEIGE | 263811 |
| Price code | M153 |

Bacchetta di metallo
Metal trim
1x1x120

| | |
|------------|--------|
| RAME | 263BL5 |
| ORO | 263BL1 |
| SILVER | 263BL4 |
| ACCIAIO | 263BL2 |
| Price code | P050 |

20 mm

60x120
24"x48"

Nat Ret **R11C**

| | |
|------------|--------|
| BROWN | 263425 |
| GRIGIO | 263424 |
| BIANCO | 263422 |
| BEIGE | 263421 |
| Price code | M131 |

Calpestio. Foot traffic

• BROWN LOW • GRIGIO MEDIUM • BIANCO, BEIGE HIGH

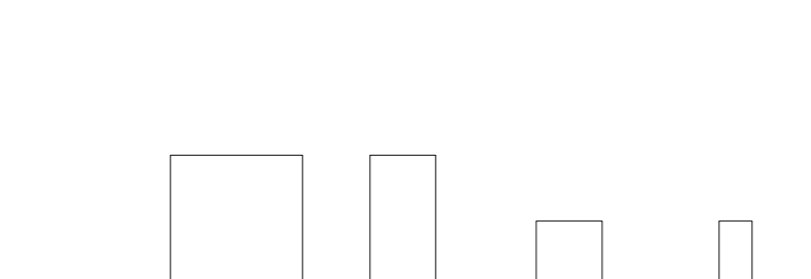

8,8 mm

| | | | | |
|------------|---------------------------|--------------------------|-------------------------|-------------------------|
| | 120x120 48"x48" | 60x120 24"x48" | 60x60 24"x24" | 30x60 12"x24" |
| | Nat Ret R10B | Nat Ret R10B | Nat Ret R10B | Nat Ret R10B |
| BROWN | 263315 | 263115 | 263145 | 263175 |
| GRIGIO | 263314 | 263114 | 263144 | 263174 |
| BIANCO | 263312 | 263112 | 263142 | 263172 |
| BEIGE | 263311 | 263111 | 263141 | 263171 |
| Price code | M118 | M097 | M089 | M081 |

8,8 mm

| | | |
|------------|--|------------------------------------|
| | Colonna 3D 60x120 24"x48" | Mosaico 30x30 12"x12" |
| | Nat Ret | Nat Ret R10B |
| BROWN | - | 2631T5 |
| GRIGIO | - | 2631T4 |
| BIANCO | 2631C2 | 2631T2 |
| BEIGE | 2631C1 | 2631T1 |
| Price code | M111 | M159 |

La struttura e il tono tra i fondi di spessore 6mm e 8,8mm potrebbero presentare differenze.
The structure and shade of the tiles with 6 mm and 8.8 mm thickness could show differences.
La structure et la teinte des carreaux de 6 mm et 8,8 mm d'épaisseur peuvent présenter des différences.
Die Struktur und der Farbton der Fliesen mit einer Dicke von 6 mm und 8,8 mm könnten Unterschiede aufweisen.

Pezzi Speciali / Trims. Pièces speciale. Die Sonderstücke

8,8 mm

| | | | |
|------------|---------------------------------------|--|--|
| | Battiscopa Skirting 7x60 | Gradino costa retta**** Straight nosed stair** 33x120 | Gradino costa retta SX - DX**** Straight-edge step L-R 33x120 |
| | Nat Ret R10B | Nat Ret R10B | Nat Ret R10B |
| BROWN | 263545 | 263615 | 263675 SX 263645 DX |
| GRIGIO | 263544 | 263614 | 263674 SX 263644 DX |
| BIANCO | 263542 | 263612 | 263672 SX 263642 DX |
| BEIGE | 263541 | 263611 | 263671 SX 263641 DX |
| Price code | P021 | P207 | P239 |

20 mm

| | | |
|------------|---|--|
| | Gradone ** Large step 30x120 | Gradone Angolo Sx/ Dx ** Large step - Corner L/R 30x120 |
| | Costa toro Nat Ret R11C | Costa toro Nat Ret R11C |
| BROWN | 263715 | 263775 SX 263745 DX |
| GRIGIO | 263714 | 263774 SX 263744 DX |
| BIANCO | 263712 | 263772 SX 263742 DX |
| BEIGE | 263711 | 263771 SX 263741 DX |
| Price code | P221 | P251 |

Imballi / Packings. Emballage. Verpackung

| | PCS/BOX | MQ/BOX | KG/BOX | BOX/PAL | MQ/PAL | KG/PAL | PACKING | PACKING SIZE | TARE (KG) |
|------------------------------|---------|--------|--------|---------|--------|--------|-------------------|-----------------|-----------|
| 6 mm | | | | | | | | | |
| 120 x 280 | - | - | - | 20 | 67,20 | 974 | CASSA | 292 x 145 x 35h | 108 |
| | - | - | - | 44 | 147,84 | 2.060 | CAVALLETTO LEGNO | 290 x 75 x 161h | 145 |
| 8,8 mm | | | | | | | | | |
| 120 x 120 | 2 | 2,88 | 57,9 | 20 | 57,60 | 1.158 | PALLET | 123x 143 x 74h | 29 |
| 60 x 120 | 2 | 1,44 | 27,4 | 32 | 46,08 | 876 | EPAL | 80 x 120 x 75h | 22 |
| 60 x 60 | 3 | 1,08 | 20,7 | 40 | 43,20 | 828 | EPAL | 80 x 120 x 75h | 22 |
| 30 x 60 | 7 | 1,26 | 24,6 | 48 | 60,48 | 1.181 | EPAL | 80 x 120 x 75h | 22 |
| Colonna 3D 60 x 120 | 2 | 1,44 | 26,5 | 32 | 46,08 | 848 | EPAL | 80 x 120 | 22 |
| Mosaico 30x30 T36 | 6 | 0,54 | 10,4 | 60 | 32,40 | 622 | EPAL | 80 x 120 | 22 |
| BACCHETTA DI METALLO 1 x 120 | 5 | - | 1 | - | - | - | - | - | - |
| 20 mm | | | | | | | | | |
| 60 x 120 R11C | 1 | 0,72 | 32 | 32 | 23,04 | 1.025 | PALLET CON SPONDE | 103 x 123 x 65h | 40 |



Cavalletto in legno
Wood A-Frame
Support en bois
Holzgestell



Cassa
Crate . Caisse . Kiste



Epal



Pallet speciale con sponde
Special pallet with sides

PEZZI SPECIALI. TRIMS

| | PCS/BOX | MQ/BOX | KG/BOX | PACKING | PACKING SIZE | TARE (KG) |
|--|---------|--------|--------|---------|--------------|-----------|
| 8,8 mm | | | | | | |
| BATTISCOPA 7 x 60 | 15 | 0,6 | 13,28 | EPAL | 80 x 120 | 22 |
| GRADINO COSTA RETTA 33 x 120 x 3,2h ** | 2 | - | 20,70 | EPAL | 80 x 120 | 22 |
| GRADINO COSTA RETTA 33 x 120 x 3,2h SX/DX ** | 1 | - | 10,35 | EPAL | 80 x 120 | 22 |
| 20 mm | | | | | | |
| GRADONE 30 x 120 ** | 1 | - | 16 | EPAL | 80 x 120 | |
| GRADONE 30 x 120 SX/DX ** | 1 | - | 16 | EPAL | 80 x 120 | |

**** A disposizione solo su richiesta. Tempi di consegna: 30gg**
Available upon request only.
Delivery terms: 30 days
Disponible seulement sur requête.
Délais de livraison: 30 jours
Verfügbar auf Anfrage.
Lieferzeit: 30 Tage.



Pierres des Châteaux

MARMO E PIETRA

CHENONCEAU

CHAMBORD

CHEVERNY

USSÉ

FONTAINEBLEAU



Gres Porcellanato. Porcelain tiles
Grès cérame. Feinsteinzeug
ISO 13006 - G - Bla_E ≤ 0,5%
UNIEN 14411

ANSI A - 326.3: 2021
W E T - D Y N A M I C
COEFFICIENT OF FRICTION

DCOF ≥ 0,42

8,8 mm



100x100
40"x40"
Nat Ret [R10B]



60x120
24"x48"
Nat Ret [R10B]



60x60
24"x24"
Nat Ret [R10B]



30x60
12"x24"
Nat Ret [R10B]



10x30
4"x12"
Nat Ret [R10B]

modular system

Decori / Decors

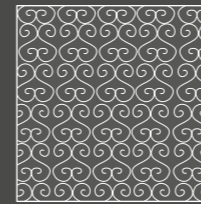

Rose 100x100
40"x40"
Nat Ret [R10B]



Mosaico 30x30
12"x12"
Nat Ret [R10B]



Spina di pesce 30x30
12"x12"
Nat Ret [R10B]



Rete esagonale 30x26
12"x10 1/4"
Nat Ret [R10B]

8,8 mm



100x100
40"x40"
Nat Ret [R11C]

Cheverny
Chambord
Ussé
Fontainebleau

20 mm OUTDOOR



100x100
40"x40"
Nat Ret [R11C]

Formati disponibili con la tecnologia ADVANCE®. Per info consulta pag. 500.

ADVANCE® technology available sizes. For more info go to page 500.

Formats disponibles avec la technologie ADVANCE®. Pour toutes informations aller à la page 500.

Verfügbare Größen mit ADVANCE®-Technologie. Für weitere Infos siehe S. 500.

Pierres des Châteaux

MARMO E PIETRA

100% DESIGN AND PRODUCTION OF ITALY

Sviluppo grafico per formato
Pattern by size
Développement graphique par format
Grafischer Entwurf für Format

100x100
8,8 mm

15

60x120
8,8 mm

30

60x60
8,8 mm

16

30x60
8,8 mm

32

10x30
8,8 mm

190

100x100
20 mm

15

Sviluppo Grafico

Pattern by size. Développement graphique par format. Grafischer Entwurf für Format

FONTAINEBLEAU 60x120 8,8 mm



Lo sviluppo grafico mostra solo una selezione dei pattern disponibili. Il numero totale delle grafiche è indicato di seguito.
The graphic development shows only a selection of the available patterns. The total number of patterns is specified below.
Le développement graphique montre uniquement une sélection des motifs disponibles. Le nombre total de motifs est indiqué ci-dessous.
Die grafische Entwicklung zeigt nur eine Auswahl der verfügbaren Muster. Die Gesamtzahl der Muster ist unten angegeben.

PATTERNS 30

Pierres des Châteaux

Decori 8,8 mm

Decors

CHENONCEAU



Champagne Black *

CHAMBORD



Amarone Brown *

CHEVERNY

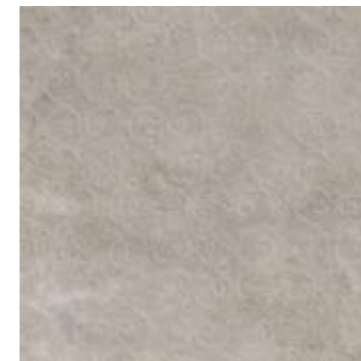

Champagne Grey *

USSÉ

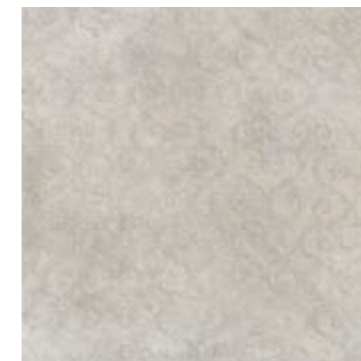

Champagne White *

Pinot grigio White *

FONTAINEBLEAU

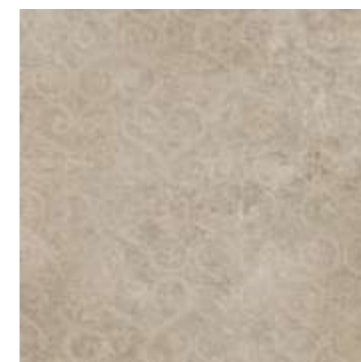

Chardonnay Beige *

Mosaico
30x30_12"x12"
Nat Ret [R10B]

Spina di pesce
30x30_12"x12"
Nat Ret [R10B]

Rete esagonale
30x26_12"x10 1/4"
Nat Ret [R10B]

Rose 100x100_40"x40"
Nat Ret [R10B]

* DECORO realizzato con la serie Pierres des Châteaux e Il Cerreto.
Decoration made with Pierres des Châteaux and Il Cerreto series.
Décor composé de Pierres des Châteaux et Il Cerreto séries.
Dekor mit der Serie Pierres des Châteaux und Il Cerreto ausgeführt.

Pierres des Châteaux

8,8 mm

| | 100x100 40"x40" | 60x120 24"x48" | 60x60 24"x24" | 30x60 12"x24" | 10x30 4"x12" |
|-------------------|-------------------------|-------------------------|-------------------------|-------------------------|---------------------|
| | Nat Ret R10B | Nat Ret R10B | Nat Ret R10B | Nat Ret R10B | Nat Ret R10B |
| CHENONCEAU | 158005 158065 | 158045 158050 | 158015 158020 | 158025 158060 | 158030 |
| CHAMBORD | 158002 158062 | 158042 158047 | 158012 158017 | 158022 158057 | 158027 |
| CHEVERNY | 158001 158061 | 158041 158046 | 158011 158016 | 158021 158056 | 158026 |
| FONTAINEBLEAU | 158004 158064 | 158044 158049 | 158014 158019 | 158024 158059 | 158029 |
| USSÉ | 158003 158063 | 158043 158048 | 158013 158018 | 158023 158058 | 158028 |
| Price code | M109 M128 | M097 M122 | M089 M118 | M081 M110 | M123 |

8,8 mm

| | 100x100 40"x40" | Mosaico 30x30 12"x12" | Spina di pesce 33,5x30 13"x12" | Rete esagonale * 30x26 12"x10 1/4" |
|-------------------|---------------------|-----------------------------|--------------------------------------|--|
| | Nat Ret R10B | Nat Ret R10B | Nat Ret R10B | Nat Ret R10B |
| CHENONCEAU | 158055 | 158305 | 158314 | MOSCP06 |
| CHAMBORD | 158052 | 158302 | 158311 | MOSCP03 |
| CHEVERNY | 158051 | 158301 | 158310 | MOSCP05 |
| FONTAINEBLEAU | 158054 | 158304 | 158313 | MOSCP02 |
| USSÉ | 158053 | 158303 | 158312 | MOSCP04 MOSCP01 |
| Price code | M117 | M159 | M189 | M287 |

Formati disponibili con la tecnologia ADVANCE®.

Per info consulta pag. 500.

ADVANCE® technology available sizes.

For more info go to page 500.

Formats disponibles avec la technologie ADVANCE®.

Pour toutes informations aller à la page 500.

Verfügbare Größen mit ADVANCE®-Technologie.

Für weitere Infos siehe S. 500.

*** DECORO realizzato con le serie
Pierres des Châteaux e Il Cerreto.**

Decorazione made with Pierres des Châteaux
and Il Cerreto series.

Décor composé de Pierres des Châteaux
et Il Cerreto séries.

Dekor mit der Serie Pierres des Châteaux
und Il Cerreto ausgeführt.

8,8 mm

| | 100x100 40"x40" |
|-------------------|---------------------|
| | Nat Ret R11C |
| CHENONCEAU | - |
| CHAMBORD | 158007 |
| CHEVERNY | 158006 |
| FONTAINEBLEAU | 158009 |
| USSÉ | 158008 |
| Price code | M109 |

20 mm

| | 100x100 40"x40" |
|-------------------|---------------------|
| | Nat Ret R11C |
| CHENONCEAU | 158075 |
| CHAMBORD | 158072 |
| CHEVERNY | 158071 |
| FONTAINEBLEAU | 158074 |
| USSÉ | 158073 |
| Price code | M143 |

Calpestio. Foot traffic

• CHENONCEAU LOW • CHAMBORD, CHEVERNY, FONTAINEBLEAU MEDIUM • USSÉ HIGH

Pezzi Speciali / Trims. Pièces speciale. Die Sonderstücke

8,8 mm

| | Battiscopa Skirting | | Gradino costa retta** Straight-edge stair** | | Gradino costa retta SX - DX** Straight-edge step L-R | |
|-------------------|------------------------|---------------------|--|---------------------|---|----------------------------|
| | 7x100 | 7x100 | 7x60 | 7x60 | 33x60 | 33x60 |
| | Nat Ret R10B | Nat Ret R10B | Nat Ret R10B | Nat Ret R10B | Nat Ret R10B | Nat Ret R10B |
| CHENONCEAU | 158105 | 158110 | 158115 | 158120 | 158205 158210 | 158225SX 158215DX 158220DX |
| CHAMBORD | 158102 | 158107 | 158112 | 158117 | 158202 158207 | 158222SX 158212DX 158217DX |
| CHEVERNY | 158101 | 158106 | 158111 | 158116 | 158201 158206 | 158221SX 158211DX 158216DX |
| FONTAINEBLEAU | 158104 | 158109 | 158114 | 158119 | 158204 158209 | 158224SX 158214DX 158219DX |
| USSÉ | 158103 | 158108 | 158113 | 158118 | 158203 158208 | 158223SX 158213DX 158218DX |
| Price code | P035 | P040 | P021 | P025 | P141 P156 | P169 P190 |

20 mm

Gradone costa toro**
Large step

50x100
Nat Ret **R11C**

| | |
|-------------------|-------------|
| CHENONCEAU | 158410 |
| CHAMBORD | 158407 |
| CHEVERNY | 158411 |
| FONTAINEBLEAU | 158409 |
| USSÉ | 158408 |
| Price code | P235 |

La gamma completa dei pezzi speciali è disponibile nella
"PARTE TECNICA" del catalogo a pag. 537

Our entire range of trims is available in our "TECHNICAL SECTION"
of this catalogue pag. 537.

La gamme complète des pièces spéciales est disponible dans
la section "PARTIE TECHNIQUE" à la pag. 537 de ce catalogue.

Das komplette Sortiment an Sonderstücken ist in dem
"technischen Teil" des Katalogs auf Seite 537 verfügbar.

Imballi / Packings. Emballage. Verpackung

| | PCS/BOX | MQ/BOX | KG/BOX | BOX/PAL | MQ/PAL | KG/PAL | PACKING | PACKING SIZE | TARE (KG) | |
|---------------------------------|---------|--------|--------|---------|--------|--------|-------------------|-----------------|-----------|---|
| 8,8 mm | | | | | | | | | | |
| 100 x 100 | 2 | 2,00 | 40 | 24 | 48,00 | 960 | PALLET CON SPONDE | 103 x 123 x 74h | 29 | Pallet speciale con sponde Special pallet with sides . Palette spéciale avec bords. Spezial-Palette mit Wandungen. |
| 100 x 100 R11 | 2 | 2,00 | 40 | 24 | 48,00 | 960 | PALLET CON SPONDE | 103 x 123 x 74h | 29 | |
| 60 x 120 | 2 | 1,44 | 26,8 | 32 | 46,08 | 858 | EPAL | 80 x 120 x 75h | 22 | |
| 60 x 60 | 3 | 1,08 | 20 | 40 | 43,20 | 800 | EPAL | 80 x 120 x 75h | 22 | |
| 30 x 60 | 7 | 1,26 | 24 | 48 | 60,48 | 1.152 | EPAL | 80 x 120 x 75h | 22 | |
| 10 x 30 | 19 | 0,57 | 12 | 72 | 41,04 | 868 | EPAL | 80 x 120 x 81h | 22 | Pallet speciale senza sponde Special pallet without sides . Palette spéciale sans de bords. Spezial-Palette ohne Wandungen. |
| DECORI. DECORS | | | | | | | | | | |
| MOSAICO 30 x 30 | 7 | 0,63 | 13,2 | 60 | 37,80 | 792 | EPAL | 80 x 120 x 81h | 22 | |
| SPINA DI PESCE 33,5 x 30 | 6 | 0,60 | 11,7 | 60 | 36,00 | 703 | EPAL | 80 x 120 x 81h | 22 | |
| RETE ESAGONALE 30x26 | 6 | 0,47 | 10,7 | 60 | 28,20 | 644 | EPAL | 80 x 120 x 75h | 22 | |
| ROSE 100 x 100 | 2 | 2,00 | 40 | 24 | 48,00 | 960 | PALLET CON SPONDE | 103 x 123 x 74h | 29 | |
| 20 mm | | | | | | | | | | |
| 100 x 100 R11 | 1 | 1 | 43,4 | 24 | 24 | 1.041 | PALLET CON SPONDE | 103 x 123 x 65h | 29 | |

PEZZI SPECIALI. TRIMS

| | PCS/BOX | MQ/BOX | KG/BOX | PACKING | PACKING SIZE | TARE (KG) |
|--|---------|--------|--------|---------|--------------|-----------|
| 8,8 mm | | | | | | |
| BATTISCOPA 7 x 100 | 6 | 0,4 | 8,10 | EPAL | 80 x 120 | 22 |
| BATTISCOPA 7 x 60 | 15 | 0,6 | 13,28 | EPAL | 80 x 120 | 22 |
| GRADINO COSTA RETTA 33 x 60 x 3,2h ** | 4 | - | 20,70 | EPAL | 80 x 120 | 22 |
| GRADINO COSTA RETTA 33 x 60 x 3,2h SX/DX** | 2 | - | 10,80 | EPAL | 80 x 120 | 22 |
| 20 mm | | | | | | |
| GRADONE 50 x 100 ** | 1 | - | 15 | PALLET | 103 x 103 | 22 |

** A disposizione solo su richiesta.

Tempi di consegna: 30gg

Available upon request only.

Delivery terms: 30 days

Disponible seulement sur requête.

Délais de livraison: 30 jours

Verfügbar auf Anfrage.

Lieferzeit: 30 Tage



Royal Stone

MARMO E PIETRA



Gres Porcellanato. Porcelain tiles
Grès cérame. Feinsteinzeug
ISO 13006 - G - Bla_E ≤ 0,5%
UNI EN 14411

ANSI A - 326.3: 2021
W E T - D Y N A M I C
COEFFICIENT OF FRICTION

DCOF ≥ 0,42

8,8 mm



100x100
40"x40"
Nat Ret **R10A**



60x120
24"x48"
Nat Ret **R10A**



60x60
24"x24"
Nat Ret **R10A**



30x60
12"x24"
Nat Ret **R10A**



30,5x60,5
12"x24"
Nat **R10A**

modular system

Decoro / Decor



Mosaico 30x30
12"x12"
Nat Ret **R10A**

20 mm OUTDOOR



100x100
40"x40"
Nat Ret **R11C**



60x60
24"x24"
Nat Ret **R11C**

Royal Stone

MARMO E PIETRA

100% DESIGN AND PRODUCTION OF ITALY

Sviluppo grafico per formato
Pattern by size
Développement graphique par format
Grafischer Entwurf für Format

60x120
8,8 mm

60x60
8,8 mm

30x60
8,8 mm

30,5x60,5
8,8 mm

100x100
8,8 mm
20 mm

60x60
20 mm

20

40

78





78

9

40

Royal Stone

8,8 mm

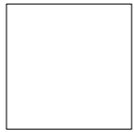

| | | | | | |
|------------|---|---|---|---|---|
| |  |  |  |  |  |
| | 60x120 24"x48" | 60x60 24"x24" | 30x60 12"x24" | 30,5x60,5 12"x24" | 100x100 40"x40" |
| | Nat Ret R10A | Nat Ret R10A | Nat Ret R10A | Nat R10A | Nat Ret R10A |
| GOLD | 122001 | 122005 | 122010 | 122008 | 122012 |
| Price code | M097 | M083 | M081 | M065 | M109 |

8,8 mm

 Mosaico 30x30
12"x12"

| | |
|------------|---------------------|
| | Nat Ret R10A |
| GOLD | 122015 |
| Price code | M135 |

20 mm

| | | |
|------------|---|---|
| |  |  |
| | 100x100 40"x40" | 60x60 24"x24" |
| | Nat Ret R11C | Nat Ret R11C |
| GOLD | 122013 | 122007 |
| Price code | M143 | M117 |

Pezzi Speciali / Trims. Pièces speciale. Die Sonderstücke

8,8 mm

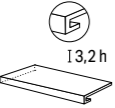
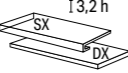
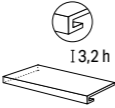
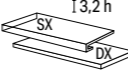
| | | | | | |
|------------|---|---|---|---|---|
| |  |  |  |  |  |
| | Battiscopa Skirting | Gradino costa retta** Straight-edge stair** | Gradino costa retta SX - DX** Straight-edge step L-R | Gradino costa retta** Straight-edge stair** | Gradino costa retta SX - DX** Straight-edge step L-R |
| | 9,5x60 | 33x60 | 33x60 | 33x120 | 33x120 |
| | Nat Ret R10A | Nat Ret R10A | Nat Ret R10A | Nat Ret R10A | Nat Ret R10A |
| GOLD | 122020 | 122030 | 122032 SX 122031 DX | 122033 | 122035 SX 122034 DX |
| Price code | P021 | P135 | P151 | P207 | P231 |



Calpestio. Foot traffic

• GOLD  HIGH

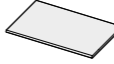
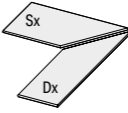

Pezzi Speciali / Trims. Pièces speciale. Die Sonderstücke

20 mm

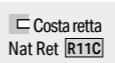
| | | |
|------------|---|---|
| |  |  |
| | Gradone** Large step | Gradone Angolo Sx/Dx** Large step - corner L/R |
| | 30x60 | 30x60 |
| | Costa toro Nat Ret R11C | Costa retta Nat Ret R11C |
| GOLD | 122238 | 122235 |
| Price code | P135 | P135 |

| | | | | |
|------------|---|---|---|---|
| |  |  |  |  |
| | Costa toro Nat Ret R11C | Costa retta Nat Ret R11C | Costa toro Nat Ret R11C | Costa retta Nat Ret R11C |
| GOLD | 122240 SX 122239 DX | 122237 SX 122236 DX | | |
| Price code | P151 | P145 | | |

20 mm

| | | |
|------------|---|---|
| |  |  |
| | Griglia** Drainage grid | Griglia Angolo Sx/Dx** Drainage grid - Corner L/R |
| | 15x60 R11C | 30x60 R11C |
| GOLD | 122226 | 122229 |
| Price code | P195 | P217 |

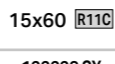
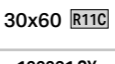
| | | |
|------------|---|---|
| |  |  |
| | 15x60 R11C | 30x60 R11C |
| GOLD | 122228 SX 122227 DX | 122231 SX 122230 DX |
| Price code | P195 | P217 |

La gamma completa dei pezzi speciali è disponibile nella "PARTE TECNICA" del catalogo a pag. 537
Our entire range of trims is available in our "TECHNICAL SECTION" of this catalogue pag. 537.
La gamme complète des pièces spéciales est disponible dans la section "PARTIE TECHNIQUE" à la pag. 537 de ce catalogue.
Das komplette Sortiment an Sonderstücken ist in dem "technischen Teil" des Katalogs auf Seite 537 verfügbar.

Imballi / Packings. Emballage. Verpackung

| | PCS/BOX | MQ/BOX | KG/BOX | BOX/PAL | MQ/PAL | KG/PAL | PACKING | PACKING SIZE |
|-----------------------|---------|--------|--------|---------|--------|--------|-------------------|-----------------|
| 8,8 mm | | | | | | | | |
| 100 x 100 | 2 | 2,00 | 40 | 24 | 48,00 | 990 | PALLET CON SPONDE | 103 x 123 x 70h |
| 60 x 120 | 2 | 1,44 | 29,8 | 32 | 46,08 | 994 | EPAL | 80 x 120 x 75h |
| 60 x 60 | 3 | 1,08 | 22,6 | 40 | 43,20 | 954 | EPAL | 80 x 120 x 75h |
| 30 x 60 | 7 | 1,26 | 24 | 48 | 60,48 | 1.172 | EPAL | 80 x 120 x 75h |
| 30,5 x 60,5 | 7 | 1,29 | 24 | 40 | 51,60 | 979 | EPAL | 80 x 120 x 75h |
| DECORI. DECORS | | | | | | | | |
| MOSAICO 30x30 | 6 | 0,54 | 12,1 | 54 | 23,16 | 676 | EPAL | 80 x 120 x 75h |
| 20 mm | | | | | | | | |
| 100 x 100 | 1 | 1 | 43,8 | 24 | 24 | 1.073 | PALLET CON SPONDE | 103 x 123 x 65h |
| 60 x 60 | 2 | 0,72 | 32 | 32 | 23,04 | 1.046 | EPAL | 80 x 120 x 75h |

 Pallet speciale con sponde
Special pallet with sides.
Palette spéciale avec bords.
Spezial-Palette mit Wandungen.

 Epal / Pallet

| PEZZI SPECIALI. TRIMS | PCS/BOX | MQ/BOX | KG/BOX | PACKING | PACKING SIZE |
|---|---------|--------|--------|---------|--------------|
| 8,8 mm | | | | | |
| BATTISCOPA 9,5 x 60 | 12 | - | 14,50 | EPAL | 80 x 120 |
| GRADINO COSTA RETTA 33 x 60 x 3,2h** | 4 | - | 23,00 | EPAL | 80 x 120 |
| GRADINO COSTA RETTA 33 x 60 x 3,2h SX/DX** | 2 | - | 13,00 | EPAL | 80 x 120 |
| GRADINO COSTA RETTA 33 x 120 x 3,2h** | 2 | - | 23,00 | EPAL | 80 x 120 |
| GRADINO COSTA RETTA 33 x 120 x 3,2h SX/DX** | 1 | - | 12,00 | EPAL | 80 x 120 |
| 20 mm | | | | | |
| GRADONE 15 x 60** | 1 | - | 4,50 | EPAL | 80 x 120 |
| GRADONE 15 x 60 SX/DX** | 1 | - | 3,80 | EPAL | 80 x 120 |
| GRADONE 30 x 60** | 1 | - | 9,00 | EPAL | 80 x 120 |
| GRADONE 30 x 60 SX/DX** | 1 | - | 6,60 | EPAL | 80 x 120 |
| GRIGLIA 15 x 60** | 1 | - | 4,20 | EPAL | 80 x 120 |
| GRIGLIA 15 x 60 SX/DX** | 1 | - | 3,60 | EPAL | 80 x 120 |
| GRIGLIA 30 x 60** | 1 | - | 8,40 | EPAL | 80 x 120 |
| GRIGLIA 30 x 60 SX/DX** | 1 | - | 7,20 | EPAL | 80 x 120 |

** A disposizione solo su richiesta.
Tempi di consegna: 30gg
Available upon request only.
Delivery terms: 30 days
Disponible seulement sur requête. Délais de livraison: 30 jours
Verfügbar auf Anfrage.
Lieferzeit: 30 Tage

La gamma completa dei pezzi speciali è disponibile nella "PARTE TECNICA" del catalogo a pag. 537
Our entire range of trims is available in our "TECHNICAL SECTION" of this catalogue pag. 537.
La gamme complète des pièces spéciales est disponible dans la section "PARTIE TECHNIQUE" à la pag. 537 de ce catalogue.
Das komplette Sortiment an Sonderstücken ist in dem "technischen Teil" des Katalogs auf Seite 537 verfügbar.

Chianca

MARMO E PIETRA



OTRANTO

OSTUNI

CURSI

CARPARO



Gres Porcellanato. Porcelain tiles
Grès cérame. Feinsteinzeug
ISO 13006 - G - Bla_E ≤ 0,5%
UNI EN 14411

ANSI A - 326.3: 2021
W E T D Y N A M I C
COEFFICIENT OF FRICTION

DCOF ≥ 0,42

8,8 mm



60x120
24"x48"
Nat Ret **R10B**



100x100
40"x40"
Nat Ret **R10B**



60,9x60,9
24"x24"
Nat **R10B**



40,6x60,9
16"x24"
Nat **R10B**



40,6x40,6
16"x16"
Nat **R10B**



20,3x40,6
8"x16"
Nat **R10B**



20,3x20,3
8"x8"
Nat **R10B**

Decorì / Decors



Mosaico 30x30
12"x12"
Nat Ret **R10B**



Spaccatella 30x30
12"x12"
Nat Ret **R10B**

modular system

Max 11 mm Min 7 mm



Otranto, Ostuni,
Carparo

Muretto 3D 61x15
24"x6"
Nat

8,8 mm



100x100
40"x40"
Nat Ret **R11C**



60,9x60,9
24"x24"
Nat **R11C**



40,6x60,9
16"x24"
Nat **R11C**



40,6x40,6
16"x16"
Nat **R11C**



20,3x40,6
8"x16"
Nat **R11C**



20,3x20,3
8"x8"
Nat **R11C**

modular system
Ostuni, Curisi

20 mm OUTDOOR



100x100
40"x40"
Nat Ret **R11C**

Chianca

MARMO E PIETRA

100% DESIGN AND PRODUCTION OF ITALY

Sviluppo grafico per formato
Pattern by size
Développement graphique par format
Grafischer Entwurf für Format

| | | | | | | | |
|-------------------|------------------|---------------------|---------------------|---------------------|---------------------|---------------------|------------------|
| 100x100 8,8 mm | 60x120 8,8 mm | 60,9x60,9 8,8 mm | 40,6x60,9 8,8 mm | 20,3x40,6 8,8 mm | 40,6x40,6 8,8 mm | 20,3x20,3 8,8 mm | 100x100 20 mm |
| 8 | 16 | 27 | 27 | 54 | 32 | 54 | 8 |

Sviluppo Grafico

Pattern by size. Développement graphique par format. Grafischer Entwurf für Format

CURSI 60x120 8,8 mm

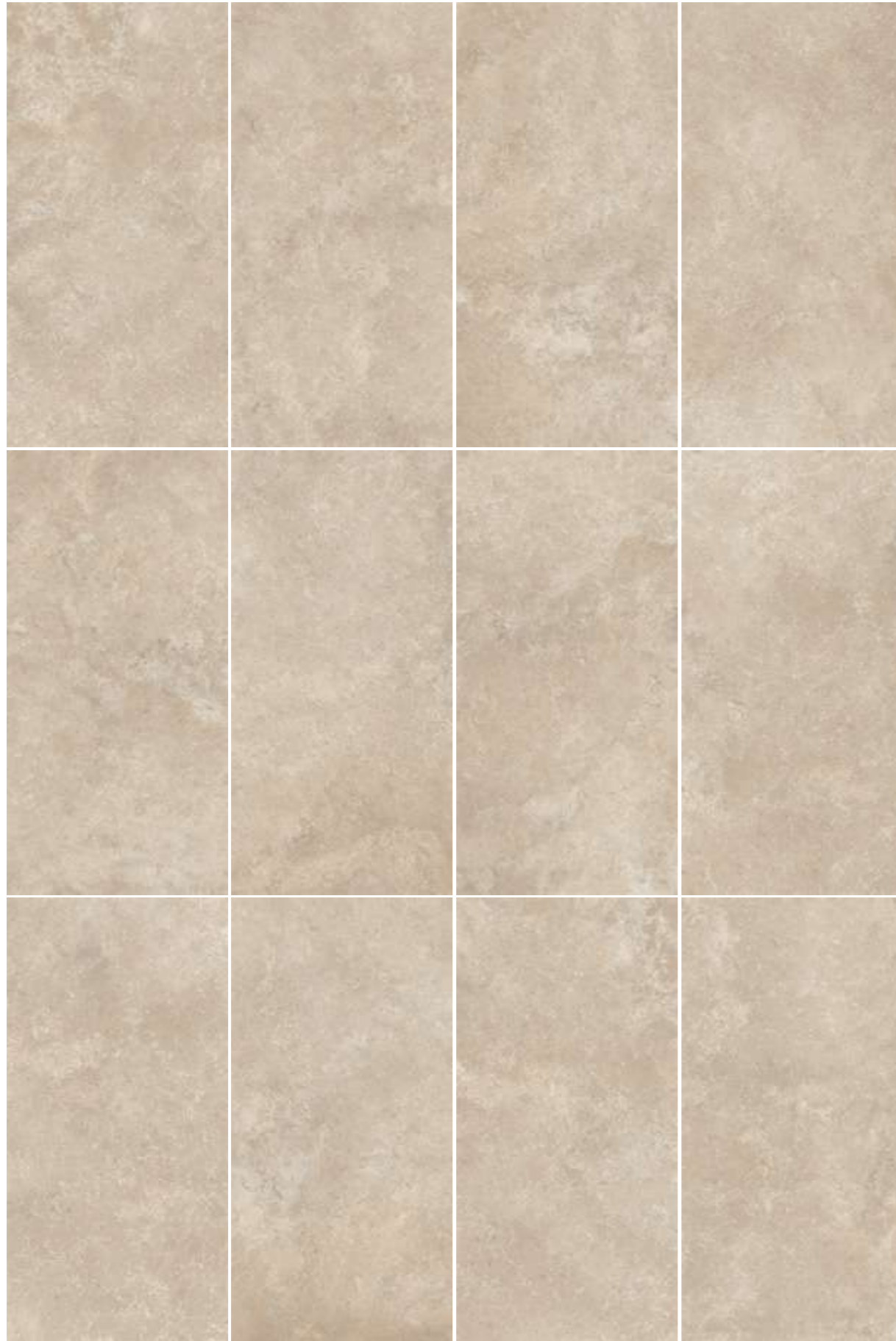

Decori

Decors

8,8 mm

OTRANTO

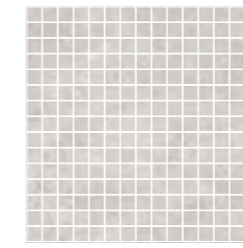
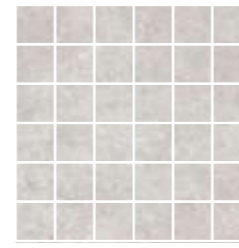

OSTUNI

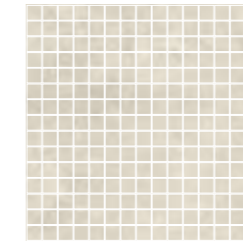

CURSI

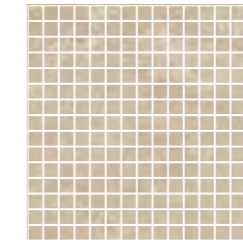
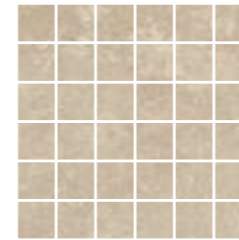

CARPARO

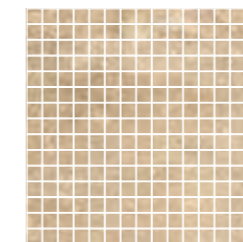
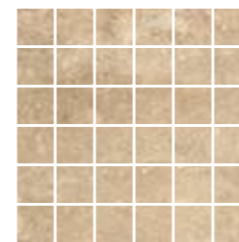

Mosaico 30x30
12"x12"
Nat Ret **R10B**

Spaccatella 30x30
12"x12"
Nat Ret **R10B**

7|11 mm

Max 11 mm Min 7 mm



Muretto 61x15
24"x6"
Nat

Lo sviluppo grafico mostra solo una selezione dei pattern disponibili. Il numero totale delle grafiche è indicato di seguito.
The graphic development shows only a selection of the available patterns. The total number of patterns is specified below.
Le développement graphique montre uniquement une sélection des motifs disponibles. Le nombre total de motifs est indiqué ci-dessous.
Die grafische Entwicklung zeigt nur eine Auswahl der verfügbaren Muster. Die Gesamtzahl der Muster ist unten angegeben.

PATTERNS 16



Wall
Spaccatella Ostuni 30x30_12"x12" Nat Ret

Floor
Ostuni 40,6x60,9_16"x24" - 40,6x40,6_16"x16"
20,3x40,6_8"x16" - 20,3x20,3_8"x8" Nat

Chianca

| 8,8 mm | 100x100 40"x40" | 60x120 24"x48" | 60,9x60,9 24"x24" | 40,6x60,9 12"x24" | 40,6x40,6 16"x16" | 20,3x40,6 8"x16" | 20,3x20,3 8"x8" |
|-------------------|---------------------|---------------------|----------------------|----------------------|----------------------|---------------------|--------------------|
| | Nat Ret R10B | Nat Ret R10B | Nat R10B | Nat R10B | Nat R10B | Nat R10B | Nat R10B |
| OTRANTO | 184064 | 184004 | 184014 | 184024 | 184034 | 184074 | 184084 |
| OSTUNI | 184061 | 184001 | 184011 | 184021 | 184031 | 184071 | 184081 |
| CURSI | 184062 | 184002 | 184012 | 184022 | 184032 | 184072 | 184082 |
| CARPARO | 184063 | 184003 | 184013 | 184023 | 184033 | 184073 | 184083 |
| Price code | M109 | M097 | M083 | M083 | M083 | M083 | M083 |

| 8,8 mm | 100x100 40"x40" | 60,9x60,9 24"x24" | 40,6x60,9 12"x24" | 40,6x40,6 16"x16" | 20,3x40,6 8"x16" | 20,3x20,3 8"x8" | 20 mm | 100x100 40"x40" |
|-------------------|---------------------|----------------------|----------------------|----------------------|---------------------|--------------------|-------------------|---------------------|
| | Nat Ret R11C | Nat R11C | Nat R11C | Nat R11C | Nat R11C | Nat R11C | | Nat Ret R11C |
| OTRANTO | 184054 | - | - | - | - | - | OTRANTO | 184044 |
| OSTUNI | 184051 | 184015 | 184025 | 184035 | 184075 | 184085 | OSTUNI | 184041 |
| CURSI | 184052 | 184016 | 184026 | 184036 | 184076 | 184086 | CURSI | 184042 |
| CARPARO | 184053 | - | - | - | - | - | CARPARO | 184043 |
| Price code | M109 | M083 | M083 | M083 | M083 | M083 | Price code | M143 |

| 8,8 mm | Mosaico 30x30 12"x12" | Spaccatella 30x30 12"x12" | 7,11 mm | Muretto 3D 61x15 24"x6" | Muretto 3D Angolo interno 20x10x15 8"x4"x6" | Muretto 3D Angolo esterno 20x10x15 8"x4"x6" |
|-------------------|-----------------------------|---------------------------------|-------------------|-------------------------------|---|---|
| | Nat Ret R10B | Nat Ret R10B | | Nat | Nat | Nat |
| OTRANTO | 184404 | 184415 | OTRANTO | 184424 | 184434 | 184444 |
| OSTUNI | 184401 | 184411 | OSTUNI | 184421 | 184431 | 184441 |
| CURSI | 184402 | 184412 | CURSI | - | - | - |
| CARPARO | 184403 | 184413 | CARPARO | 184423 | 184433 | 184443 |
| Price code | M159 | M251 | Price code | M083 | P046 | P045 |

Pezzi Speciali / Trims. Pièces speciale. Die Sonderstücke

| 8,8 mm | Battiscopa Skirting | Gradino costa retta** Straight nosed stair** | Gradino costa retta SX - DX** Straight-edge step L-R | |
|-------------------|------------------------------|---|---|-------------------------------|
| | 7x100 Nat Ret R10B | 7x60 Nat Ret R10B | 33x120 Nat Ret R10B | 33x120 Nat Ret R10B |
| OTRANTO | 184114 | 184104 | 184204 | 184224 SX 184214 DX |
| OSTUNI | 184111 | 184101 | 184201 | 184221 SX 184211 DX |
| CURSI | 184112 | 184102 | 184202 | 184222 SX 184212 DX |
| CARPARO | 184113 | 184103 | 184203 | 184223 SX 184213 DX |
| Price code | P035 | P021 | P207 | P231 |

Pezzi Speciali / Trims. Pièces speciale. Die Sonderstücke

| 8,8 mm | Elemento Elle monolitico** L-shaped monoblock tile | 20 mm | Gradone** Large step | Gradone Angolo Sx/Dx** Large step - Corner L/R |
|-------------------|---|-------------------|---|---|
| | 15x30x4 Nat R11C | | 50x100 Costa toro Nat Ret R11C | 50x100 Costa toro Nat Ret R11C |
| OTRANTO | - | OTRANTO | 184244 | 184264 SX 184254 DX |
| OSTUNI | 184231 | OSTUNI | 184241 | 184261 SX 184251 DX |
| CURSI | 184232 | CURSI | 184242 | 184262 SX 184252 DX |
| CARPARO | - | CARPARO | 184243 | 184263 SX 184253 DX |
| Price code | P044 | Price code | P235 | P253 |

La gamma completa dei pezzi speciali è disponibile nella "PARTE TECNICA" del catalogo a pag. 537

Our entire range of trims is available in our "TECHNICAL SECTION" of this catalogue pag. 537.

La gamme complète des pièces spéciales est disponible dans la section "PARTIE TECHNIQUE" à la pag. 537 de ce catalogue.

Das komplette Sortiment an Sonderstücken ist in dem "technischen Teil" des Katalogs auf Seite 537 verfügbar.

Calpestio . Foot traffic

• CURSI, CARPARO MEDIUM • OSTUNI, OTRANTO HIGH

Imballi / Packings. Emballage. Verpackung

| | PCS/BOX | MQ/BOX | KG/BOX | BOX/PAL | MQ/PAL | KG/PAL | PACKING | PACKING SIZE |
|-----------------------|---------|--------|--------|---------|--------|--------|-------------------|-----------------|
| 8,8 mm | | | | | | | | |
| 100 x 100 | 2 | 2 | 37,6 | 24 | 48 | 904 | PALLET CON SPONDE | 103 x 123 x 70h |
| 100 x 100 R11C | 2 | 2 | 37,6 | 24 | 48 | 904 | PALLET CON SPONDE | 103 x 123 x 70h |
| 60 x 120 | 2 | 1,44 | 27,6 | 32 | 46,08 | 853 | EPAL | 80 x 120 x 75h |
| 60,9 x 60,9 | 3 | 1,11 | 21 | 40 | 44,40 | 839 | EPAL | 80 x 120 x 75h |
| 60,9 x 60,9 R11C | 3 | 1,11 | 21 | 40 | 44,40 | 839 | EPAL | 80 x 120 x 75h |
| 40,6 x 60,9 | 6 | 1,48 | 30 | 40 | 59,20 | 1.200 | EPAL | 80 x 120 x 96h |
| 40,6 x 60,9 R11C | 6 | 1,48 | 30 | 40 | 59,20 | 1.200 | EPAL | 80 x 120 x 96h |
| 40,6 x 40,6 | 6 | 0,99 | 17,2 | 72 | 71,28 | 1.238 | EPAL | 80 x 120 x 96h |
| 40,6 x 40,6 R11C | 6 | 0,99 | 17,2 | 72 | 71,28 | 1.238 | EPAL | 80 x 120 x 96h |
| 20,3 x 40,6 | 13 | 1,07 | 18 | 72 | 77,04 | 1.396 | EPAL | 80 x 120 x 96h |
| 20,3 x 40,6 R11C | 13 | 1,07 | 18 | 72 | 77,04 | 1.297 | EPAL | 80 x 120 x 96h |
| 20,3 x 20,3 | 30 | 1,24 | 22 | 60 | 74,40 | 1.297 | EPAL | 80 x 120 x 96h |
| 20,3 x 20,3 R11C | 30 | 1,24 | 22 | 60 | 74,40 | 1.322 | EPAL | 80 x 120 x 96h |
| DECORI. DECORS | | | | | | | | |
| MOSAICO 30 x 30 | 6 | 0,54 | 10,3 | 60 | 32,40 | 622 | EPAL | 80 x 120 |
| SPACCATELLA 30 x 30 | 6 | 0,54 | 10,3 | 60 | 32,40 | 622 | EPAL | 80 x 120 |

| 7,11 mm | | | | | | | | |
|------------------------------------|----|------|-------|----|-------|-----|------|----------|
| DECORI. DECORS | | | | | | | | |
| MURETTO 3D 61x15 | 11 | 1,02 | 19,38 | 48 | 48,96 | 950 | EPAL | 80 x 120 |
| MURETTO 3D ANGOLO INTERNO 20x10x15 | 6 | - | - | 48 | - | - | EPAL | 80 x 120 |
| MURETTO 3D ANGOLO ESTERNO 20x10x15 | 6 | - | - | 48 | - | - | EPAL | 80 x 120 |

| 20 mm | | | | | | | | |
|----------------|---|---|-------|----|----|-------|-------------------|-----------------|
| 100 x 100 R11C | 1 | 1 | 43,27 | 24 | 24 | 1.060 | PALLET CON SPONDE | 103 x 103 x 65h |

| PEZZI SPECIALI. TRIMS | PCS/BOX | MQ/BOX | KG/BOX | PACKING | PACKING SIZE |
|---|---------|--------|--------|---------|--------------|
| 8,8 mm | | | | | |
| BATTISCOPA 7 x 100 | 6 | 0,42 | 8,10 | EPAL | 80 x 120 |
| BATTISCOPA 7 x 60 | 15 | 0,63 | 13,28 | EPAL | 80 x 120 |
| GRADINO COSTA RETTA 33 x 120 x 3,2h ** | 2 | - | 20,70 | EPAL | 80 x 120 |
| GRADINO COSTA RETTA 33 x 120 x 3,2h SX/DX** | 1 | - | 10,80 | EPAL | 80 x 120 |
| ELLE MONOLITICO 15 x 30 x 4h ** | 8 | - | 10,40 | EPAL | 80 x 120 |
| 20 mm | | | | | |
| GRADONE 50 x 100 ** | 1 | - | 15 | PALLET | 103 x 103 |
| GRADONE 50 x 100 SX/DX ** | 1 | - | 15 | PALLET | 103 x 103 |

** A disposizione solo su richiesta.

Tempi di consegna: 30gg

Available upon request only.

Delivery terms: 30 days

Disponible seulement sur requête.

Délais de livraison: 30 jours

Verfügbar auf Anfrage.

Lieferzeit: 30 Tage



Ardesia

MARMO E PIETRA

GRIGIO

CENERE

TAUPE

BIANCO



Gres Porcellanato. Porcelain tiles
Grès cérame. Feinsteinzeug
ISO 13006 - G - Bla_E ≤ 0,5%
UNI EN 14411

ANSI A - 326.3: 2021
W E T D Y N A M I C
COEFFICIENT OF FRICTION

DCOF ≥ 0,42

8,8 mm



60x120
24"x48"
Nat Ret **R10B**



60x60
24"x24"
Nat Ret **R10B**



30x60
12"x24"
Nat Ret **R10B**



30,5x60,5
12"x24"
Nat **R10B**

modular system



80x80
31½"x31½"
Nat Ret **R10B**

Decor / Decors



Mosaico 30x30
12"x12"
Nat Ret **R10B**



Max 11 mm Min 7 mm

Muretto 3D 15x61
6"x24"
Nat

8,8 mm



60x120
24"x48"
Nat Ret **R11C**



80x80
31½"x31½"
Nat Ret **R11C**

20 mm OUTDOOR



40x120
16"x48"
Nat Ret **R11C**



80x80
31½"x31½"
Nat Ret **R11C**

Ardesia

MARMO E PIETRA

100% DESIGN AND PRODUCTION OF ITALY

Sviluppo grafico per formato
Pattern by size
Développement graphique par format
Grafischer Entwurf für Format

60x120
8,8 mm
19

60x60
8,8 mm
31

30x60
8,8 mm
62

30,5x60,5
8,8 mm
62

80x80
8,8 mm
23

40x120
20 mm
28

80x80
20 mm
23

BIANCO 60x120 8,8 mm



8,8 mm

| | 60x120 24"x48" | 60x60 24"x24" | 30x60 12"x24" | 30,5x60,5 12"x24" | 80x80 31 1/2"x31 1/2" |
|------------|---------------------|---------------------|---------------------|----------------------|--------------------------|
| | Nat Ret R10B | Nat Ret R10B | Nat Ret R10B | Nat R10B | Nat Ret R10B |
| GRIGIO ● | 137004 | 137028 | 137040 | 137034 | 137016 |
| CENERE ● | 137003 | 137027 | 137039 | 137033 | 137015 |
| TAUPE ● | 137002 | 137026 | 137038 | 137032 | 137014 |
| BIANCO ● | 137001 | 137025 | 137037 | 137031 | 137013 |
| Price code | M097 | M083 | M081 | M065 | M097 |

| 8,8 mm | Mosaico 30x30 12"x12" | 7,11 mm | Muretto 3D 15x61 6"x24" |
|---------------|--------------------------|----------------|----------------------------|
| | Nat Ret R10B | | Nat |
| GRIGIO ● | 137204 | GRIGIO ● | 137046 |
| CENERE ● | 137203 | CENERE ● | 137045 |
| TAUPE ● | 137202 | TAUPE ● | 137044 |
| BIANCO ● | 137201 | BIANCO ● | 137043 |
| Price code | M135 | Price code | M083 |

| 8,8 mm | 60x120 24"x48" | 80x80 31 1/2"x31 1/2" | 20 mm | 40x120 16"x48" | 80x80 31 1/2"x31 1/2" |
|---------------|---------------------|--------------------------|--------------|---------------------|--------------------------|
| | Nat Ret R11C | Nat Ret R11C | | Nat Ret R11C | Nat Ret R11C |
| GRIGIO ● | 137010 | 137022 | GRIGIO ● | 137053 | 137060 |
| CENERE ● | 137009 | 137021 | CENERE ● | 137052 | 137059 |
| TAUPE ● | 137008 | 137020 | TAUPE ● | 137051 | 137058 |
| BIANCO ● | 137007 | 137019 | BIANCO ● | 137050 | 137057 |
| Price code | M097 | M097 | Price code | M131 | M137 |

Lo sviluppo grafico mostra solo una selezione dei pattern disponibili. Il numero totale delle grafiche è indicato di seguito.
 The graphic development shows only a selection of the available patterns. The total number of patterns is specified below.
 Le développement graphique montre uniquement une sélection des motifs disponibles. Le nombre total de motifs est indiqué ci-dessous.
 Die grafische Entwicklung zeigt nur eine Auswahl der verfügbaren Muster. Die Gesamtzahl der Muster ist unten angegeben.

PATTERNS 19

Pezzi Speciali / Trims. Pièces speciale. Die Sonderstücke

8,8 mm



Battiscopa
Skirting

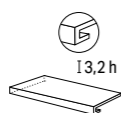

Gradino costa retta**
Straight-edge stair**

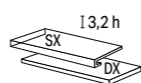

Gradino costa retta SX - DX**
Straight-edge step L-R

| | 6,5x120 | 8x80 | 33x120 | 33x80 | 33x60 | 33x120 | 33x80 | 33x60 |
|-------------------|---------------------|---------------------|---------------------|---------------------|---------------------|------------------------|------------------------|------------------------|
| | Nat Ret R10B | Nat Ret R10B | Nat Ret R10B | Nat Ret R10B | Nat Ret R10B | Nat Ret R10B | Nat Ret R10B | Nat Ret R10B |
| GRIGIO | 137104 | 137114 | 137350 | 137330 | 137310 | 137352 SX 137351 DX | 137332 SX 137331 DX | 137312 SX 137311 DX |
| CENERE | 137103 | 137112 | 137344 | 137324 | 137304 | 137346 SX 137345 DX | 137326 SX 137325 DX | 137306 SX 137305 DX |
| TAUPE | 137102 | 137113 | 137347 | 137327 | 137307 | 137349 SX 137348 DX | 137329 SX 137328 DX | 137309 SX 137308 DX |
| BIANCO | 137101 | 137111 | 137341 | 137321 | 137301 | 137343 SX 137342 DX | 137323 SX 137322 DX | 137303 SX 137302 DX |
| Price code | P040 | P029 | P207 | P167 | P135 | P219 | P179 | P151 |

20 mm



Griglia**
Drainage grid

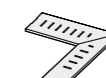

Griglia Angolo Sx/Dx**
Drainage grid - Corner L/R

| | 20x80 R11C | 20x60 R11C | 20x80 R11C | 20x60 R11C |
|-------------------|----------------------|----------------------|------------------------|------------------------|
| GRIGIO | 137772 | 137760 | 137780 SX 137776 DX | 137768 SX 137764 DX |
| CENERE | 137770 | 137758 | 137778 SX 137774 DX | 137766 SX 137762 DX |
| TAUPE | 137771 | 137759 | 137779 SX 137775 DX | 137767 SX 137763 DX |
| BIANCO | 137769 | 137757 | 137777 SX 137773 DX | 137765 SX 137761 DX |
| Price code | P239 | P205 | P239 | P205 |

La gamma completa dei pezzi speciali è disponibile nella "PARTE TECNICA" del catalogo a pag. 537
Our entire range of trims is available in our "TECHNICAL SECTION" of this catalogue pag. 537.
La gamme complète des pièces spéciales est disponible dans la section "PARTIE TECHNIQUE" à la pag. 537 de ce catalogue.
Das komplette Sortiment an Sonderstücken ist in dem "technischen Teil" des Katalogs auf Seite 537 verfügbar.

Calpestio . Foot traffic

• GRIGIO LOW • CENERE, TAUPE MEDIUM • BIANCO HIGH

8,8 mm

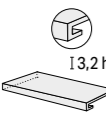

Gradino costa retta**
Straight-edge stair**

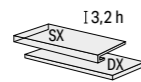

Gradino costa retta SX - DX**
Straight-edge step L-R

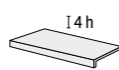

Elemento a "L" incollato**
L-shaped element glued

| | 33x120 | 33x80 | 33x120 | 33x80 | 30x120 |
|-------------------|---------------------|---------------------|------------------------|------------------------|---------------------|
| | Nat Ret R11C | Nat Ret R11C | Nat Ret R11C | Nat Ret R11C | Nat Ret R11C |
| GRIGIO | 137390 | 137370 | 137392 SX 137391 DX | 137372 SX 137371 DX | 137154 |
| CENERE | 137384 | 137364 | 137386 SX 137385 DX | 137366 SX 137365 DX | 137153 |
| TAUPE | 137387 | 137367 | 137389 SX 137388 DX | 137369 SX 137368 DX | 137152 |
| BIANCO | 137381 | 137361 | 137383 SX 137382 DX | 137363 SX 137362 DX | 137151 |
| Price code | P207 | P167 | P219 | P179 | P163 |

Imballi / Packings. Emballage. Verpackung

| | PCS/BOX | MQ/BOX | KG/BOX | BOX/PAL | MQ/PAL | KG/PAL | PACKING | PACKING SIZE |
|-------------------------|---------|--------|--------|---------|--------|--------|---------|----------------|
| 8,8 mm | | | | | | | | |
| 60 x 120 | 2 | 1,44 | 27,8 | 32 | 46,08 | 891 | EPAL | 80 x 120 x 75h |
| 60 x 120 R11 | 2 | 1,44 | 27,8 | 32 | 46,08 | 891 | EPAL | 80 x 120 x 75h |
| 60 x 60 | 3 | 1,08 | 19,8 | 40 | 43,20 | 791 | EPAL | 80 x 120 x 75h |
| 30 x 60 | 7 | 1,26 | 24 | 48 | 60,48 | 1.152 | EPAL | 80 x 120 x 75h |
| 30,5x60,5 | 7 | 1,29 | 23,4 | 48 | 61,92 | 1.125 | EPAL | 80 x 120 x 75h |
| 80 x 80 | 2 | 1,28 | 23,5 | 50 | 64,00 | 1.172 | EPAL | 80 x 120 x 95h |
| 80 x 80 R11 | 2 | 1,28 | 23,5 | 50 | 64,00 | 1.172 | EPAL | 80 x 120 x 95h |
| DECORI. DECORS | | | | | | | | |
| MOSAICO 30x30 | 6 | 0,54 | 13 | 54 | 29,16 | 701 | EPAL | 80 x 120 x 75h |
| 7 11 mm | | | | | | | | |
| DECORI. DECORS | | | | | | | | |
| MURETTO 3D 15x61 | 11 | 1,02 | 18,5 | 48 | 48,96 | 890 | EPAL | 80 x 120 x 76h |
| 20 mm | | | | | | | | |
| 40 x 120 | 2 | 0,96 | 43 | 24 | 23,04 | 1.032 | EPAL | 80 x 120 x 75h |
| 80 x 80 | 1 | 0,64 | 27,7 | 40 | 25,60 | 1.116 | EPAL | 80 x 120 x 95h |



20 mm

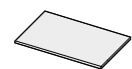

Gradone**
Large step

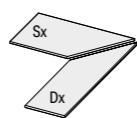

Gradone Angolo Sx/Dx**
Large step - corner L/R

| | 40x120 | | 40x80 | | 40x120 | | 40x80 | |
|-------------------|-----------------------------------|------------------------------------|-----------------------------------|------------------------------------|-----------------------------------|------------------------------------|-----------------------------------|------------------------------------|
| | Costa toro Nat Ret R11C | Costa retta Nat Ret R11C | Costa toro Nat Ret R11C | Costa retta Nat Ret R11C | Costa toro Nat Ret R11C | Costa retta Nat Ret R11C | Costa toro Nat Ret R11C | Costa retta Nat Ret R11C |
| GRIGIO | 137628 | 137616 | 137652 | 137640 | 137636 SX 137632 DX | 137624 SX 137620 DX | 137660 SX 137656 DX | 137648 SX 137644 DX |
| CENERE | 137626 | 137614 | 137650 | 137638 | 137634 SX 137630 DX | 137622 SX 137618 DX | 137658 SX 137654 DX | 137646 SX 137642 DX |
| TAUPE | 137627 | 137615 | 137651 | 137639 | 137635 SX 137631 DX | 137623 SX 137619 DX | 137659 SX 137655 DX | 137647 SX 137643 DX |
| BIANCO | 137625 | 137613 | 137649 | 137637 | 137633 SX 137629 DX | 137621 SX 137617 DX | 137657 SX 137653 DX | 137645 SX 137641 DX |
| Price code | P219 | P211 | P181 | P175 | P251 | P239 | P203 | P197 |

PEZZI SPECIALI. TRIMS

| | PCS/BOX | MQ/BOX | KG/BOX | PACKING | PACKING SIZE |
|--|---------|--------|--------|---------|--------------|
| 8,8 mm | | | | | |
| BATTISCOPA 6,5 x 120 | 6 | - | 11 | EPAL | 80 x 120 |
| BATTISCOPA 8 x 80 | 10 | - | 15 | EPAL | 80 x 120 |
| GRADINO COSTA RETTA 33 x 120 x 3,2h ** | 2 | - | 23 | EPAL | 80 x 120 |
| GRADINO COSTA RETTA 33 x 120 x 3,2h SX/DX ** | 1 | - | 12 | EPAL | 80 x 120 |
| GRADINO COSTA RETTA 33 x 80 x 3,2h ** | 2 | - | 16 | EPAL | 80 x 120 |
| GRADINO COSTA RETTA 33 x 80 x 3,2h SX/DX ** | 1 | - | 8,5 | EPAL | 80 x 120 |
| GRADINO COSTA RETTA 33 x 60 x 3,2h ** | 4 | - | 23 | EPAL | 80 x 120 |
| GRADINO COSTA RETTA 33 x 60 x 3,2h SX/DX ** | 2 | - | 12 | EPAL | 80 x 120 |
| ELEMENTO A L INCOLLATO 30 x 120 x 4h ** | 2 | - | 20 | EPAL | 80 x 120 |
| 20 mm | | | | | |
| GRADONE 40 x 120 ** | 1 | - | 21,5 | EPAL | 80 x 120 |
| GRADONE 40 x 120 SX/DX ** | 1 | - | 21,5 | EPAL | 80 x 120 |
| GRADONE 40 x 80 ** | 1 | - | 12,5 | EPAL | 80 x 120 |
| GRADONE 40 x 80 SX/DX ** | 1 | - | 12,5 | EPAL | 80 x 120 |
| GRIGLIA 20 x 80 ** | 1 | - | 8 | EPAL | 80 x 120 |
| GRIGLIA 20 x 80 SX/DX ** | 1 | - | 7,5 | EPAL | 80 x 120 |
| GRIGLIA 20 x 60 ** | 1 | - | 6 | EPAL | 80 x 120 |
| GRIGLIA 20 x 60 SX/DX ** | 1 | - | 5,5 | EPAL | 80 x 120 |

** A disposizione solo su richiesta.
Tempi di consegna: 30gg
Available upon request only.
Delivery terms: 30 days
Disponible seulement sur requête. Délais de livraison: 30 jours
Verfügbar auf Anfrage.
Lieferzeit: 30 Tage

La gamma completa dei pezzi speciali è disponibile nella "PARTE TECNICA" del catalogo a pag. 537
Our entire range of trims is available in our "TECHNICAL SECTION" of this catalogue pag. 537.
La gamme complète des pièces spéciales est disponible dans la section "PARTIE TECHNIQUE" à la pag. 537 de ce catalogue.
Das komplette Sortiment an Sonderstücken ist in dem "technischen Teil" des Katalogs auf Seite 537 verfügbar.

Storm

MARMO E PIETRA



DARK

FOG

SALT

SAND



Gres Porcellanato. Porcelain tiles
Grès cérame. Feinsteinzeug
ISO 13006 - G - Bla_E ≤ 0,5%
UNI EN 14411

ANSI A - 326.3: 2021
W E T D Y N A M I C
COEFFICIENT OF FRICTION

DCOF ≥ 0,42

8,8 mm



60x120
24"x48"
Nat Ret **R10B**



60x60
24"x24"
Nat Ret **R10B**



30x60
12"x24"
Nat Ret **R10B**

modular system

Decori / Decors



Mosaico 30x30
12"x12"
Nat Ret

8,8 mm



30,5x60,5
12"x24"
Nat **R11C**

20 mm OUTDOOR



80x80
31 1/2"x31 1/2"
Nat Ret **R11C**



60x60
24"x24"
Nat Ret **R11C**

Storm

MARMO E PIETRA

100% DESIGN AND PRODUCTION OF ITALY

Sviluppo grafico per formato
Pattern by size
Développement graphique par format
Grafischer Entwurf für Format

60x120
8,8 mm
24

60x60
8,8 mm
52

30x60
8,8 mm
76

30,5x60,5
8,8 mm
76

80x80
20 mm
24

60x60
20 mm
52

Sviluppo Grafico

Pattern by size. Développement graphique par format. Grafischer Entwurf für Format

FOG 60x120 8,8 mm



Lo sviluppo grafico mostra solo una selezione dei pattern disponibili. Il numero totale delle grafiche è indicato di seguito.
 The graphic development shows only a selection of the available patterns. The total number of patterns is specified below.
 Le développement graphique montre uniquement une sélection des motifs disponibles. Le nombre total de motifs est indiqué ci-dessous.
 Die grafische Entwicklung zeigt nur eine Auswahl der verfügbaren Muster. Die Gesamtzahl der Muster ist unten angegeben.

PATTERNS 24



Floor
 Fog 80x180_31 1/2"x71" - 80x80_31 1/2"x31 1/2" Nat Ret
 Fog Gradino Costa Retta 33x80x3,2h_13"x31 1/2"x1 1/4" h

| | 8,8 mm | | | |
|------------|---------------------|---------------------|---------------------|--------------------------|
| | 60x120 24"x48" | 60x60 24"x24" | 30x60 12"x24" | Mosaico 30x30 12"x12" |
| | Nat Ret R10B | Nat Ret R10B | Nat Ret R10B | Nat Ret R10B |
| DARK ● | 117013 | 117046 | 117071 | 117093 |
| FOG ● | 117012 | 117045 | 117070 | 117092 |
| SALT ● | 117010 | 117043 | 117068 | 117090 |
| SAND ● | 117011 | 117044 | 117069 | 117091 |
| Price code | M097 | M083 | M081 | M135 |

| | 8,8 mm | | | 20 mm | |
|------------|----------------------|--------------------------|---------------------|--------------------------|---------------------|
| | 30,5x60,5 12"x24" | 80x80 31 1/2"x31 1/2" | 60x60 24"x24" | 80x80 31 1/2"x31 1/2" | 60x60 24"x24" |
| | Nat R11C | Nat Ret R11C | Nat Ret R11C | Nat Ret R11C | Nat Ret R11C |
| DARK ● | 117063 | 117026 | 117051 | 117026 | 117051 |
| FOG ● | 117062 | 117025 | 117050 | 117025 | 117050 |
| SALT ● | 117060 | 117023 | 117048 | 117023 | 117048 |
| SAND ● | 117061 | 117024 | 117049 | 117024 | 117049 |
| Price code | M065 | M137 | M117 | M137 | M117 |

Pezzi Speciali / Trims. Pièces speciale. Die Sonderstücke

8,8 mm



Battiscopa
Skirting

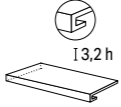

Gradino costa retta**
Straight-edge stair**

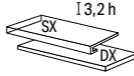

Gradino costa retta SX - DX**
Straight-edge step L-R

| | 6,5x120 | 7x60 | 33x120 | 33x60 | 33x120 | 33x60 |
|-------------------|---------------------|---------------------|---------------------|---------------------|------------------------|------------------------|
| | Nat Ret R10B | Nat Ret R10B | Nat Ret R10B | Nat Ret R10B | Nat Ret R10B | Nat Ret R10B |
| DARK | 117098 | 117104 | 117210 | 117234 | 117212 SX 117211 DX | 117236 SX 117235 DX |
| FOG | 117097 | 117103 | 117207 | 117231 | 117209 SX 117208 DX | 117233 SX 117232 DX |
| SALT | 117095 | 117101 | 117201 | 117225 | 117203 SX 117202 DX | 117227 SX 117226 DX |
| SAND | 117096 | 117102 | 117204 | 117228 | 117206 SX 117205 DX | 117230 SX 117229 DX |
| Price code | P040 | P021 | P207 | P135 | P219 | P151 |

20 mm

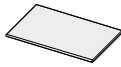

Gradone**
Large step

| | 40x80 | | 30x60 | |
|-------------------|-----------------------------------|------------------------------------|-----------------------------------|------------------------------------|
| | Costa toro Nat Ret R11C | Costa retta Nat Ret R11C | Costa toro Nat Ret R11C | Costa retta Nat Ret R11C |
| DARK | 117418 | 117407 | 1170606 | 117594 |
| FOG | 117417 | 117406 | 117605 | 117593 |
| SALT | 117416 | 117404 | 117603 | 117591 |
| SAND | 117251 | 117405 | 117604 | 117592 |
| Price code | P181 | P175 | P135 | P135 |

20 mm

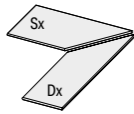

Gradone Angolo Sx/Dx
Large step - Corner L/R

| | 40x80 | | 30x60 | |
|-------------------|-----------------------------------|------------------------------------|-----------------------------------|------------------------------------|
| | Costa toro Nat Ret R11C | Costa retta Nat Ret R11C | Costa toro Nat Ret R11C | Costa retta Nat Ret R11C |
| DARK | 117426 SX 117422 DX | 117415 SX 117411 DX | 117614 SX 117610 DX | 117602 SX 117598 DX |
| FOG | 117425 SX 117421 DX | 117414 SX 117410 DX | 117613 SX 117609 DX | 117601 SX 117597 DX |
| SALT | 117423 SX 117419 DX | 117412 SX 117408 DX | 117611 SX 117607 DX | 117599 SX 117595 DX |
| SAND | 117424 SX 117420 DX | 117413 SX 117409 DX | 117612 SX 117608 DX | 117600 SX 117596 DX |
| Price code | P203 | P197 | P151 | P145 |

20 mm



Griglia**
Drainage grid



Griglia - Angolo Sx/Dx**
Drainage grid - Corner L/R

| | 15x60 R11C | 20x80 R11C | 30x60 R11C | 15x60 R11C | 20x80 R11C | 30x60 R11C |
|-------------------|----------------------|----------------------|----------------------|------------------------|------------------------|------------------------|
| DARK | 117494 | 117470 | 117706 | 117708 SX 117498 DX | 117478 SX 117474 DX | 117514 SX 117510 DX |
| FOG | 117493 | 117469 | 117705 | 117707 SX 117497 DX | 117477 SX 117473 DX | 117513 SX 117509 DX |
| SALT | 117491 | 117467 | 117703 | 117499 SX 117495 DX | 117475 SX 117471 DX | 117511 SX 117507 DX |
| SAND | 117492 | 117468 | 117704 | 117500 SX 117496 DX | 117476 SX 117472 DX | 117512 SX 117508 DX |
| Price code | P195 | P239 | P217 | P195 | P239 | P217 |

Calpestio. Foot traffic

•DARK  LOW •FOG, SAND  MEDIUM •SALT  HIGH

Imballi / Packings. Emballage. Verpackung

| | PCS/BOX | MQ/BOX | KG/BOX | BOX/PAL | MQ/PAL | KG/PAL | PACKING | PACKING SIZE |
|------------------------|---------|--------|--------|---------|--------|--------|---------|----------------|
| 8,8 mm | | | | | | | | |
| 60 x 120 | 2 | 1,44 | 28 | 32 | 46,08 | 896 | EPAL | 80 x 120 x 75h |
| 60 x 60 | 3 | 1,08 | 20,5 | 40 | 43,20 | 820 | EPAL | 80 x 120 x 75h |
| 30 x 60 | 7 | 1,26 | 24 | 48 | 60,48 | 1.154 | EPAL | 80 x 120 x 75h |
| 30,5 x 60,5 R11 | 7 | 1,29 | 24 | 48 | 61,90 | 1.151 | EPAL | 80 x 120 x 75h |
| DECORI. DECORS | | | | | | | | |
| MOSAICO 30 x 30 | 6 | 0,54 | 12,15 | - | - | - | EPAL | 80 x 120 |
| 20 mm | | | | | | | | |
| 80 x 80 | 1 | 0,64 | 28,2 | 40 | 25,60 | 1.130 | EPAL | 80 x 120 x 95h |
| 60 x 60 | 2 | 0,72 | 32 | 32 | 23,04 | 1.024 | EPAL | 80 x 120 x 75h |



EPAL



Pallet speciale con sponde
Special pallet with sides.
Palette spéciale avec bords.
Spezial-Palette mit Wandungen.

| PEZZI SPECIALI. TRIMS | PCS/BOX | MQ/BOX | KG/BOX | PACKING | PACKING SIZE |
|---------------------------------------|---------|--------|--------|---------|--------------|
| 8,8 mm | | | | | |
| BATTISCOPA 6,5 x 120 | 6 | - | 11 | EPAL | 80 x 120 |
| BATTISCOPA 7 x 60 | 15 | - | 14,7 | EPAL | 80 x 120 |
| GRADINO COSTA RETTA 33 x 120 ** | 2 | - | 23 | EPAL | 80 x 120 |
| GRADINO COSTA RETTA 33 x 120 Sx/Dx ** | 1 | - | 12 | EPAL | 80 x 120 |
| GRADINO COSTA RETTA 33 x 60 ** | 4 | - | 23 | EPAL | 80 x 120 |
| GRADINO COSTA RETTA 33 x 60 Sx/Dx** | 2 | - | 12 | EPAL | 80 x 120 |
| 20 mm | | | | | |
| GRADONE 40 x 80 ** | 1 | - | 12,5 | EPAL | 80 x 120 |
| GRADONE 40 x 80 SX/DX ** | 1 | - | 12,5 | EPAL | 80 x 120 |
| GRADONE 30 x 60 ** | 1 | - | 9 | EPAL | 80 x 120 |
| GRADONE 30 x 60 SX/DX ** | 1 | - | 6,6 | EPAL | 80 x 120 |
| GRADONE 15 x 60 ** | 1 | - | 4,5 | EPAL | 80 x 120 |
| GRADONE 15 x 60 SX/DX ** | 1 | - | 3,8 | EPAL | 80 x 120 |
| GRIGLIA 15 x 60 ** | 1 | - | 4,2 | EPAL | 80 x 120 |
| GRIGLIA 15 x 60 SX/DX ** | 1 | - | 3,6 | EPAL | 80 x 120 |
| GRIGLIA 20 x 80 ** | 1 | - | 8 | EPAL | 80 x 120 |
| GRIGLIA 20 x 80 SX/DX ** | 1 | - | 7,5 | EPAL | 80 x 120 |
| GRIGLIA 30 x 60 ** | 1 | - | 8,4 | EPAL | 80 x 120 |
| GRIGLIA 30 x 60 SX/DX ** | 1 | - | 7,2 | EPAL | 80 x 120 |

**** A disposizione solo su richiesta.**
Tempi di consegna: 30gg
Available upon request only.
Delivery terms: 30 days
Disponible seulement sur requête.
Délais de livraison: 30 jours
Verfügbar auf Anfrage.
Lieferzeit: 30 Tage

La gamma completa dei pezzi speciali è disponibile nella "PARTE TECNICA" del catalogo a pag. 537
Our entire range of trims is available in our "TECHNICAL SECTION" of this catalogue pag. 537.
La gamme complète des pièces spéciales est disponible dans la section "PARTIE TECHNIQUE" à la pag. 537 de ce catalogue.
Das komplette Sortiment an Sonderstücken ist in dem "technischen Teil" des Katalogs auf Seite 537 verfügbar.



Dolomiti

MARMO E PIETRA

BASALTO

CENERE

CALCITE

SABBIA



Gres Porcellanato. Porcelain tiles
Grès cérame. Feinsteinzeug
ISO 13006 - G - Bla_E ≤ 0,5%
UNI EN 14411

ANSI A - 326.3: 2021
W E T D Y N A M I C
COEFFICIENT OF FRICTION

DCOF ≥ 0,42 | naturale

8,8 mm



60x120
24"x48"
Liscio Ret **R10B**



60x60
24"x24"
Liscio Ret **R10B**



30x60
12"x24"
Liscio Ret **R10B**



30,5x60,5
12"x24"
Liscio **R10B**

modular system

8,8 mm



60x120
24"x48"
Strutturato Ret **R11C**



60x60
24"x24"
Strutturato Ret **R11C**



30,5x60,5
12"x24"
Strutturato **R11C**

20 mm OUTDOOR



40x120
16"x48"
Strutturato Ret **R11C**

Dolomiti

MARMO E PIETRA

100% DESIGN AND PRODUCTION OF ITALY

Sviluppo grafico per formato
Pattern by size
Développement graphique par format
Grafischer Entwurf für Format

60x120
8,8 mm
19

60x60
8,8 mm
44

30x60
8,8 mm
12

30,5x60,5
8,8 mm
12

40x120
20 mm
24

CENERE 60x120 8,8 mm



Lo sviluppo grafico mostra solo una selezione dei pattern disponibili. Il numero totale delle grafiche è indicato di seguito.
 The graphic development shows only a selection of the available patterns. The total number of patterns is specified below.
 Le développement graphique montre uniquement une sélection des motifs disponibles. Le nombre total de motifs est indiqué ci-dessous.
 Die grafische Entwicklung zeigt nur eine Auswahl der verfügbaren Muster. Die Gesamtzahl der Muster ist unten angegeben.

PATTERNS 19

8,8 mm

| | 60x120 24"x48" | 60x60 24"x24" | 30x60 12"x24" | 30,5x60,5 12"x24" |
|------------|------------------------|------------------------|------------------------|------------------------|
| | Liscio Ret R10B | Liscio Ret R10B | Liscio Ret R10B | Liscio Ret R10B |
| BASALTO | 086019 | 086059 | 086117 | 086089 |
| CENERE | 086013 | 086053 | 086111 | 086083 |
| CALCITE | 086001 | 086041 | 086101 | 086071 |
| SABBIA | 086007 | 086047 | 086107 | 086077 |
| Price code | M109 | M089 | M089 | M073 |

8,8 mm

| | 60x120 24"x48" | 60x60 24"x24" | 30,5x60,5 12"x24" |
|------------|-----------------------------|-----------------------------|-------------------------|
| | Strutturato Ret R11C | Strutturato Ret R11C | Strutturato R11C |
| BASALTO | 086022 | 086062 | 086091 |
| CENERE | 086016 | 086056 | 086085 |
| CALCITE | 086004 | 086044 | 086073 |
| SABBIA | 086010 | 086050 | 086079 |
| Price code | M109 | M089 | M073 |

20 mm

| | 40x120 16"x48" |
|------------|-----------------------------|
| | Strutturato Ret R11C |
| BASALTO | 086034 |
| CENERE | 086033 |
| CALCITE | 086031 |
| SABBIA | 086032 |
| Price code | M131 |

Dolomiti

Pezzi Speciali / Trims. Pièces speciale. Die Sonderstücke

8,8 mm

Battiscopa
Skirting

9,5x60

Liscio Ret **R10B**

| | |
|-------------------|-------------|
| BASALTO | 086193 |
| CENERE | 086187 |
| CALCITE | 086175 |
| SABBIA | 086181 |
| Price code | P021 |

8,8 mm

Gradino costa retta**
Straight-edge stair**

Gradino costa retta SX - DX**
Straight-edge step L-R

| | 33x120 | | 33x60 | |
|-------------------|------------------------|------------------------|------------------------|------------------------|
| | Liscio Ret R10B | Liscio Ret R10B | Liscio Ret R10B | Liscio Ret R10B |
| BASALTO | 086613 | 086664 | 086645 SX 086628 DX | 086831 SX 086819 DX |
| CENERE | 086609 | 086803 | 086641 SX 086625 DX | 086828 SX 086816 DX |
| CALCITE | 086601 | 086802 | 086631 SX 086619 DX | 086822 SX 086810 DX |
| SABBIA | 086606 | 086806 | 086634 SX 086622 DX | 086825 SX 086813 DX |
| Price code | P207 | P141 | P231 | P169 |

20 mm

Gradone**
Large step

Gradone Angolo Sx/Dx**
Large step - corner L/R

| | 40x120 | | 40x120 | |
|-------------------|-------------------------------------|--------------------------------------|-------------------------------------|--------------------------------------|
| | Costa toro Strut Ret R11C | Costa retta Strut Ret R11C | Costa toro Strut Ret R11C | Costa retta Strut Ret R11C |
| BASALTO | 086236 | 086230 | 086260 SX 086248 DX | 086254 SX 086242 DX |
| CENERE | 086235 | 086229 | 086259 SX 086247 DX | 086253 SX 086241 DX |
| CALCITE | 086233 | 086227 | 086257 SX 086245 DX | 086251 SX 086239 DX |
| SABBIA | 086234 | 086228 | 086258 SX 086246 DX | 086252 SX 086240 DX |
| Price code | P219 | P211 | P251 | P239 |

Calpestio. Foot traffic

• BASALTO LOW • SABBIA MEDIUM • CALCITE, CENERE HIGH



Floor
Ceneri 40x120_16"x48" 20mm R11

Imballi / Packings. Emballage. Verpackung

| | PCS/BOX | MQ/BOX | KG/BOX | BOX/PAL | MQ/PAL | KG/PAL | PACKING | PACKING SIZE |
|---------------|---------|--------|--------|---------|--------|--------|---------|----------------|
| 8,8 mm | | | | | | | | |
| 60 x 120 | 2 | 1,44 | 27,9 | 32 | 46,08 | 893 | EPAL | 80 x 120 x 75h |
| 60 x 60 | 3 | 1,08 | 21 | 40 | 43,20 | 840 | EPAL | 80 x 120 x 75h |
| 30 x 60 | 7 | 1,26 | 24 | 48 | 60,48 | 1.154 | EPAL | 80 x 120 x 75h |
| 30,5 x 60,5 | 7 | 1,29 | 24 | 48 | 61,92 | 1.152 | EPAL | 80 x 120 x 75h |
| 20 mm | | | | | | | | |
| 40 x 120 | 2 | 0,96 | 43 | 24 | 23,04 | 1.032 | EPAL | 80 x 120 x 75h |



PEZZI SPECIALI. TRIMS

| | PCS/BOX | MQ/BOX | KG/BOX | PACKING | PACKING SIZE |
|--|---------|--------|--------|---------|--------------|
| 8,8 mm | | | | | |
| BATTISCOPA 9,5 x 60 | 12 | - | 14,5 | EPAL | 80 x 120 |
| GRADINO COSTA RETTA 33 x 120 x 3,2h ** | 2 | - | 23 | EPAL | 80 x 120 |
| GRADINO COSTA RETTA 33 x 120 x 3,2h SX/DX ** | 1 | - | 12 | EPAL | 80 x 120 |
| GRADINO COSTA RETTA 33 x 60 x 3,2h ** | 4 | - | 23 | EPAL | 80 x 120 |
| GRADINO COSTA RETTA 33 x 60 x 3,2h SX/DX ** | 2 | - | 12 | EPAL | 80 x 120 |
| 20 mm | | | | | |
| GRADONE 40 x 120 ** | 1 | - | 22,5 | EPAL | 80 x 120 |
| GRADONE 40 x 120 Sx/Dx ** | 1 | - | 22,5 | EPAL | 80 x 120 |
| GRIGLIA 20 x 60 ** | 1 | - | 6 | EPAL | 80 x 120 |
| GRIGLIA 20 x 60 Sx/Dx ** | 1 | - | 6 | EPAL | 80 x 120 |

**** A disposizione solo su richiesta.**
Tempi di consegna: 30gg
Available upon request only.
Delivery terms: 30 days
Disponible seulement sur requête.
Délais de livraison: 30 jours
Verfügbar auf Anfrage.
Lieferzeit: 30 Tage

La gamma completa dei pezzi speciali è disponibile nella "PARTE TECNICA" del catalogo a pag. 537
Our entire range of trims is available in our "TECHNICAL SECTION" of this catalogue pag. 537.
La gamme complète des pièces spéciales est disponible dans la section "PARTIE TECHNIQUE" à la pag. 537 de ce catalogue.
Das komplette Sortiment an Sonderstücken ist in dem "technischen Teil" des Katalogs auf Seite 537 verfügbar.



Blue Evolution

MARMO E PIETRA

BLACK

ANTHRACITE

GREY

20 mm OUTDOOR



80x80
31 1/2"x31 1/2"
Nat Ret **R11C**



Gres Porcellanato. Porcelain tiles
Grès cérame. Feinsteinzeug
ISO 13006 - G - Bla_E ≤ 0,5%
UNI EN 14411

ANSI A - 326.3: 2021
W E T D Y N A M I C
COEFFICIENT OF FRICTION

DCOF ≥ 0,42

Blue Evolution

MARMO E PIETRA

100% DESIGN AND PRODUCTION OF ITALY

Sviluppo grafico per formato
Pattern by size
Développement graphique par format
Grafischer Entwurf für Format

80x80
20 mm
19

ANTHRACITE 80x80



Lo sviluppo grafico mostra solo una selezione dei pattern disponibili. Il numero totale delle grafiche è indicato di seguito.

The graphic development shows only a selection of the available patterns. The total number of patterns is specified below.

Le développement graphique montre uniquement une sélection des motifs disponibles. Le nombre total de motifs est indiqué ci-dessous.

Die grafische Entwicklung zeigt nur eine Auswahl der verfügbaren Muster. Die Gesamtzahl der Muster ist unten angegeben.

PATTERNS 19

20 mm

80x80
31 1/2"x31 1/2"

Nat Ret **R11C**

| | |
|------------|--------|
| BLACK | 092044 |
| ANTHRACITE | 092042 |
| GREY | 092040 |
| Price code | M137 |

Pezzi Speciali / Trims. Pièces speciale. Die Sonderstücke

20 mm

| | Gradone ** Large step 40x80 | | Gradone Angolo Sx/Dx ** Large step - Corner L/R 40x80 | | Griglia ** Drainage grid 20x80 R11C | Griglia - Angolo Sx/Dx ** Drainage grid - Corner L/R 20x80 R11C |
|------------|-----------------------------------|------------------------------------|---|------------------------------------|--|--|
| | Costa toro Nat Ret R11C | Costa retta Nat Ret R11C | Costa toro Nat Ret R11C | Costa retta Nat Ret R11C | | |
| BLACK | 092256 | 092259 | 092387SX 092262 DX | 092265 SX 092383 DX | 092367 | 092373 SX 092370 DX |
| ANTHRACITE | 092255 | 092258 | 092386 SX 092261 DX | 092264 SX 092346 DX | 092366 | 092372 SX 092369 DX |
| GREY | 092384 | 092344 | 092385 SX 092260 DX | 092263 SX 092345 DX | 092365 | 092371 SX 092368 DX |
| Price code | P181 | P175 | P203 | P197 | P239 | P239 |

Calpestio. Foot traffic

• BLACK, ANTHRACITE LOW • GREY MEDIUM

Imballi / Packings. Emballage. Verpackung

20 mm

| | PCS/BOX | MQ/BOX | KG/BOX | BOX/PAL | MQ/PAL | KG/PAL | PACKING | PACKING SIZE |
|---------|---------|--------|--------|---------|--------|--------|---------|----------------|
| 80 x 80 | 1 | 0,64 | 28,5 | 40 | 25,60 | 1.139 | EPAL | 80 x 120 x 95h |



20 mm

| PEZZI SPECIALI. TRIMS | PCS/BOX | MQ/BOX | KG/BOX | PACKING | PACKING SIZE |
|--------------------------|---------|--------|--------|---------|--------------|
| GRIGLIA 20 x 80 ** | 1 | - | 8 | EPAL | 80 x 120 |
| GRIGLIA 20 x 80 SX/DX ** | 1 | - | 7,5 | EPAL | 80 x 120 |
| GRADONE 40 x 80 ** | 1 | - | 12,5 | EPAL | 80 x 120 |
| GRADONE 40 x 80 SX/DX ** | 1 | - | 12,5 | EPAL | 80 x 120 |

** A disposizione solo su richiesta. Tempi di consegna: 30gg
Available upon request only. Delivery terms: 30 days
Disponible seulement sur requête. Délais de livraison: 30 jours
Verfügbar auf Anfrage. Lieferzeit: 30 Tage

La gamma completa dei pezzi speciali è disponibile nella "PARTE TECNICA" del catalogo a pag. 537
Our entire range of trims is available in our "TECHNICAL SECTION" of this catalogue pag. 537.
La gamme complète des pièces spéciales est disponible dans la section "PARTIE TECHNIQUE" à la pag. 537 de ce catalogue.
Das komplette Sortiment an Sonderstücken ist in dem "technischen Teil" des Katalogs auf Seite 537 verfügbar.



I Quarzi

MARMO E PIETRA

ANTRACITE

PRASIO

DIASPRO

MADERA

8,8 mm



60x60
24"x24"
Nat Ret R10A



30x60
12"x24"
Nat Ret R10A



30x30
12"x12"
Nat Ret R10A



30,5x60,5
12"x24"
Nat R10A

modular system

Decori / Decors



Mosaico 30x30
12"x12"
Nat Ret R10A



Muretto 15x60
6"x24"
Nat Ret R10A

8,8 mm



60x60
24"x24"
Nat Ret R11C



30x60
12"x24"
Nat Ret R11C



30x30
12"x12"
Nat Ret R11C



30,5x60,5
12"x24"
Nat R11C



20,3x40,6
8"x16"
Nat R11C

modular system

20 mm OUTDOOR



60x60
24"x24"
Nat Ret R11C



Gres Porcellanato, Porcelain tiles
Grès cérame, Feinsteinzeug
ISO 13006 - G - Bla_E ≤ 0,5%
UNI EN 14411

ANSI A - 326.3: 2021
W E T D Y N A M I C
COEFFICIENT OF FRICTION

DCOF ≥ 0,42

SHADE SPECTRUM

I Quarzi

MARMO E PIETRA

100% DESIGN AND PRODUCTION OF ITALY

| | | | | | | |
|--|-----------------------|-----------------------|---------------------------|-----------------------|---------------------------|----------------------|
| Sviluppo grafico per formato Pattern by size Développement graphique par format Grafischer Entwurf für Format | 60x60 8,8 mm 14 | 30x60 8,8 mm 46 | 30,5x60,5 8,8 mm 46 | 30x30 8,8 mm 56 | 20,3x40,6 8,8 mm 46 | 60x60 20 mm 14 |
|--|-----------------------|-----------------------|---------------------------|-----------------------|---------------------------|----------------------|

Sviluppo Grafico

Pattern by size. Développement graphique par format. Grafischer Entwurf für Format

PRASIO 60x60 8,8 mm



Lo sviluppo grafico mostra solo una selezione dei pattern disponibili. Il numero totale delle grafiche è indicato di seguito.
The graphic development shows only a selection of the available patterns. The total number of patterns is specified below.
Le développement graphique montre uniquement une sélection des motifs disponibles. Le nombre total de motifs est indiqué ci-dessous.
Die grafische Entwicklung zeigt nur eine Auswahl der verfügbaren Muster. Die Gesamtzahl der Muster ist unten angegeben.

PATTERNS 14



Wall
Ardesia Muretto 3D Cenere 15x61_6"x24" Nat

Floor
Prasio 60x60_24"x24" - 30x60_12"x24" - 30x30_12"x12" Nat Ret

I Quarzi

8,8 mm

| | 60x60 24"x24" | 30x60 12"x24" | 30,5x60,5 12"x24" | 30x30 12"x12" |
|------------|---------------------|---------------------|----------------------|---------------------|
| | Nat Ret R10A | Nat Ret R10A | Nat R10A | Nat Ret R10A |
| ANTRACITE | 662RI4 | V62RI4 | V62NI4 | 962RI4 |
| PRASIO | 662RI3 | V62RI3 | V62NI3 | 962RI3 |
| DIASPRO | 662RI1 | V62RI1 | V62NI1 | 962RI1 |
| MADERA | 662RI2 | V62RI2 | V62NI2 | 962RI2 |
| Price code | M089 | M089 | M073 | M111 |

8,8 mm

| | Mosaico 30x30 12"x12" | Muretto 15x60 6"x24" |
|------------|--------------------------|-------------------------|
| | Nat Ret R10A | Nat Ret R10A |
| ANTRACITE | 962RI9 | L62RI8 |
| PRASIO | 962RI8 | L62RI7 |
| DIASPRO | 962RI6 | L62RI5 |
| MADERA | 962RI7 | L62RI6 |
| Price code | M159 | M185 |

8,8 mm

| | 60x60 24"x24" | 30x60 12"x24" | 30,5x60,5 12"x24" | 30x30 12"x12" | 20,3x40,6 8"x16" |
|------------|---------------------|---------------------|----------------------|------------------|---------------------|
| | Nat Ret R11C | Nat Ret R11C | Nat R11C | Nat R11C | Nat R11C |
| ANTRACITE | 662RE4 | V62RE4 | V62NE4 | 962RE4 | - |
| PRASIO | 662RE3 | V62RE3 | V62NE3 | 962RE3 | 242NE3 |
| DIASPRO | 662RE1 | V62RE1 | V62NE1 | 962RE1 | 242NE1 |
| MADERA | 662RE2 | V62RE2 | V62NE2 | 962RE2 | 242NE2 |
| Price code | M089 | M089 | M073 | M111 | M083 |

20 mm

| | 60x60 24"x24" |
|------------|---------------------|
| | Nat Ret R11C |
| ANTRACITE | 662RE8 |
| PRASIO | 662RE7 |
| DIASPRO | 662RE5 |
| MADERA | 662RE6 |
| Price code | M117 |

Pezzi Speciali / Trims. Pièces speciale. Die Sonderstücke

8,8 mm

| | Battiscopa Skirting 9,5x60 | Gradino costa retta** Straight-edge stair** 33x60 | Gradino costa retta SX - DX** Straight-edge step L-R 33x60 |
|------------|----------------------------------|--|---|
| | Nat Ret R10A | Nat Ret R10A | Nat Ret R10A |
| ANTRACITE | B62RI4 | K62RI8 | J62RS8 SX J62RD8 DX |
| PRASIO | B62RI3 | K62RI7 | J62RS7 SX J62RD7 DX |
| DIASPRO | B62RI1 | K62RI5 | J62RS5 SX J62RD5 DX |
| MADERA | B62RI2 | K62RI6 | J62RS6 SX J62RD6 DX |
| Price code | P021 | P141 | P169 |

8,8 mm

| | Gradino costa retta** Straight-edge stair** 33x60 | Gradino costa retta SX - DX** Straight-edge step L-R 33x60 | Elle monolitico estruso ** Extruded L-shaped monoblock tile 15x30x4 |
|------------|--|---|--|
| | Nat Ret R11C | Nat Ret R11C | Nat R11C |
| ANTRACITE | K62RE8 | J62RE8S SX J62RE8D DX | 062278 |
| PRASIO | K62RE7 | J62RE7S SX J62RE7D DX | 062277 |
| DIASPRO | K62RE5 | J62RE5S SX J62RE5D DX | 062275 |
| MADERA | K62RE6 | J62RE6S SX J62RE6D DX | 062276 |
| Price code | P141 | P169 | P044 |

20 mm

| | 30x60 | | 30x60 | | 15x60 R11C | 30x60 R11C | 15x60 R11C | 30x60 R11C |
|------------|-----------------------------------|------------------------------------|-----------------------------------|------------------------------------|----------------------|----------------------|------------------------|------------------------|
| | Costa toro Nat Ret R11C | Costa retta Nat Ret R11C | Costa toro Nat Ret R11C | Costa retta Nat Ret R11C | | | | |
| ANTRACITE | 062154 | 062150 | 062172 SX 062163 DX | 062168 SX 062159 DX | 062246 | 062231 | 062256 SX 062251 DX | 062241 SX 062236 DX |
| PRASIO | 062153 | 062149 | 062171 SX 062162 DX | 062167 SX 062158 DX | 062245 | 062230 | 062255 SX 062250 DX | 062240 SX 062235 DX |
| DIASPRO | 062151 | 062147 | 062169 SX 062160 DX | 062165 SX 062156 DX | 062243 | 062228 | 062253 SX 062248 DX | 062238 SX 062233 DX |
| MADERA | 062152 | 062148 | 062170 SX 062161 DX | 062166 SX 062157 DX | 062244 | 062229 | 062254 SX 062249 DX | 062239 SX 062234 DX |
| Price code | P135 | P135 | P151 | P145 | P195 | P217 | P195 | P217 |

Calpestio . Foot traffic

• ANTRACITE LOW • PRASIO, MADERA MEDIUM • DIASPRO HIGH

Imballi / Packings. Emballage. Verpackung

| | PCS/BOX | MQ/BOX | KG/BOX | BOX/PAL | MQ/PAL | KG/PAL | PACKING | PACKING SIZE |
|----------------|---------|--------|--------|---------|--------|--------|---------|----------------|
| 8,8 mm | | | | | | | | |
| 60 x 60 | 3 | 1,08 | 21 | 40 | 43,20 | 840 | EPAL | 80 x 120 x 75h |
| 30 x 60 | 7 | 1,26 | 24 | 48 | 60,48 | 1.152 | EPAL | 80 x 120 x 75h |
| 30,5 x 60,5 | 7 | 1,29 | 24 | 48 | 61,92 | 1.152 | EPAL | 80 x 120 x 76h |
| 30 x 30 | 12 | 1,08 | 22,3 | 40 | 43,20 | 892 | EPAL | 80 x 120 x 75h |
| 20,3 x 40,6 | 13 | 1,07 | 20,3 | 72 | 77,04 | 1.464 | EPAL | 80 x 120 x 96h |
| DECORI. DECORS | | | | | | | | |
| MOSAICO 30x30 | 6 | 0,54 | 13 | 54 | 29,16 | 702 | EPAL | 80 x 120 x 75h |
| MURETTO 15x60 | 3 | 0,27 | 6 | 98 | 26,46 | 587 | EPAL | 80 x 120 x 70h |
| 20 mm | | | | | | | | |
| 60 x 60 | 2 | 0,72 | 32 | 32 | 23,04 | 1.024 | EPAL | 80 x 120 x 75h |



PEZZI SPECIALI. TRIMS

| | PCS/BOX | MQ/BOX | KG/BOX | PACKING | PACKING SIZE |
|---|---------|--------|--------|---------|--------------|
| 8,8 mm | | | | | |
| BATTISCOPA 9,5 x 60 | 12 | - | 15 | EPAL | 80 x 120 |
| GRADINO COSTA RETTA 33 x 60 x 3,2h ** | 4 | - | 23 | EPAL | 80 x 120 |
| GRADINO COSTA RETTA 33 x 60 x 3,2h R11 ** | 4 | - | 23 | EPAL | 80 x 120 |
| GRADINO COSTA RETTA 33 x 60 x 3,2h SX/DX ** | 4 | - | 24 | EPAL | 80 x 120 |
| GRADINO COSTA RETTA 33 x 60 x 3,2h SX/DX R11 ** | 4 | - | 24 | EPAL | 80 x 120 |
| ELLE MONOLITICO ESTRUSO 15 x 30 x 4H ** | 8 | - | 10,4 | EPAL | 80 x 120 |
| 20 mm | | | | | |
| GRADONE 15 x 60 ** | 1 | - | 4,5 | EPAL | 80 x 120 |
| GRADONE 15 x 60 SX/DX ** | 1 | - | 3,8 | EPAL | 80 x 120 |
| GRADONE 30 x 60 ** | 1 | - | 9 | EPAL | 80 x 120 |
| GRADONE 30 x 60 SX/DX ** | 1 | - | 6,6 | EPAL | 80 x 120 |
| GRIGLIA 15 x 60 ** | 1 | - | 4,2 | EPAL | 80 x 120 |
| GRIGLIA 15 x 60 SX/DX ** | 1 | - | 3,6 | EPAL | 80 x 120 |
| GRIGLIA 30 x 60 ** | 1 | - | 8,4 | EPAL | 80 x 120 |
| GRIGLIA 30 x 60 SX/DX ** | 1 | - | 7,2 | EPAL | 80 x 120 |

** A disposizione solo su richiesta.

Tempi di consegna: 30gg

Available upon request only.

Delivery terms: 30 days

Disponible seulement sur requête.

Délais de livraison: 30 jours

Verfügbar auf Anfrage.

Lieferzeit: 30 Tage

La gamma completa dei pezzi speciali è disponibile nella "PARTE TECNICA" del catalogo a pag. 537

Our entire range of trims is available in our "TECHNICAL SECTION" of this catalogue pag. 537.

La gamme complète des pièces spéciales est disponible dans la section "PARTIE TECHNIQUE" à la pag. 537 de ce catalogue.

Das komplette Sortiment an Sonderstücken ist in dem "technischen Teil" des Katalogs auf Seite 537 verfügbar.



*Borghini
Italiani*

MARMO E PIETRA

GRAFITE

AGATA

CENERE

SILICE

CALCE

8,8 mm



40,6x60,9
16"x24"
Nat R11C



40,6x40,6
16"x16"
Nat R11C



20,3x40,6
8"x16"
Nat R11C



20,3x20,3
8"x8"
Nat R11C

modular system



Gres Porcellanato. Porcelain tiles
Grès cérame. Feinsteinzeug
ISO 13006 - G - Bla_E ≤ 0,5%
UNI EN 14411

ANSI A - 326.3: 2021
W E T D Y N A M I C
COEFFICIENT OF FRICTION

DCOF ≥ 0,42

Borghesi Italiani
MARMO E PIETRA

100% DESIGN AND PRODUCTION OF ITALY

Sviluppo grafico per formato
Pattern by size
Développement graphique par format
Grafischer Entwurf für Format

40,6x60,9
8,8 mm

15

40,6x40,6
8,8 mm

27

20,3x40,6
8,8 mm

60

20,3x20,3
8,8 mm

56

Sviluppo Grafico e Modularità

Pattern by size and modular system. Développement graphique par format et système modulaire. Grafische Entwicklung und Modularität.

Borghi Italiani

AGATA 8,8 mm



40,6x60,9
16"x24"
33,5%

40,6x40,6
16"x16"
44,5%

20,3x40,6
8"x16"
11%

20,3x20,3
8"x8"
11%

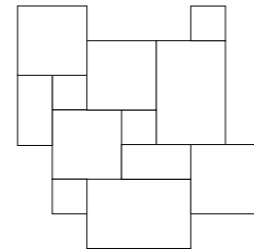

8,8 mm

| | 40,6x60,9 16"x24" | 40,6x40,6 16"x16" | 20,3x40,6 8"x16" | 20,3x20,3 8"x8" |
|------------|----------------------|----------------------|---------------------|--------------------|
| | Nat R11C | Nat R11C | Nat R11C | Nat R11C |
| GRAFITE | 162014 | 162024 | 162034 | 162044 |
| AGATA | 162012 | 162022 | 162032 | 162042 |
| CENERE | 162011 | 162021 | 162031 | 162041 |
| SILICE | 162013 | 162023 | 162033 | 162043 |
| CALCE | 162010 | 162020 | 162030 | 162040 |
| Price code | M083 | M083 | M083 | M083 |

Pezzi Speciali / Trims. Pièces speciale. Die Sonderstücke

| 8,8 mm | Battiscopa Skirting | Gradino costa retta** Straight-edge stair** | Gradino costa retta SX-DX** Straight-edge step L-R | 8,8 mm R11C Elle monolitico estruso** Extruded L-shaped monoblock tile |
|------------|------------------------|--|---|---|
| | 7x60,9 | 33x60,9 | 33x60,9 | 15x30x4 |
| | Nat R11C | Nat R11C | Nat R11C | Nat R11C |
| GRAFITE | 162105 | 162205 | 162225 SX 162215 DX | 162415 |
| AGATA | 162103 | 162203 | 162223 SX 162213 DX | 162413 |
| CENERE | 162102 | 162202 | 162222 SX 162212 DX | 162412 |
| SILICE | 162104 | 162204 | 162224 SX 162214 DX | 162414 |
| CALCE | 162101 | 162201 | 162221 SX 162211 DX | 162411 |
| Price code | P021 | P135 | P167 | P050 |

Calpestio. Foot traffic

• GRAFITE LOW • AGATA, SILICE MEDIUM • CENERE, CALCE HIGH

Imballi / Packings. Emballage. Verpackung

| 8,8 mm | PCS/BOX | MQ/BOX | KG/BOX | BOX/PAL | MQ/PAL | KG/PAL | PACKING | PACKING SIZE |
|-------------|---------|--------|--------|---------|--------|--------|---------|----------------|
| 40,6 x 60,9 | 6 | 1,48 | 30 | 40 | 59,20 | 1.200 | EPAL | 80 x 120 x 96h |
| 40,6 x 40,6 | 6 | 0,99 | 17,2 | 72 | 71,28 | 1.238 | EPAL | 80 x 120 x 96h |
| 20,3 x 40,6 | 13 | 1,07 | 18,3 | 72 | 77,04 | 1.323 | EPAL | 80 x 120 x 96h |
| 20,3 x 20,3 | 30 | 1,24 | 21,8 | 60 | 74,40 | 1.307 | EPAL | 80 x 120 x 96h |

| 8,8 mm | PCS/BOX | MQ/BOX | KG/BOX | BOX/PAL | MQ/PAL | KG/PAL | PACKING | PACKING SIZE |
|--|---------|--------|--------|---------|--------|--------|---------|----------------|
| BATTISCOPA 7 x 60,9 | 15 | 0,63 | 13,7 | - | - | - | EPAL | 80 x 120 |
| GRADINO COSTA RETTA 33 x 60,9 x 3,2h** | 4 | - | 20 | - | - | - | EPAL | 80 x 120 |
| GRADINO COSTA RETTA 33 x 60,9 x 3,2h SX/DX** | 2 | - | 11 | - | - | - | EPAL | 80 x 120 |
| ELLE MONOLITICO ESTRUSO 15 x 30 x 4h** | 8 | 0,32 | 8,2 | 36 | 11,52 | 298 | EPAL | 80 x 120 x 75h |



** A disposizione solo su richiesta.
Tempi di consegna: 30gg
Available upon request only.
Delivery terms: 30 days
Disponible seulement sur requête.
Délais de livraison: 30 jours
Verfügbar auf Anfrage.
Lieferzeit: 30 Tage

Materico

| | |
|---------------------|-----|
| Skyline | 305 |
| Hurban | 313 |
| Absolute | 321 |
| Le Malte | 327 |
| Space | 335 |
| Artile | 343 |
| Lascaux | 351 |
| Cotto del Casale | 357 |
| Kist NEW | 365 |
| Kist Lux NEW | 373 |
| Grooves NEW | 381 |
| Up | 389 |
| Small | 399 |



Skyline

MATERICO

ANTRACITE

FUMO

GHIACCIO

BEIGE



Gres Porcellanato. Porcelain tiles
Grès cérame. Feinsteinzeug
ISO 13006 - G - Bla_E ≤ 0,5%
UNI EN 14411

ANSI A - 326.3: 2021
W E T D Y N A M I C
COEFFICIENT OF FRICTION

DCOF ≥ 0,42

6 mm



160x320
63"x126"
Nat Ret

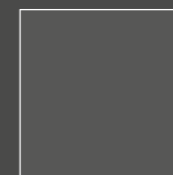

160x160
63"x63"
Nat Ret



80x160
31 1/2"x63"
Nat Ret



80x80
31 1/2"x31 1/2"
Nat Ret

modular system

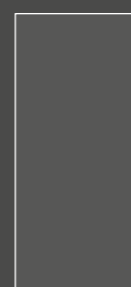

120x280
48"x110"
Nat Ret



120x120
48"x48"
Nat Ret

modular system

Decoro / Decor



Mosaico 30x30
12"x12"
Nat Ret

8,8 mm



100x100
40"x40"
Nat Ret



60x120
24"x48"
Nat Ret



60x60
24"x24"
Nat Ret

modular system

8,8 mm



100x100
40"x40"
Nat Ret **R11C**

20 mm OUTDOOR



100x100
40"x40"
Nat Ret **R11C**

Skyline
MATERICO

100% DESIGN AND PRODUCTION OF ITALY

Sviluppo grafico per formato
Pattern by size
Développement graphique par format
Grafischer Entwurf für Format

| | | | | | | | | |
|-----------------|-----------------|----------------|---------------|-----------------|-----------------|----------------------------|------------------|-----------------|
| 160x320 6 mm | 160x160 6 mm | 80x160 6 mm | 80x80 6 mm | 120x280 6 mm | 120x120 6 mm | 100x100 8,8 mm 20 mm | 60x120 8,8 mm | 60x60 8,8 mm |
| 7 | 14 | 28 | 56 | 11 | 22 | 14 | 23 | 56 |

GHIACCIO 160x320 6 mm

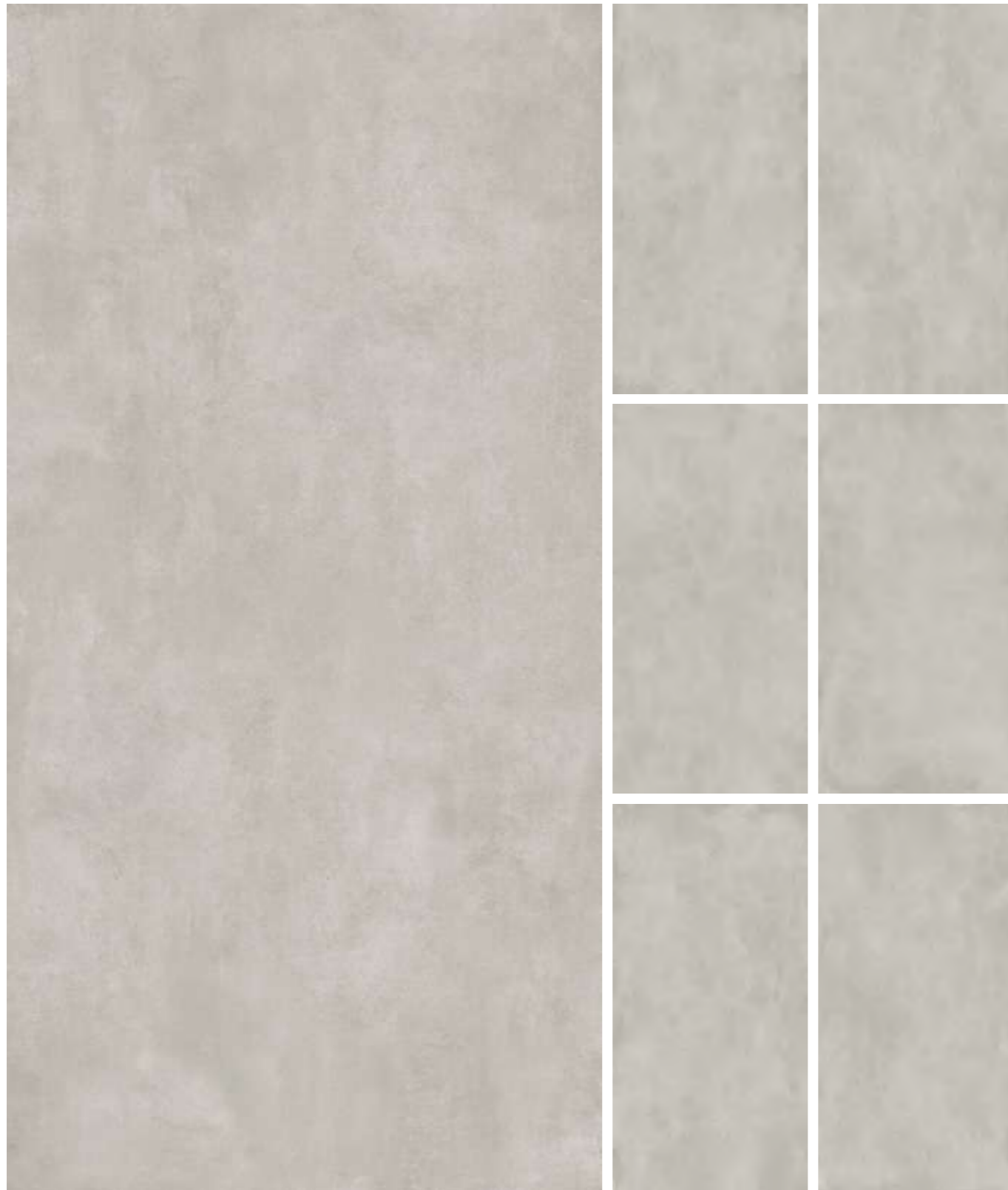

7 PATTERNS

6 mm

| | 160x320 63"x126" | 160x160 63"x63" | 80x160 31 1/2"x63" | 80x80 31 1/2"x31 1/2" | 120x280 48"x110" | 120x120 48"x48" | Mosaico 30x30 12"x12" |
|-------------|---------------------|--------------------|-----------------------|--------------------------|---------------------|--------------------|--------------------------|
| | Nat Ret | Nat Ret | Nat Ret | Nat Ret | Nat Ret | Nat Ret | Nat Ret |
| ANTRACITE ● | 082010 | 082050 | 082090 | 082110 | 082040 | 082070 | 082189 |
| FUMO ● | 082007 | 082047 | 082087 | 082107 | 082037 | 082067 | 082185 |
| GHIACCIO ● | 082001 | 082041 | 082081 | 082101 | 082031 | 082061 | 082181 |
| BEIGE ● | 082004 | 082044 | 082084 | 082104 | 082034 | 082064 | 082183 |
| Price code | M173 | M161 | M141 | M129 | M153 | M141 | M193 |

8,8 mm

| | 100x100 40"x40" | 60x120 24"x48" | 60x60 24"x24" | | 100x100 40"x40" | 20 mm | 100x100 40"x40" |
|-------------|--------------------|-------------------|------------------|-------------|---------------------|-------------|---------------------|
| | Nat Ret | Nat Ret | Nat Ret | | Nat Ret R11C | | Nat Ret R11C |
| ANTRACITE ● | 082094 | 082130 | 082150 | ANTRACITE ● | 082098 | ANTRACITE ● | 082114 |
| FUMO ● | 082091 | 082127 | 082147 | FUMO ● | 082095 | FUMO ● | 082111 |
| GHIACCIO ● | 082093 | 082121 | 082141 | GHIACCIO ● | 082097 | GHIACCIO ● | 082113 |
| BEIGE ● | 082092 | 082124 | 082144 | BEIGE ● | 082096 | BEIGE ● | 082112 |
| Price code | M109 | M109 | M089 | Price code | M109 | Price code | M143 |

Imballi / Packings. Emballage. Verpackung

| | PCS/BOX | MQ/BOX | KG/BOX | PCS/PAL | BOX/PAL | MQ/PAL | KG/PAL | PACKING | PACKING SIZE | TARE (KG) |
|-----------------|---------|--------|--------|---------|---------|--------|--------|------------------|-----------------------|-----------|
| 6 mm | | | | | | | | | | |
| 160 x 320 | - | - | - | 14 | - | 71,68 | 1.039 | CASSA | 345 x 175 x 37h | 140 |
| | - | - | - | 44 | - | 225,28 | 3.162 | CAVALLETTO LEGNO | 330 x 75 x 193,5h | 177,50 |
| 160 x 160 | - | - | - | 24 | - | 61,44 | 970 | CASSA | 182,6 x 173,6 x 40,4h | 80 |
| 80 x 160 | 2 | 2,56 | 37,2 | - | 15 | 38,40 | 557 | PALLET SPECIALE | 168 x 97 x 40,9h | 29 |
| 80 x 80 | 3 | 1,92 | 28,2 | - | 40 | 76,80 | 1.130 | EPAL | 80 x 120 | 22 |
| 120 x 280 | - | - | - | 20 | - | 67,20 | 974 | CASSA | 292 x 145 x 35h | 108 |
| | - | - | - | 44 | - | 147,84 | 2.140 | CAVALLETTO LEGNO | 290 x 75 x 161h | 145 |
| 120 x 120 | 2 | 2,88 | 41,7 | - | 24 | 69,12 | 1.002 | PALLET SPECIALE | 123x143x74h | 29 |
| MOSAICO 30 x 30 | 9 | 0,81 | 11,8 | - | 60 | 48,60 | 709 | EPAL | 80 x 120 | 22 |
| 8,8 mm | | | | | | | | | | |
| 60 x 120 | 2 | 1,44 | 27 | - | 32 | 46,08 | 864 | EPAL | 80 x 120 | 22 |
| 60 x 60 | 3 | 1,08 | 19,8 | - | 40 | 43,20 | 794 | EPAL | 80 x 120 | 22 |
| 100 x 100 | 2 | 2 | 38,1 | - | 24 | 48 | 916 | PALLET SPECIALE | 103 x 123 x 70h | 30 |
| 20 mm | | | | | | | | | | |
| 100 x 100 | 1 | 1 | 44,2 | - | 24 | 24 | 1.060 | PALLET | 103 x 103 x 65h | 22 |



Cavalletto in legno
Wood A-Frame. Support en bois.
Holzgestell



Cassa
Crate. Caisse. Kiste



Pallet speciale con sponde
Special pallet with sides.
Palette spéciale avec bords.
Spezial-Palette mit Wandungen.



Epal / Pallet

Pezzi Speciali / Trims. Pièces speciale. Die Sonderstücke

6 mm



Battiscopa
Skirting

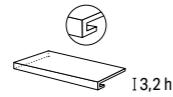

Gradino costa retta**
Straight-edge stair**

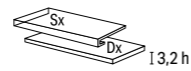

Gradino costa retta SX - DX**
Straight-edge step L-R corner**

| | 8x80 | | 33x160 | | 33x120 | |
|------------|---------|--------|---------|------------------------|------------------------|--|
| | Nat Ret | | Nat Ret | | Nat Ret | |
| ANTRACITE | 082204 | 082244 | 082252 | 082308 SX 082276 DX | 082316 SX 082284 DX | |
| FUMO | 082203 | 082207 | 082251 | 082307 SX 082275 DX | 082315 SX 082283 DX | |
| GHIACCIO | 082201 | 082205 | 082249 | 082305 SX 082273 DX | 082313 SX 082281 DX | |
| BEIGE | 082202 | 082206 | 082250 | 082306 SX 082274 DX | 082314 SX 082282 DX | |
| Price code | P029 | P303 | P243 | P319 | P273 | |

8,8 mm



Battiscopa
Skirting

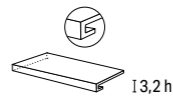

Gradino costa retta**
Straight-edge stair**

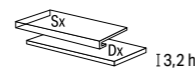

Gradino costa retta SX - DX**
Straight-edge step L-R corner**

| | 6,5x120 | | 7x100 | | 33x120 | | 33x100 | |
|------------|---------|--------|---------|--------|------------------------|------------------------|---------|--|
| | Nat Ret | | Nat Ret | | Nat Ret | | Nat Ret | |
| ANTRACITE | 082212 | 082120 | 082268 | 082248 | 082332 SX 082300 DX | 082312 SX 082280 DX | | |
| FUMO | 082211 | 082117 | 082267 | 082245 | 082331 SX 082299 DX | 082309 SX 082277 DX | | |
| GHIACCIO | 082209 | 082119 | 082265 | 082247 | 082329 SX 082297 DX | 082311 SX 082279 DX | | |
| BEIGE | 082210 | 082118 | 082266 | 082246 | 082330 SX 082298 DX | 082310 SX 082278 DX | | |
| Price code | P040 | P035 | P207 | P207 | P231 | P219 | | |

8,8 mm

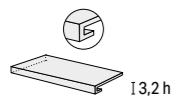

Gradino costa retta**
Straight-edge stair**

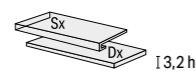

Gradino costa retta SX - DX**
Straight-edge step L-R corner**

| | 33x100 | | 33x100 | |
|------------|--------------|------------------------|--------------|--|
| | Nat Ret R11C | | Nat Ret R11C | |
| ANTRACITE | 082256 | 082320 SX 082288 DX | | |
| FUMO | 082253 | 082317 SX 082285 DX | | |
| GHIACCIO | 082255 | 082319 SX 082287 DX | | |
| BEIGE | 082254 | 082318 SX 082286 DX | | |
| Price code | P207 | P219 | | |

20 mm

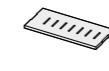

Griglia**
Drainage grid
20x100
R11C

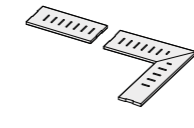

Griglia SX - DX**
Drainage grid L-R corner
20x100
R11C

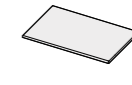

Gradone**
Large step
50x100
R11C

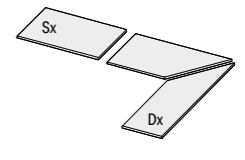

Gradone SX - DX**
Large step L-R corner
50x100
R11C

| | 20x100 R11C | | 20x100 R11C | | 50x100 R11C | | 50x100 R11C | |
|------------|-------------|------------------------|-------------|--------|------------------------|------------------------|-------------|--|
| | C | | C | | C | | C | |
| ANTRACITE | 082664 | 082672 SX 082668 DX | 082616 | 082604 | 082624 SX 082620 DX | 082612 SX 082608 DX | | |
| FUMO | 082661 | 082669 SX 082665 DX | 082613 | 082601 | 082621 SX 082617 DX | 082609 SX 082605 DX | | |
| GHIACCIO | 082663 | 082671 SX 082667 DX | 082615 | 082603 | 082623 SX 082619 DX | 082611 SX 082607 DX | | |
| BEIGE | 082662 | 082670 SX 082666 DX | 082614 | 082602 | 082622 SX 082618 DX | 082610 SX 082606 DX | | |
| Price code | P291 | P291 | P235 | P225 | P253 | P245 | | |



Costa toro.
Bullnose edge.
Bord boudin.
Abgerundete Kante.



Costa retta.
Straight edge.
Bord droit.
Gerade Kante.

La gamma completa dei pezzi speciali è disponibile nella "PARTE TECNICA" del catalogo a pag. 537

Our entire range of trims is available in our "TECHNICAL SECTION" of this catalogue pag. 537.

La gamme complète des pièces spéciales est disponible dans la section "PARTIE TECHNIQUE" à la pag. 537 de ce catalogue.

Das komplette Sortiment an Sonderstücken ist in dem "technischen Teil" des Katalogs auf Seite 537 verfügbar.

Calpestio. Foot traffic

• ANTRACITE LOW • FUMO MEDIUM • GHIACCIO, BEIGE HIGH

Imballi / Packings. Emballage. Verpackung

| PEZZI SPECIALI. TRIMS. | PCS/BOX | MQ/BOX | KG/BOX | PACKING | PACKING SIZE |
|--|---------|--------|--------|-----------------|------------------|
| 6 mm | | | | | |
| BATTISCOPA 8 x 80 | 12 | 0,77 | 11,50 | PALLET | 80 x 120 |
| GRADINO COSTA RETTA 33 x 160 x 3,2h ** | 1 | - | 9 | PALLET SPECIALE | 168 x 97 x 40,9h |
| GRADINO COSTA RETTA 33 x 160 x 3,2h SX/DX ** | 1 | - | 10 | PALLET SPECIALE | 168 x 97 x 40,9h |
| GRADINO COSTA RETTA 33 x 120 x 3,2h ** | 2 | - | 14 | PALLET | 80 x 120 |
| GRADINO COSTA RETTA 33 x 120 x 3,2h SX/DX ** | 1 | - | 7 | PALLET | 80 x 120 |
| 8,8 mm | | | | | |
| BATTISCOPA 6,5 x 120 | 6 | - | 11,40 | PALLET | 80 x 120 |
| BATTISCOPA 7 x 100 | 6 | - | 9 | PALLET | 103 x 103 |
| GRADINO COSTA RETTA 33 x 120 x 3,2h ** | 2 | - | 22 | PALLET | 80 x 120 |
| GRADINO COSTA RETTA 33 x 120 x 3,2h SX/DX ** | 1 | - | 11 | PALLET | 80 x 120 |
| GRADINO COSTA RETTA 33 x 100 x 3,2h ** | 2 | - | 14 | PALLET | 103 x 103 |
| GRADINO COSTA RETTA 33 x 100 x 3,2h SX/DX ** | 1 | - | 9 | PALLET | 103 x 103 |
| 20 mm | | | | | |
| GRADONE 50 x 100 ** | 1 | - | 15 | PALLET | 103 x 103 |
| GRADONE 50 x 100 SX/DX ** | 1 | - | 15 | PALLET | 103 x 103 |
| GRIGLIA 20 x 100 ** | 1 | - | 8 | PALLET | 103 x 103 |
| GRIGLIA 20 x 100 SX/DX ** | 1 | - | 8 | PALLET | 103 x 103 |



Pallet speciale con sponde
Special pallet with sides.
Palette spéciale avec bords.
Spezial-Palette mit Wandungen.



Pallet

** A disposizione solo su richiesta. Tempi di consegna: 30gg
Available upon request only. Delivery terms: 30 days
Disponible seulement sur requête. Délais de livraison: 30 jours
Verfügbar auf Anfrage. Lieferzeit: 30 Tage



Hurban

MATERICO

GRAPHITE

GRAY

AVIO

WHITE

BEIGE

OCRA



Gres Porcellanato. Porcelain tiles
Grès cérame. Feinsteinzeug
ISO 13006 - G - Bla_E ≤ 0,5%
UNI EN 14411

ANSI A - 326.3: 2021
W E T D Y N A M I C
COEFFICIENT OF FRICTION

DCOF ≥ 0,42

6 mm



120x280
48"x110"
Nat Ret

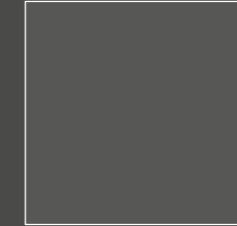

120x120
48"x48"
Nat Ret

Graphite
Gray
White
Beige

8,8 mm



100x100
40"x40"
Nat Ret **R10B**



60x120
24"x48"
Nat Ret **R10B**



60x60
24"x24"
Nat Ret **R10B**



30x60
12"x24"
Nat Ret **R10B**

modular system

Decori / Decors



Mosaico 30x30
12"x12"
Nat Ret **R10B**



Spaccatella 30x30
12"x12"
Nat Ret **R10B**



Quadrotto Intarsio 30x30
12"x12"
Nat Ret **R10B**

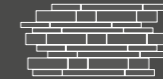

Muretto 30x60
12"x24"
Nat Ret **R10B**

8,8 mm



100x100
40"x40"
Nat Ret **R11C**

Gray
White
Beige

20 mm OUTDOOR



100x100
40"x40"
Nat Ret **R11C**

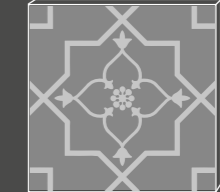

100x100
40"x40"
Nat Ret **R11C**

Gray
Beige

Hurban

MATERICO

100% DESIGN AND PRODUCTION OF ITALY

Sviluppo grafico per formato
Pattern by size
Développement graphique par format
Grafischer Entwurf für Format

| | | | | | | |
|-----------------|-----------------|-------------------|------------------|-----------------|-----------------|------------------|
| 120x280 6 mm | 120x120 6 mm | 100x100 8,8 mm | 60x120 8,8 mm | 60x60 8,8 mm | 30x60 8,8 mm | 100x100 20 mm |
| 4 | 8 | 10 | 17 | 34 | 68 | 10 |

Sviluppo Grafico

Pattern by size. Développement graphique par format. Grafischer Entwurf für Format

WHITE 120x280 6 mm

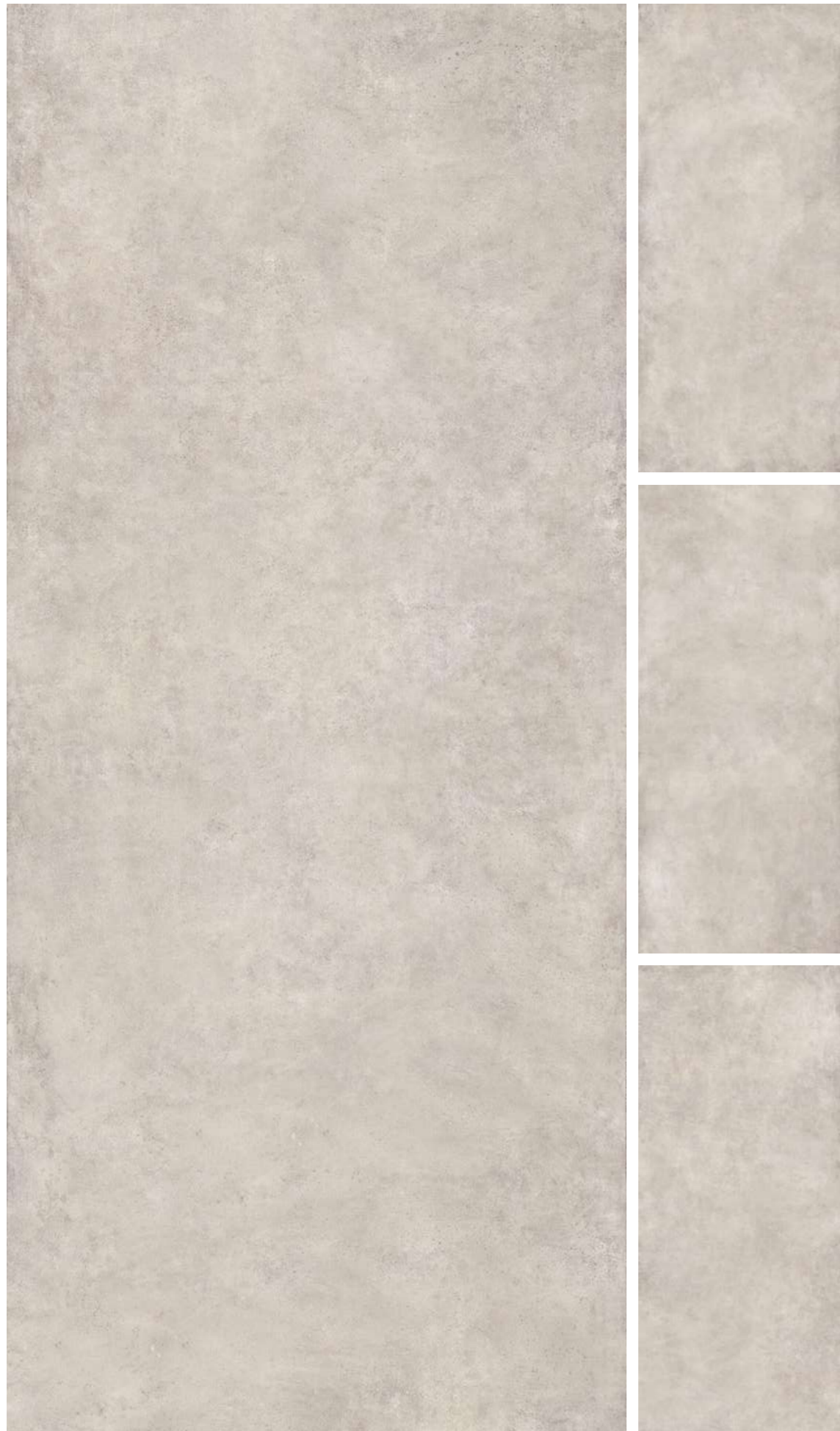

4 PATTERNS

Decori

Decors

8,8 mm

GRAPHITE

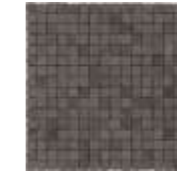

GRAY

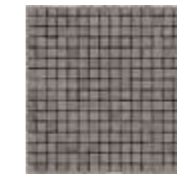
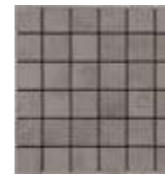

AVIO

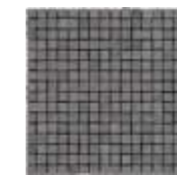
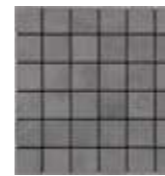

WHITE

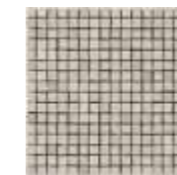

BEIGE

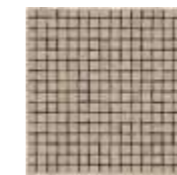

OCRA

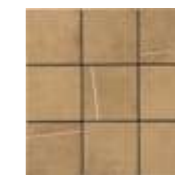

Mosaico 30x30
12"x12"
Nat Ret **[R10B]**

Spaccatella 30x30
12"x12"
Nat Ret **[R10B]**

Quadrotto Intarsio 30x30
12"x12"
Nat Ret **[R10B]**

Muretto 30x60
12"x24"
Nat Ret **[R10B]**

20 mm OUTDOOR

BEIGE

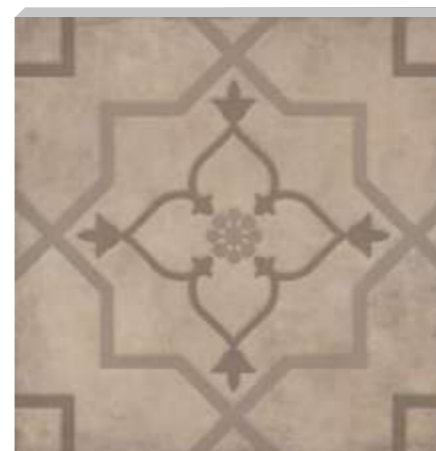

Queens 100x100
40"x40"
Nat Ret **[R11C]**

GRAY



Queens 100x100
40"x40"
Nat Ret **[R11C]**

Hurban

6 mm

| | 120x280 48"x110" | 120x120 48"x48" |
|-------------------|---------------------|--------------------|
| | Nat Ret | Nat Ret |
| GRAPHITE | 177084 | 177094 |
| GRAY | 177083 | 177093 |
| AVIO | 177085 | - |
| WHITE | 177081 | 177091 |
| BEIGE | 177082 | 177092 |
| OCRA | 177086 | - |
| Price code | M153 | M141 |

8,8 mm

| | 100x100 40"x40" | 60x120 24"x48" | 60x60 24"x24" | 30x60 12"x24" |
|-------------------|-----------------------|-----------------------|-----------------------|-----------------------|
| | Nat Ret [R10B] | Nat Ret [R10B] | Nat Ret [R10B] | Nat Ret [R10B] |
| GRAPHITE | 177054 | 177004 | 177014 | 177024 |
| GRAY | 177053 | 177003 | 177013 | 177023 |
| AVIO | 177055 | 177005 | 177015 | 177025 |
| WHITE | 177051 | 177001 | 177011 | 177021 |
| BEIGE | 177052 | 177002 | 177012 | 177022 |
| OCRA | 177056 | 177006 | 177016 | 177026 |
| Price code | M109 | M097 | M089 | M081 |

20 mm

| | Gradone** Large step 50x100 | Gradone Angolo Sx/Dx** Large step - Corner L/R 50x100 |
|-------------------|-------------------------------------|---|
| | Costa toro Nat Ret [R11C] | Costa toro Nat Ret [R11C] |
| GRAPHITE | 177414 | 177417 SX 177423 DX |
| GRAY | 177413 | 177418 SX 177424 DX |
| AVIO | 177415 | 177419 SX 177425 DX |
| WHITE | 177411 | 177420 SX 177426 DX |
| BEIGE | 177412 | 177421 SX 177427 DX |
| OCRA | 177416 | 177422 SX 177428 DX |
| Price code | P235 | P253 |

20 mm

| | Griglia** Drainage grid 20x100 [R11C] | Griglia - Angolo Sx/Dx** Drainage grid - Corner L/R 20x100 [R11C] |
|-------------------|---|---|
| GRAPHITE | 177454 | 177457 SX 177463 DX |
| GRAY | 177453 | 177458 SX 177464 DX |
| AVIO | 177455 | 177459 SX 177465 DX |
| WHITE | 177451 | 177460 SX 177466 DX |
| BEIGE | 177452 | 177461 SX 177467 DX |
| OCRA | 177456 | 177462 SX 177468 DX |
| Price code | P291 | P291 |

8,8 mm

| | Mosaico 30x30 12"x12" | Spaccatella 30x30 12"x12" | Quadrotto Intarsio 30x30 12"x12" | Muretto 30x60 12"x24" | 100x100 40"x40" | 100x100 40"x40" |
|-------------------|-----------------------------|---------------------------------|--|-----------------------------|-----------------------|-----------------------|
| | Nat Ret [R10B] | Nat Ret [R10B] | Nat Ret [R10B] | Nat Ret [R10B] | Nat Ret [R11C] | Nat Ret [R11C] |
| GRAPHITE | 177304 | 177314 | 177324 | 177334 | - | 177064 |
| GRAY | 177303 | 177313 | 177323 | 177333 | 177073 | 177063 |
| AVIO | 177305 | 177315 | 177325 | 177335 | - | 177065 |
| WHITE | 177301 | 177311 | 177321 | 177331 | 177071 | 177061 |
| BEIGE | 177302 | 177312 | 177322 | 177332 | 177072 | 177062 |
| OCRA | 177306 | 177316 | 177326 | 177336 | - | 177066 |
| Price code | M159 | M270 | M302 | M252 | M109 | M143 |

Calpestio . Foot traffic
 • GRAPHITE, AVIO LOW • GRAY, OCRA MEDIUM • WHITE, BEIGE HIGH

Pezzi Speciali / Trims. Pièces speciale. Die Sonderstücke

20 mm

Queens
100x100
40"x40"

| | Nat Ret [R11C] |
|-------------------|-----------------------|
| GRAPHITE | - |
| GRAY | 177403 |
| AVIO | - |
| WHITE | - |
| BEIGE | 177402 |
| OCRA | - |
| Price code | M153 |

8,8 mm

| | Battiscopa Skirting 7x100 | 7x60 | Gradino costa retta** Straight nosed stair** 33x120 | Gradino costa retta SX - DX** Straight-edge step L-R 33x120 |
|-------------------|---------------------------------|-----------------------|--|--|
| | Nat Ret [R10B] | Nat Ret [R10B] | Nat Ret [R10B] | Nat Ret [R10B] |
| GRAPHITE | 177104 | 177114 | 177204 | 177224 SX 177214 DX |
| GRAY | 177103 | 177113 | 177203 | 177223 SX 177213 DX |
| AVIO | 177105 | 177115 | 177205 | 177225 SX 177215 DX |
| WHITE | 177101 | 177111 | 177231 | 177241 SX 177211 DX |
| BEIGE | 177102 | 177112 | 177202 | 177222 SX 177212 DX |
| OCRA | 177106 | 177116 | 177206 | 177226 SX 177216 DX |
| Price code | P035 | P021 | P207 | P239 |

Imballi / Packings. Emballage. Verpackung

| | PCS/BOX | MQ/BOX | KG/BOX | PCS/PAL | BOX/PAL | MQ/PAL | KG/PAL | PACKING | PACKING SIZE |
|----------------------------|---------|--------|--------|---------|---------|--------|--------|-------------------|-----------------|
| 6 mm | | | | | | | | | |
| 120 x 280 | - | - | - | 20 | - | 67,20 | 974 | CASSA | 292 x 145 x 35h |
| | - | - | - | 44 | - | 147,84 | 2.140 | CAVALLETTO LEGNO | 290 x 75 x 161h |
| 120 x 120 | 2 | 2,88 | 41,7 | - | 24 | 69,12 | 1.002 | PALLET SPECIALE | 123x143x74h |
| 8,8 mm | | | | | | | | | |
| 100 x 100 | 2 | 2 | 36,3 | - | 24 | 48 | 872 | PALLET CON SPONDE | 103 x 123 x 70h |
| 100 x 100 R11C | 2 | 2 | 36,3 | - | 24 | 48 | 872 | PALLET CON SPONDE | 103 x 123 x 70h |
| 60 x 120 | 2 | 1,44 | 27,5 | - | 32 | 46,08 | 881 | EPAL | 80 x 120 x 75h |
| 60 x 60 | 3 | 1,08 | 20,5 | - | 40 | 43,20 | 823 | EPAL | 80 x 120 x 75h |
| 30 x 60 | 7 | 1,26 | 24 | - | 48 | 60,48 | 1.152 | EPAL | 80 x 120 x 75h |
| DECORI. DECORS | | | | | | | | | |
| MOSAICO 30 x 30 | 6 | 0,54 | 10,3 | 60 | 32,40 | 622 | EPAL | 80 x 120 | |
| SPACCATELLA 30 x 30 | 6 | 0,54 | 10,3 | 60 | 32,40 | 622 | EPAL | 80 x 120 | |
| QUADROTTO INTARSIO 30 x 30 | 6 | 0,54 | 10,3 | 60 | 32,40 | 622 | EPAL | 80 x 120 | |
| MURETTO 30 x 60 | 4 | 0,72 | 13,7 | 30 | 21,60 | 411 | EPAL | 80 x 120 | |
| 20 mm | | | | | | | | | |
| 100 x 100 R11C | 1 | 1 | 44,5 | 24 | 24 | 1.045 | 960 | PALLET CON SPONDE | 103 x 103 x 65h |
| DECORI. DECORS | | | | | | | | | |
| QUEENS 100 x 100 R11C | 1 | 1 | 40 | 24 | 24 | 960 | 960 | PALLET CON SPONDE | 103 x 103 x 65h |

Cavalletto in legno
Wood A-Frame.
Support en bois.
Holzgestell

Cassa
Crate . Caisse . Kiste

Pallet speciale con sponde
Special pallet with sides .
Palette spéciale avec bords.
Spezial-Palette mit Wandungen.

Epal

PEZZI SPECIALI. TRIMS

| | PCS/BOX | MQ/BOX | KG/BOX | PACKING | PACKING SIZE |
|---|---------|--------|--------|---------|--------------|
| 8,8 mm | | | | | |
| BATTISCOPA 7 x 100 | 6 | 0,42 | 8,10 | EPAL | 80 x 120 |
| BATTISCOPA 7 x 60 | 15 | 0,63 | 13,28 | EPAL | 80 x 120 |
| GRADINO COSTA RETTA 33 x 120 x 3,2h** | 2 | - | 20,70 | EPAL | 80 x 120 |
| GRADINO COSTA RETTA 33 x 120 x 3,2h SX/DX** | 1 | - | 10,80 | EPAL | 80 x 120 |
| 20 mm | | | | | |
| GRADONE 50 x 100** | 1 | - | 15 | PALLET | 103 x 103 |
| GRADONE 50 x 100 SX/DX** | 1 | - | 15 | PALLET | 103 x 103 |
| GRIGLIA 20 x 100** | 1 | - | 8 | PALLET | 103 x 103 |
| GRIGLIA 20 x 100 SX/DX** | 1 | - | 8 | PALLET | 103 x 103 |

La gamma completa dei pezzi speciali è disponibile nella "PARTE TECNICA" del catalogo a pag. 537
 Our entire range of trims is available in our "TECHNICAL SECTION" of this catalogue pag. 537.
 La gamme complète des pièces spéciales est disponible dans la section "PARTIE TECHNIQUE" à la pag. 537 de ce catalogue.
 Das komplette Sortiment an Sonderstücken ist in dem "technischen Teil" des Katalogs auf Seite 537 verfügbar.

**** A disposizione solo su richiesta. Tempi di consegna: 30gg**
 Available upon request only. Delivery terms: 30 days
 Disponible seulement sur requête. Délais de livraison: 30 jours
 Verfügbar auf Anfrage. Lieferzeit: 30 Tage

Absolute

MATERICO



BLACK

WHITE

6 mm



160x320
63"x126"
Nat Ret
Lap Ret

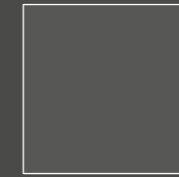

160x160
63"x63"
Nat Ret
Lap Ret



80x160
31 1/2"x63"
Nat Ret
Lap Ret



80x80
31 1/2"x31 1/2"
Nat Ret
Lap Ret

modular system



120x280
48"x110"
Nat Ret
Lap Ret



120x120
48"x48"
Nat Ret
Lap Ret

Decoro / Decor



Mosaico 30x30
12"x12"
Nat Ret
Lap Ret

8,8 mm



60x120
24"x48"
Nat Ret



60x60
24"x24"
Nat Ret

modular system

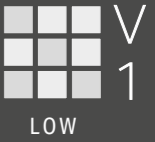

SHADE SPECTRUM

LOW

Gres Porcellanato. Porcelain tiles
Grès cérame. Feinsteinzeug
ISO 13006 - G - Bla_E ≤ 0,5%
UNI EN 14411

ANSI A - 326.3: 2021
W E T - D Y N A M I C
C O E F F I C I E N T O F F R I C T I O N

DCOF ≥ 0,42 | naturale

Absolute

MATERICO

100% DESIGN AND PRODUCTION OF ITALY

Absolute

6 mm

| | 160x320 63"x126" | | 160x160 63"x63" | | 80x160 31 1/2"x63" | | 80x80 31 1/2"x31 1/2" | | 120x280 48"x110" | | 120x120 48"x48" | | Mosaico 30x30 12"x12" | |
|------------|---------------------|---------|--------------------|---------|-----------------------|---------|--------------------------|---------|---------------------|---------|--------------------|---------|--------------------------|---------|
| | Nat Ret | Lap Ret | Nat Ret | Lap Ret | Nat Ret | Lap Ret | Nat Ret | Lap Ret | Nat Ret | Lap Ret | Nat Ret | Lap Ret | Nat Ret | Lap Ret |
| BLACK | 097005 | 097004 | 097035 | 097034 | 097056 | 097055 | 097066 | 097065 | 097015 | 097014 | 097045 | 097044 | 097123 | 097122 |
| WHITE | 097002 | 097001 | 097032 | 097031 | 097052 | 097051 | 097062 | 097061 | 097012 | 097011 | 097042 | 097041 | 097121 | 097120 |
| Price code | M181 | M205 | M169 | M193 | M155 | M179 | M133 | M148 | M163 | M185 | M151 | M177 | M193 | M235 |

8,8 mm

| | 60x120 24"x48" | 60x60 24"x24" |
|------------|-------------------|------------------|
| | Nat Ret | Nat Ret |
| BLACK | 097085 | 097095 |
| WHITE | 097081 | 097091 |
| Price code | M121 | M109 |



Furniture
Absolute Black Nat

Floor
Absolute White 120x120_48"x48" Nat Ret

Calpestio . Foot traffic

• BLACK LOW • WHITE HIGH

Pezzi Speciali / Trims. Pièces speciale. Die Sonderstücke

6 mm

| | Battiscopa Skirting | | Gradino costa retta** Straight-edge stair** | | Gradino costa retta SX - DX** Straight-edge step L-R corner** | | | | | |
|------------|------------------------|---------|--|---------|--|---------|------------------------|------------------------|------------------------|------------------------|
| | 8x80 | | 33x160 | | 33x120 | | 33x160 | | 33x120 | |
| | Nat Ret | Lap Ret | Nat Ret | Lap Ret | Nat Ret | Lap Ret | Nat Ret | Lap Ret | Nat Ret | Lap Ret |
| BLACK | 097119 | 097118 | 097224 | 097222 | 097228 | 097226 | 097218 SX 097220 DX | 097214 SX 097216 DX | 097266 SX 097264 DX | 097250 SX 097230 DX |
| WHITE | 097116 | 097115 | 097223 | 097221 | 097227 | 097225 | 097217 SX 097219 DX | 097210 SX 097215 DX | 097265 SX 097263 DX | 097249 SX 097229 DX |
| Price code | P029 | P039 | P303 | P323 | P243 | P265 | P319 | P339 | P273 | P283 |

8,8 mm

| | Battiscopa Skirting | Gradino costa retta** Straight-edge stair** | Gradino costa retta SX - DX** Straight-edge step L-R corner** |
|------------|------------------------|--|--|
| | 6,5x120 | 33x120 | 33x120 |
| | Nat Ret | Nat Ret | Nat Ret |
| BLACK | 097111 | 097268 | 097272 SX 097270 DX |
| WHITE | 097110 | 097267 | 097271 SX 097269 DX |
| Price code | P040 | P207 | P231 |

Imballi / Packings. Emballage. Verpackung

| | PCS/BOX | MQ/BOX | KG/BOX | PCS/PAL | BOX/PAL | MQ/PAL | KG/PAL | PACKING | PACKING SIZE | TARE (KG) |
|-----------------|---------|--------|--------|---------|---------|--------|--------|------------------|-----------------------|-----------|
| 6 mm | | | | | | | | | | |
| 160 x 320 | - | - | - | 14 | - | 71,68 | 1.039 | CASSA | 345 x 175 x 37h | 140 |
| | - | - | - | 44 | - | 225,28 | 3.262 | CAVALLETTO LEGNO | 330 x 75 x 193,5h | 177,5 |
| 160 x 160 | - | - | - | 24 | - | 61,44 | 970 | CASSA | 182,6 x 173,6 x 40,4h | 80 |
| 80 x 160 | 2 | 2,56 | 37,2 | - | 15 | 38,40 | 557 | PALLET SPECIALE | 168 x 97 x 40,9h | 29,4 |
| 80 x 80 | 3 | 1,92 | 27,9 | - | 40 | 76,80 | 1.120 | EPAL | 80 x 120 | 22 |
| | - | - | - | 20 | - | 67,20 | 975 | CASSA | 292 x 145 x 35h | 108 |
| 120 x 280 | - | - | - | 44 | - | 147,84 | 2.140 | CAVALLETTO LEGNO | 290 x 75 x 161h | 145 |
| 120 x 120 | 2 | 2,88 | 41,7 | - | 24 | 69,12 | 1.002 | PALLET SPECIALE | 123x143x74h | 29 |
| MOSAICO 30 x 30 | 9 | 0,81 | 11,8 | - | 60 | 48,60 | 709 | EPAL | 80 x 120 | 22 |
| 8,8 mm | | | | | | | | | | |
| 60 x 120 | 2 | 1,44 | 27,9 | - | 30 | 43,20 | 837 | EPAL | 80 x 120 | 22 |
| 60 x 60 | 3 | 1,08 | 21 | - | 40 | 43,20 | 840 | EPAL | 80 x 120 | 22 |



Cavalletto in legno
Wood A-Frame. Support en bois.
Holzgestell



Cassa
Crate . Caisse . Kiste



Pallet speciale con sponde
Special pallet with sides .
Palette spéciale avec bords.
Spezial-Palette mit Wandungen.



Epal / Pallet

| PEZZI SPECIALI. TRIMS. | PCS/BOX | MQ/BOX | KG/BOX | PACKING | PACKING SIZE |
|---|---------|--------|--------|-----------------|------------------|
| 6 mm | | | | | |
| BATTISCOPIA 8 x 80 | 12 | 0,77 | 11,50 | PALLET | 80 x 120 |
| GRADINO COSTA RETTA 33 x 160 x 3,2h ** | 1 | - | 9 | PALLET SPECIALE | 168 x 97 x 40,9h |
| GRADINO COSTA RETTA 33 x 160 x 3,2h SX/DX** | 1 | - | 10 | PALLET SPECIALE | 168 x 97 x 40,9h |
| GRADINO COSTA RETTA 33 x 120 x 3,2h ** | 2 | - | 14 | PALLET | 80 x 120 |
| GRADINO COSTA RETTA 33 x 120 x 3,2h SX/DX** | 1 | - | 7 | PALLET | 80 x 120 |
| 8,8 mm | | | | | |
| BATTISCOPIA 6,5 x 120 | 6 | - | 11,40 | PALLET | 80 x 120 |
| GRADINO COSTA RETTA 33 x 120 x 3,2h ** | 2 | - | 22 | PALLET | 80 x 120 |
| GRADINO COSTA RETTA 33 x 120 x 3,2h SX/DX** | 1 | - | 11 | PALLET | 80 x 120 |

** A disposizione solo su richiesta. Tempi di consegna: 30gg
Available upon request only. Delivery terms: 30 days
Disponible seulement sur requête. Délais de livraison: 30 jours
Verfügbar auf Anfrage. Lieferzeit: 30 Tage

glow
boutique

Le Malte
MATERICO

GREY

TAUPE

BEIGE

IVORY

SAGE

AVIO

6 mm



120x280
48"x110"
Nat Ret



120x120
48"x48"
Nat Ret



60x120
24"x48"
Nat Ret

8,8 mm



80x80
31 1/2"x31 1/2"
Nat Ret

Ivory
Beige
Grey
Taupe

La struttura e il tono tra i fondi di spessore 6mm e 8,8mm potrebbero presentare differenze.
The structure and shade of the tiles with 6 mm and 8.8 mm thickness could show differences.
La structure et la teinte des carreaux de 6 mm et 8,8 mm d'épaisseur peuvent présenter des différences.
Die Struktur und der Farbton der Fliesen mit einer Dicke von 6 mm und 8,8 mm könnten Unterschiede aufweisen.



LOW



SHADE SPECTRUM

Gres Porcellanato. Porcelain tiles
Grès cérame. Feinsteinzeug
ISO 13006 - G - Bla_E ≤ 0,5%
UNI EN 14411

ANSI A - 326.3: 2021
W E T D Y N A M I C
COEFFICIENT OF FRICTION

DCOF ≥ 0,42

Le Malte

MATERICO

100% DESIGN AND PRODUCTION OF ITALY

Le Malte

120x280 6mm

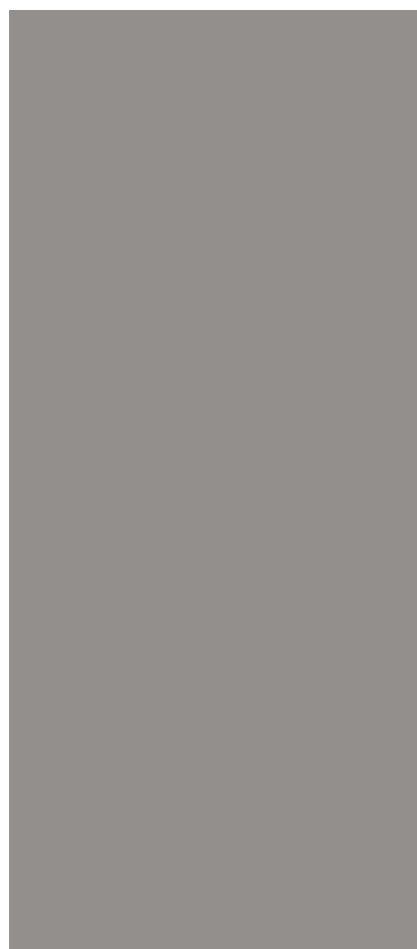

GREY

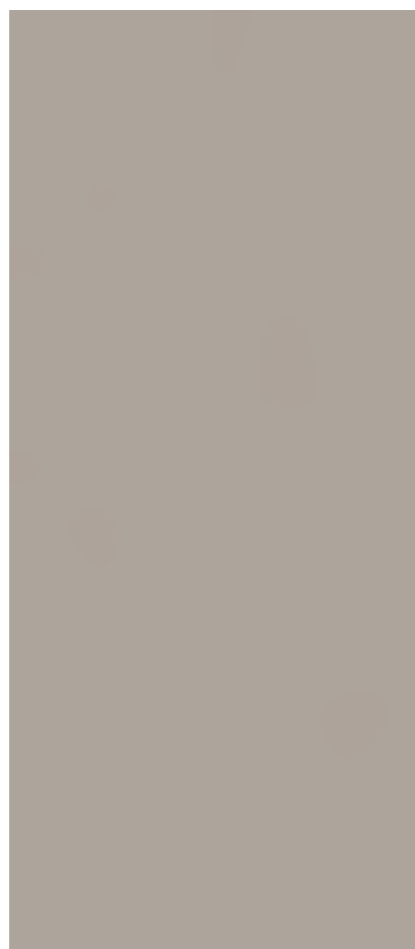

TAUPE

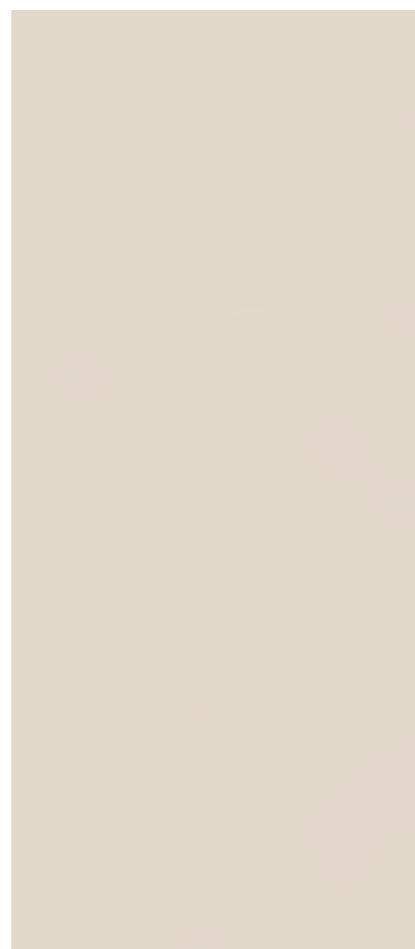

BEIGE

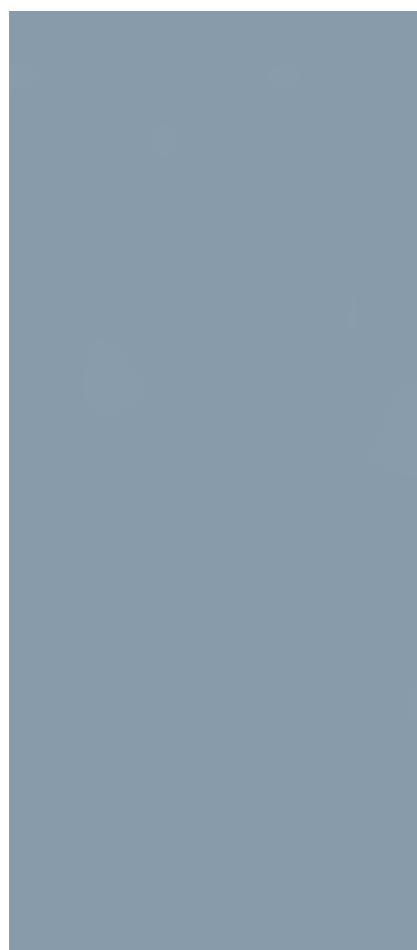

AVIO



SAGE

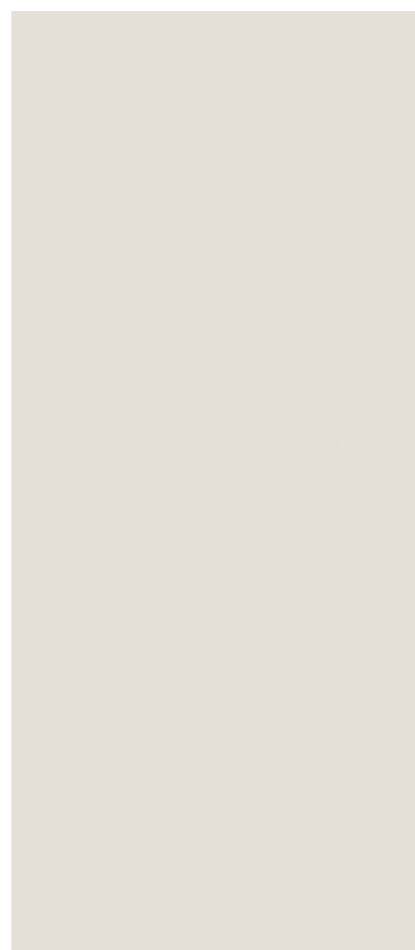

IVORY



Floor
Beige 60x120_24"x48" Nat Ret

Wall
Sage 60x120_24"x48" Nat Ret

Le Malte

6 mm

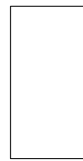

120x280
48"x110"

Nat Ret



120x120
48"x48"

Nat Ret



60x120
24"x48"

Nat Ret

| | 120x280 48"x110" | 120x120 48"x48" | 60x120 24"x48" |
|------------|---------------------|--------------------|-------------------|
| | Nat Ret | Nat Ret | Nat Ret |
| GREY | 198003 | 198013 | 198023 |
| TAUPE | 198005 | 198015 | 198025 |
| BEIGE | 198004 | 198014 | 198024 |
| IVORY | 198002 | 198012 | 198022 |
| SAGE | 198006 | 198016 | 198026 |
| AVIO | 198001 | 198011 | 198021 |
| Price code | M153 | M141 | M118 |

La struttura e il tono tra i fondi di spessore 6mm e 8,8mm potrebbero presentare differenze.

The structure and shade of the tiles with 6 mm and 8.8 mm thickness could show differences.

La structure et la teinte des carreaux de 6 mm et 8,8 mm d'épaisseur peuvent présenter des différences.

Die Struktur und der Farbton der Fliesen mit einer Dicke von 6 mm und 8,8 mm könnten Unterschiede aufweisen.

Pezzi Speciali / Trims. Pièces speciale. Die Sonderstücke

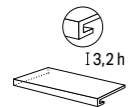

13,2 h

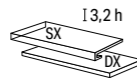

13,2 h

6 mm

Gradino costa retta**
Straight nosed stair**

Gradino costa retta SX - DX**
Straight-edge step L-R

| | 33x120 Nat Ret | 33x120 Nat Ret |
|------------|-------------------|------------------------|
| GREY | 198063 | 198083 SX 198093 DX |
| TAUPE | 198065 | 198085 SX 198095 DX |
| BEIGE | 198064 | 198084 SX 198094 DX |
| IVORY | 198062 | 198082 SX 198092 DX |
| SAGE | 198066 | 198086 SX 198096 DX |
| AVIO | 198061 | 198081 SX 198091 DX |
| Price code | P243 | P273 |



Battiscopa
Skirting

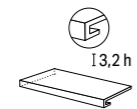

13,2 h

Gradino costa retta**
Straight nosed stair**

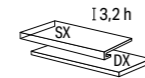

13,2 h

Gradino costa retta SX - DX**
Straight-edge step L-R

8,8 mm

| | 8x80 Nat Ret | 33x80 Nat Ret | 33x80 Nat Ret |
|------------|-----------------|------------------|------------------------|
| GREY | 198053 | 198073 | 198103 SX 198113 DX |
| TAUPE | 198055 | 198075 | 198105 SX 198115 DX |
| BEIGE | 198054 | 198074 | 198104 SX 198114 DX |
| IVORY | 198052 | 198072 | 198102 SX 198112 DX |
| Price code | P029 | P167 | P179 |

8,8 mm



80x80
31 1/2"x31 1/2"

Nat Ret

| | 80x80 31 1/2"x31 1/2" |
|------------|--------------------------|
| | Nat Ret |
| GREY | 198033 |
| TAUPE | 198035 |
| BEIGE | 198034 |
| IVORY | 198032 |
| Price code | M097 |



Wall
Taupe 120x280_48"x110" Nat Ret
Bolgheri Stone Sage 120x280_48"x110" Lap Ret

Floor
Taupe 120x280_48"x110" Nat Ret

Calpestio . Foot traffic

• SAGE, AVIO LOW • GREY, TAUPE MEDIUM • IVORY, BEIGE HIGH

Imballi / Packings. Emballage. Verpackung

| | PCS/BOX | MQ/BOX | KG/BOX | PCS/PAL | BOX/PAL | MQ/PAL | KG/PAL | PACKING | PACKING SIZE | TARE (KG) |
|---------------|---------|--------|--------|---------|---------|--------|--------|------------------|-----------------|-----------|
| 6 mm | | | | | | | | | | |
| 120 x 280 | - | - | - | 20 | - | 67,20 | 974 | CASSA | 292 x 145 x 35h | 108 |
| 120 x 120 | - | - | - | 44 | - | 147,84 | 2.140 | CAVALLETTO LEGNO | 290 x 75 x 161h | 145 |
| 60 x 120 | 2 | 2,88 | 41,76 | 48 | 24 | 69,12 | 1.002 | PALLET SPECIALE | 123x143x74h | 29 |
| 80 x 80 | 2 | 1,44 | 21 | - | 40 | 57,60 | 840 | EPAL | 80 x 120 x 75h | 22 |
| 8,8 mm | | | | | | | | | | |
| 80 x 80 | 2 | 1,28 | 23,2 | - | 50 | 64 | 1.161 | EPAL | 80 x 120 x 95h | 22 |



Cavalletto in legno
Wood A-Frame. Support en bois.
Holzgestell



Cassa
Crate . Caisse . Kiste



Pallet speciale con sponde
Special pallet with sides .
Palette spéciale avec bords.
Spezial-Palette mit Wandungen.



Epal

| PEZZI SPECIALI. TRIMS | PCS/BOX | MQ/BOX | KG/BOX | PACKING | PACKING SIZE | TARE (KG) |
|--|---------|--------|--------|---------|--------------|-----------|
| 6 mm | | | | | | |
| GRADINO COSTA RETTA 33 x 120 x 3,2h ** | 2 | - | 14 | EPAL | 80 x 120 | 22 |
| GRADINO COSTA RETTA 33 x 120 x 3,2h SX/DX ** | 1 | - | 7 | EPAL | 80 x 120 | 22 |
| 8,8 mm | | | | | | |
| BATTISCOPA 8 x 80 | 11 | - | 14,8 | EPAL | 80 x 120 | 22 |
| GRADINO COSTA RETTA 33 x 80 x 3,2h ** | 2 | - | 16 | EPAL | 80 x 120 | 22 |
| GRADINO COSTA RETTA 33 x 80 x 3,2h SX/DX ** | 1 | - | 8,50 | EPAL | 80 x 120 | 22 |

** A disposizione solo su richiesta. Tempi di consegna: 30gg
Available upon request only. Delivery terms: 30 days
Disponible seulement sur requête. Délais de livraison: 30 jours
Verfügbar auf Anfrage. Lieferzeit: 30 Tage



Space
MATERICO

PLOMB

CEMENT

BONE



Gres Porcellanato. Porcelain tiles
Grès cérame. Feinsteinzeug
ISO 13006 - G - Bla_E ≤ 0,5%
UNIEN 14411

ANSI A - 326.3: 2021
W E T D Y N A M I C
COEFFICIENT OF FRICTION

DCOF ≥ 0,42

8,8 mm R10B



80x80
31½"x31½"
Nat Ret R10B



60x120
24"x48"
Nat Ret R10B



60x60
24"x24"
Nat Ret R10B



30x60
12"x24"
Nat Ret R10B



20x20
8"x8"
Nat R10B

modular system

Decori / Decors



Diamond 20x20
8"x8"
Nat R10B



Map 20x20
8"x8"
Nat R10B



Dot 20x20
8"x8"
Nat R10B



Imperial 20x20
8"x8"
Nat R10B



Flower 20x20
8"x8"
Nat R10B



Leaf 20x20
8"x8"
Nat R10B



Spot 20x20
8"x8"
Nat R10B



Cubic 20x20
8"x8"
Nat R10B



Mosaico 30x30
12"x12"
Nat Ret R10B

8,8 mm



80x80
31½"x31½"
Nat Ret R11C

20 mm OUTDOOR



80x80
31½"x31½"
Nat Ret R11C

Space

MATERICO

100% DESIGN AND PRODUCTION OF ITALY

Sviluppo grafico per formato
Pattern by size
Développement graphique par format
Grafischer Entwurf für Format

60x120
8,8 mm
24

80x80
8,8 mm
25

60x60
8,8 mm
46

30x60
8,8 mm
92

20x20
8,8 mm
10

80x80
20 mm
25

Sviluppo Grafico

Pattern by size. Développement graphique par format. Grafischer Entwurf für Format

CEMENT 60x120 8,8 mm

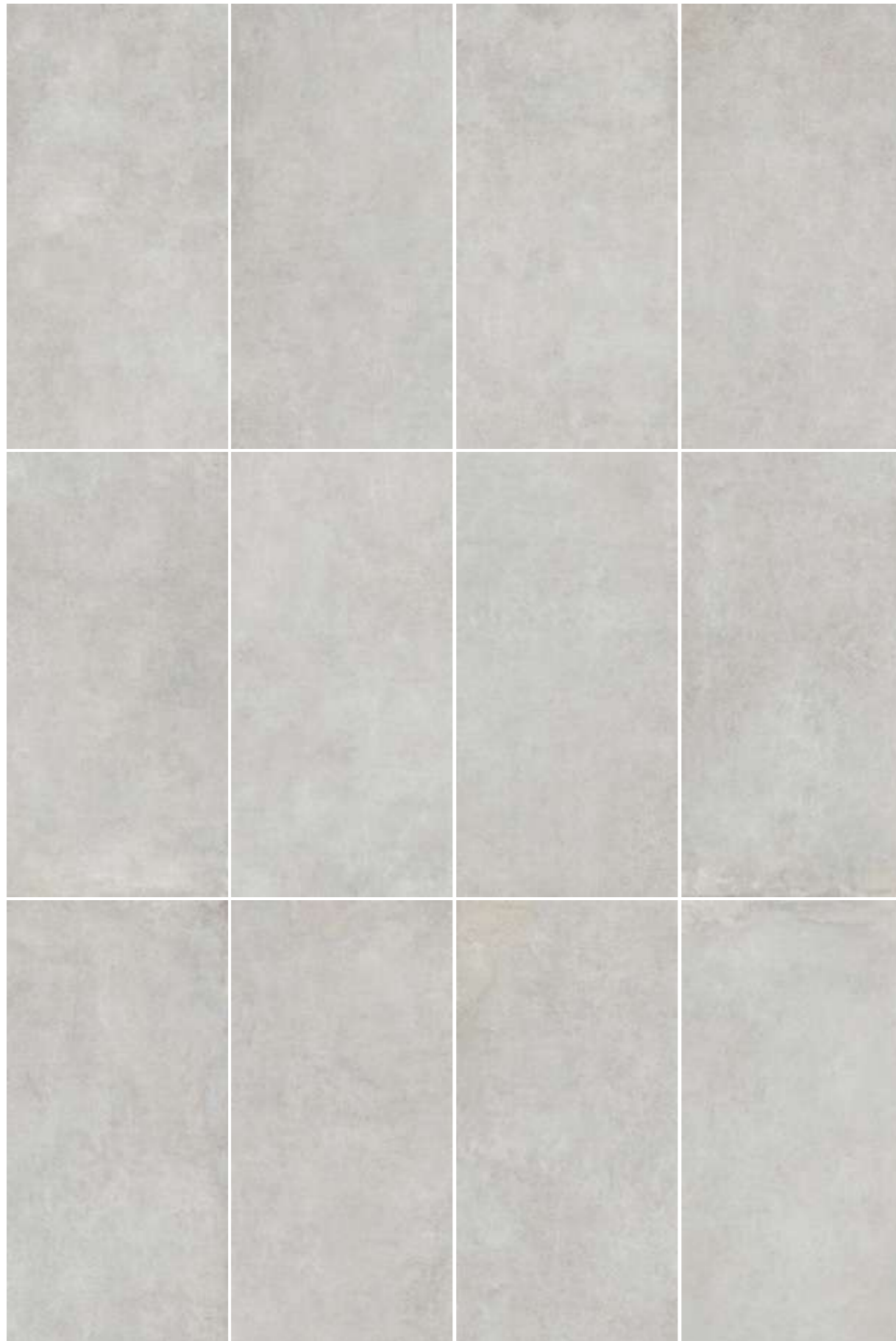

Lo sviluppo grafico mostra solo una selezione dei pattern disponibili. Il numero totale delle grafiche è indicato di seguito.
 The graphic development shows only a selection of the available patterns. The total number of patterns is specified below.
 Le développement graphique montre uniquement une sélection des motifs disponibles. Le nombre total de motifs est indiqué ci-dessous.
 Die grafische Entwicklung zeigt nur eine Auswahl der verfügbaren Muster. Die Gesamtzahl der Muster ist unten angegeben.

PATTERNS 24

Decorì

Decors

8,8 mm R10B

PLOMB

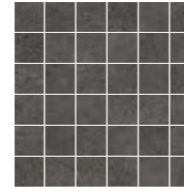

Mosaico 30x30
12"x12"
Nat Ret **R10B**

CEMENT



Mosaico 30x30
12"x12"
Nat Ret **R10B**

BONE

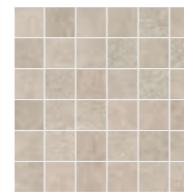

Mosaico 30x30
12"x12"
Nat Ret **R10B**



**** Pattern 20x20_8"x8"**
Nat **R10B**



*** Diamond**
20x20_8"x8"
Nat **R10B**



*** Map**
20x20_8"x8"
Nat **R10B**



*** Dot**
20x20_8"x8"
Nat **R10B**



*** Imperial**
20x20_8"x8"
Nat **R10B**



**** Pattern 20x20_8"x8"**
Nat **R10B**



*** Flower**
20x20_8"x8"
Nat **R10B**



*** Leaf**
20x20_8"x8"
Nat **R10B**



*** Spot**
20x20_8"x8"
Nat **R10B**



*** Imperial**
20x20_8"x8"
Nat **R10B**



**** Pattern 20x20_8"x8"**
Nat **R10B**



*** Flower**
20x20_8"x8"
Nat **R10B**



*** Leaf**
20x20_8"x8"
Nat **R10B**

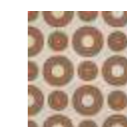

*** Dot**
20x20_8"x8"
Nat **R10B**



*** Cubic**
20x20_8"x8"
Nat **R10B**

*** Questo formato non è modulare ed abbinabile agli altri formati in gamma**

This size is not modular and cannot be used together with the other sizes in the range.
 Ce format n'est pas modulaire et il ne peut être associé aux autres formats de la gamme.
 Dieses Format ist nicht modular und lässt sich mit anderen Formaten der Serie kombinieren.

**** In ogni scatola la combinazione dei soggetti è del tutto casuale. Lo stesso soggetto potrebbe essere ripetuto oppure potrebbe non essere presente nella scatola.**

Each box contains a random assortment of the designs available. The same design may be repeated and certain designs may not be included in the box.

La combinaison des motifs à l'intérieur de chaque boîte est absolument fortuite. Le même motif pourrait être répété ou ne pas se trouver à l'intérieur de la boîte.

Die Zusammenstellung der Motive ist in jedem Karton vollkommen zufällig. Dasselbe Motiv kann mehrfach vorkommen oder im Karton fehlen.

Space

8,8 mm

| | 80x80 31 1/2"x31 1/2" | 60x120 24"x48" | 60x60 24"x24" | 30x60 12"x24" | 20x20* 8"x8" |
|------------|--------------------------|---------------------|---------------------|---------------------|-----------------|
| | Nat Ret R10B | Nat Ret R10B | Nat Ret R10B | Nat Ret R10B | Nat R10B |
| PLOMB | 106008 | 106023 | 106028 | 106033 | 106073 |
| CEMENT | 106007 | 106022 | 106027 | 106032 | 106072 |
| BONE | 106006 | 106021 | 106026 | 106031 | 106071 |
| Price code | M097 | M097 | M083 | M081 | M075 |

8,8 mm

| | 80x80 31 1/2"x31 1/2" | 80x80 31 1/2"x31 1/2" |
|------------|--------------------------|--------------------------|
| | Nat Ret R11C | Nat Ret R11C |
| PLOMB | 106013 | 106018 |
| CEMENT | 106012 | 106017 |
| BONE | 106011 | 106016 |
| Price code | M097 | M137 |

8,8 mm

| | Mosaico 30x30 12"x12" | Flower* 20x20 8"x8" | Leaf* 20x20 8"x8" | Dot* 20x20 8"x8" | Cubic* 20x20 8"x8" | Imperial* 20x20 8"x8" | Spot* 20x20 8"x8" | Diamond* 20x20 8"x8" | Map* 20x20 8"x8" | Pattern** 20x20 8"x8" |
|------------|-----------------------------|---------------------------|-------------------------|------------------------|--------------------------|-----------------------------|-------------------------|----------------------------|------------------------|-----------------------------|
| | Nat Ret R10B | Nat R10B | Nat R10B | Nat R10B | Nat R10B | Nat R10B | Nat R10B | Nat R10B | Nat R10B | Nat R10B |
| PLOMB | 106053 | - | - | 106087 | - | 106085 | - | 106086 | 106088 | 106076 |
| CEMENT | 106052 | 106083 | 106081 | - | - | 106082 | 106084 | - | - | 106075 |
| BONE | 106051 | 106077 | 106078 | 106079 | 106080 | - | - | - | - | 106074 |
| Price code | M135 | M081 | M081 | M081 | M081 | M081 | M081 | M081 | M081 | M081 |

Pezzi Speciali / Trims. Pièces speciale. Die Sonderstücke

8,8 mm

| | 6,5x120 | 7x60 | 33x120 | 33x80 | 33x60 | 33x120 | 33x80 | 33x60 |
|------------|---------------------|---------------------|---------------------|---------------------|---------------------|------------------------|------------------------|------------------------|
| | Nat Ret R10B | Nat Ret R10B | Nat Ret R10B | Nat Ret R10B | Nat Ret R10B | Nat Ret R10B | Nat Ret R10B | Nat Ret R10B |
| PLOMB | 106063 | 106068 | 106107 | 106127 | 106206 | 106109 SX 106108 DX | 106129 SX 106128 DX | 106208 SX 106207 DX |
| CEMENT | 106062 | 106067 | 106104 | 106124 | 106203 | 106106 SX 106105 DX | 106126 SX 106125 DX | 106205 SX 106204 DX |
| BONE | 106061 | 106066 | 106101 | 106121 | 106200 | 106103 SX 106102 DX | 106123 SX 106122 DX | 106202 SX 106201 DX |
| Price code | P040 | P021 | P207 | P167 | P135 | P219 | P179 | P151 |

20 mm

| | 40x80 | | 40x80 | | 20x80 | 20x80 |
|------------|-----------------------------------|------------------------------------|-----------------------------------|------------------------------------|-------------|------------------------|
| | Costa tolo Nat Ret R11C | Costa retta Nat Ret R11C | Costa tolo Nat Ret R11C | Costa retta Nat Ret R11C | R11C | R11C |
| PLOMB | 106389 | 106380 | 106395 SX 106392 DX | 106386 SX 106383 DX | 106398 | 106404 SX 106401 DX |
| CEMENT | 106388 | 106379 | 106394 SX 106391 DX | 106385 SX 106382 DX | 106397 | 106403 SX 106400 DX |
| BONE | 106387 | 106378 | 106393 SX 106390 DX | 106384 SX 106381 DX | 106396 | 106402 SX 106399 DX |
| Price code | P181 | P175 | P203 | P197 | P239 | P239 |

Calpestio . Foot traffic

• PLOMB LOW • CEMENT, BONE HIGH

Imballi / Packings. Emballage. Verpackung

| | PCS/BOX | MQ/BOX | KG/BOX | BOX/PAL | MQ/PAL | KG/PAL | PACKING | PACKING SIZE |
|---------------|---------|--------|--------|---------|--------|--------|---------|----------------|
| 8,8 mm | | | | | | | | |
| 80 x 80 | 2 | 1,28 | 23,6 | 50 | 64 | 1.182 | EPAL | 80 x 120 x 95h |
| 80 x 80 R11 C | 2 | 1,28 | 23,6 | 50 | 64 | 1.182 | EPAL | 80 x 120 x 95h |
| 60 x 120 | 2 | 1,44 | 27,9 | 32 | 46,08 | 893 | EPAL | 80 x 120 x 75h |
| 60 x 60 | 3 | 1,08 | 20,3 | 40 | 43,20 | 811 | EPAL | 80 x 120 x 75h |
| 30 x 60 | 7 | 1,26 | 24 | 48 | 60,48 | 1.152 | EPAL | 80 x 120 x 75h |
| 20 x 20 * | 30 | 1,20 | 23 | 60 | 72,00 | 1.382 | PALLET | 80 x 120 x 75h |
| 20 mm | | | | | | | | |
| 80 x 80 | 1 | 0,64 | 28,4 | 40 | 25,60 | 1.137 | EPAL | 80 x 120 x 95h |

PEZZI SPECIALI. TRIMS

| | PCS/BOX | MQ/BOX | KG/BOX | BOX/PAL | MQ/PAL | KG/PAL | PACKING | PACKING SIZE |
|--|---------|--------|--------|---------|--------|--------|---------|----------------|
| 8,8 mm | | | | | | | | |
| BATTISCOPA 6,5 x 120 | 6 | 0,47 | 10,55 | 45 | 21,15 | 495 | EPAL | 80 x 120 x 55h |
| BATTISCOPA 7 x 60 | 15 | 0,63 | 14,76 | 56 | 35,28 | 846 | EPAL | 80 x 120 x 50h |
| GRADINO COSTA RETTA 33 x 120 *** | 2 | - | 23,00 | - | - | - | EPAL | 80 x 120 |
| GRADINO COSTA RETTA 33 x 120 SX/DX *** | 1 | - | 12,00 | - | - | - | EPAL | 80 x 120 |
| GRADINO COSTA RETTA 33 x 80 *** | 2 | - | 16,00 | - | - | - | EPAL | 80 x 120 |
| GRADINO COSTA RETTA 33 x 80 SX /DX *** | 1 | - | 8,50 | - | - | - | EPAL | 80 x 120 |
| GRADINO COSTA RETTA 33 x 60 *** | 4 | - | 23,00 | - | - | - | EPAL | 80 x 120 |
| GRADINO COSTA RETTA 33 x 60 SX/DX *** | 2 | - | 12,00 | - | - | - | EPAL | 80 x 120 |

PEZZI SPECIALI. TRIMS

| | PCS/BOX | MQ/BOX | KG/BOX | PACKING | PACKING SIZE |
|---------------------------|---------|--------|--------|---------|--------------|
| 20 mm | | | | | |
| GRADONE 40 x 80 *** | 1 | - | 12,50 | EPAL | 80 x 120 |
| GRADONE 40 x 80 SX/DX *** | 1 | - | 12,50 | EPAL | 80 x 120 |
| GRIGLIA 20 x 80 *** | 1 | - | 8,00 | EPAL | 80 x 120 |
| GRIGLIA 20 x 80 SX/DX *** | 1 | - | 7,50 | EPAL | 80 x 120 |

La gamma completa dei pezzi speciali è disponibile nella "PARTE TECNICA" del catalogo a pag. 537
Our entire range of trims is available in our "TECHNICAL SECTION" of this catalogue pag. 537.
La gamme complète des pièces spéciaux est disponible dans la section "PARTIE TECHNIQUE" à la pag. 537 de ce catalogue.
Das komplette Sortiment an Sonderstücken ist in dem "technischen Teil" des Katalogs auf Seite 537 verfügbar.



Artile
MATERICO

BLACK GOLD

SAGE

OCEAN BLUE

IVORY

GREIGE

COPPER



Gres Porcellanato. Porcelain tiles
Grès cérame. Feinsteinzeug
ISO 13006 - G - Bla_E ≤ 0,5%
UNIEN 14411

ANSI A - 326.3: 2021
W E T - D Y N A M I C
COEFFICIENT OF FRICTION

DCOF ≥ 0,42

8,8 mm



60x120
24"x48"
Nat Ret **R10A**



20x120
8"x48"
Nat Ret **R10A**



60x60
24"x24"
Nat Ret **R10A**



30x60
12"x24"
Nat Ret **R10A**

modular system

Decor / Decors



Mosaico 30x30
12"x12"
Nat Ret **R10A**



Muretto 30x30
12"x12"
Nat Ret **R10A**



Esagona 28x29
11"x11 1/2"
Nat Ret **R10A**



Spina di pesce 27x25,5
10 1/2"x10"
Nat Ret **R10A**

Artile

MATERICO

100% DESIGN AND PRODUCTION OF ITALY

Sviluppo grafico per formato
Pattern by size
Développement graphique par format
Grafischer Entwurf für Format

60x120
8,8 mm
18

20x120
8,8 mm
12

60x60
8,8 mm
36

30x60
8,8 mm
18

Sviluppo Grafico

Pattern by size. Développement graphique par format. Grafischer Entwurf für Format

IVORY 60x120 8,8 mm



Lo sviluppo grafico mostra solo una selezione dei pattern disponibili. Il numero totale delle grafiche è indicato di seguito.
 The graphic development shows only a selection of the available patterns. The total number of patterns is specified below.
 Le développement graphique montre uniquement une sélection des motifs disponibles. Le nombre total de motifs est indiqué ci-dessous.
 Die grafische Entwicklung zeigt nur eine Auswahl der verfügbaren Muster. Die Gesamtzahl der Muster ist unten angegeben.

PATTERNS 18

Decorì

Decors

8,8 mm

BLACK GOLD

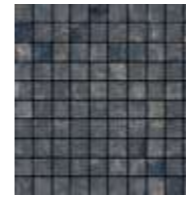

SAGE



OCEAN BLUE



IVORY



GREIGE



COPPER

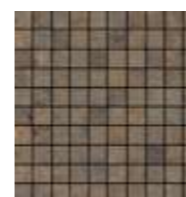

Mosaico 30x30
 12"x12"
 Nat Ret **[R10A]**





Muretto 30x30
 12"x12"
 Nat Ret **[R10A]**

Esagona 28x29
 11"x11 1/2"
 Nat Ret **[R10A]**





Spina di pesce 27x25,5
 10 1/2"x10"
 Nat Ret **[R10A]**

Artile

8,8 mm

| |  |  |  |  |
|------------|---|---|---|---|
| | 60x120 24"x48" | 20x120 8"x48" | 60x60 24"x24" | 30x60 12"x24" |
| | Nat Ret R10A | Nat Ret R10A | Nat Ret R10A | Nat Ret R10A |
| BLACK GOLD | 156006 | 156031 | 156011 | 156021 |
| SAGE | 156005 | 156035 | 156015 | 156025 |
| OCEAN BLUE | 156004 | 156036 | 156016 | 156026 |
| IVORY | 156001 | 156033 | 156013 | 156023 |
| GREIGE | 156002 | 156032 | 156012 | 156022 |
| COPPER | 156003 | 156034 | 156014 | 156024 |
| Price code | M109 | M109 | M093 | M085 |

8,8 mm

| |  |  |  |  |
|------------|---|---|---|---|
| | Mosaico 30x30 12"x12" | Muretto 30x30 12"x12" | Esagona 28x29 11"x11 1/2" | Spina di pesce 27x25,5 10 1/2"x10" |
| | Nat Ret R10A | Nat Ret R10A | Nat Ret R10A | Nat Ret R10A |
| BLACK GOLD | 156321 | 156311 | 156331 | 156301 |
| SAGE | 156325 | 156315 | 156335 | 156305 |
| OCEAN BLUE | 156326 | 156316 | 156336 | 156306 |
| IVORY | 156323 | 156313 | 156333 | 156303 |
| GREIGE | 156322 | 156312 | 156332 | 156302 |
| COPPER | 156324 | 156314 | 156334 | 156304 |
| Price code | M193 | M199 | M303 | M177 |

Pezzi Speciali / Trims. Pièces speciale. Die Sonderstücke

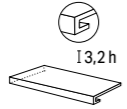
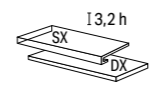
| |  |  |  |
|------------|---|---|---|
| | Battiscopa Skirting | Gradino costa retta** Straight nosed stair** | Gradino costa retta SX - DX** Straight-edge step L-R |
| | 7x60 | 33x120 | 33x120 |
| | Nat Ret R10A | Nat Ret R10A | Nat Ret R10A |
| BLACK GOLD | 156101 | 156201 | 156221 SX 156211 DX |
| SAGE | 156105 | 156205 | 156225 SX 156215 DX |
| OCEAN BLUE | 156106 | 156206 | 156226 SX 156216 DX |
| IVORY | 156103 | 156203 | 156223 SX 156213 DX |
| GREIGE | 156102 | 156202 | 156222 SX 156212 DX |
| COPPER | 156104 | 156204 | 156224 SX 156214 DX |
| Price code | P021 | P207 | P231 |



Wall
Ivory 60x120_24"x48" Nat Ret
Floor
Greige 60x120_24"x48" Nat Ret

Calpestio . Foot traffic

• BLACK GOLD, SAGE, OCEAN BLUE, COPPER  LOW • GREIGE  MEDIUM • IVORY  HIGH

Imballi / Packings. Emballage. Verpackung

| | PCS/BOX | MQ/BOX | KG/BOX | BOX/PAL | MQ/PAL | KG/PAL | PACKING | PACKING SIZE |
|--------------------------|---------|--------|--------|---------|--------|--------|---|----------------|
| 8,8 mm | | | | | | |  | |
| 60 x 120 | 2 | 1,44 | 26,7 | 32 | 46,08 | 855 | EPAL | 80 x 120 x 75h |
| 20 x 120 | 4 | 0,96 | 18,2 | 60 | 57,60 | 1.094 | EPAL | 80 x 120 x 70h |
| 60 x 60 | 3 | 1,08 | 20,3 | 40 | 43,20 | 814 | EPAL | 80 x 120 x 75h |
| 30 x 60 | 7 | 1,26 | 24,1 | 48 | 60,48 | 1.157 | EPAL | 80 x 120 x 75h |
| DECORI. DECORS | | | | | | | | |
| MOSAICO 30 x 30 | 6 | 0,54 | 10,4 | 60 | 32,40 | 622 | EPAL | 80 x 120 |
| MURETTO 30 x 30 | 6 | 0,54 | 10,4 | 60 | 32,40 | 622 | EPAL | 80 x 120 |
| ESAGONA 28 x 29 | 6 | 0,49 | 9,4 | 60 | 29,23 | 565 | EPAL | 80 x 120 |
| SPINA DI PESCE 27 x 25,5 | 6 | 0,42 | 8,1 | 60 | 25,20 | 484 | EPAL | 80 x 120 |

| PEZZI SPECIALI. TRIMS | PCS/BOX | MQ/BOX | KG/BOX | PACKING | PACKING SIZE |
|--|---------|--------|--------|---------|--------------|
| 8,8 mm | | | | | |
| BATTISCOPA 7 x 60 | 15 | 0,63 | 13 | EPAL | 80 x 120 |
| GRADINO COSTA RETTA 33 x 120 x 3,2h ** | 2 | - | 23 | EPAL | 80 x 120 |
| GRADINO COSTA RETTA 33 x 120 x 3,2h SX/DX ** | 1 | - | 12 | EPAL | 80 x 120 |

** A disposizione solo su richiesta. Tempi di consegna: 30gg
Available upon request only. Delivery terms: 30 days
Disponible seulement sur requête. Délais de livraison: 30 jours
Verfügbar auf Anfrage. Lieferzeit: 30 Tage

Lascaux

MATERICO



KIMBERLY

NAXA

JEITA

CAPRI

ELLISON



Gres Porcellanato. Porcelain tiles
Grès cérame. Feinsteinzeug
ISO 13006 - G - Bla_E ≤ 0,5%
UNI EN 14411

ANSI A - 326.3: 2021
W E T - D Y N A M I C
COEFFICIENT OF FRICTION

DCOF ≥ 0,42 | naturale

8,8 mm



60x120
24"x48"
Nat Ret **R10A**
Lap Ret



30x120
12"x48"
Nat Ret **R10A**
Lap Ret



20x120
8"x48"
Nat Ret **R10A**
Lap Ret



60x60
24"x24"
Nat Ret **R10A**
Lap Ret



30x60
12"x24"
Nat Ret **R10A**
Lap Ret

modular system

Decoro / Decor



Mosaico 30x30
12"x12"
Nat Ret **R10A**
Lap Ret

Lascaux

MATERICO

100% DESIGN AND PRODUCTION OF ITALY

Sviluppo grafico per formato
Pattern by size
Développement graphique par format
Grafischer Entwurf für Format

60x120
8,8 mm

23

30x120
8,8 mm

38

20x120
8,8 mm

68

60x60
8,8 mm

29

30x60
8,8 mm

33

Sviluppo Grafico

Pattern by size. Développement graphique par format. Grafischer Entwurf für Format

KIMBERLY 60x120 8,8 mm



Lo sviluppo grafico mostra solo una selezione dei pattern disponibili. Il numero totale delle grafiche è indicato di seguito.

The graphic development shows only a selection of the available patterns. The total number of patterns is specified below.

Le développement graphique montre uniquement une sélection des motifs disponibles. Le nombre total de motifs est indiqué ci-contre.

Die grafische Entwicklung zeigt nur eine Auswahl der verfügbaren Muster. Die Gesamtzahl der Muster ist unten angegeben.

PATTERNS 23

Lascaux

8,8 mm

| | 60x120 24"x48" | | 30x120 12"x48" | | 20x120 8"x48" | | 60x60 24"x24" | | 30x60 12"x24" | | Mosaico 30x30 12"x12" | |
|------------|-------------------|---------|-------------------|---------|------------------|---------|------------------|---------|------------------|---------|--------------------------|---------|
| | Nat Ret [R10A] | Lap Ret | Nat Ret [R10A] | Lap Ret | Nat Ret [R10A] | Lap Ret | Nat Ret [R10A] | Lap Ret | Nat Ret [R10A] | Lap Ret | Nat Ret [R10A] | Lap Ret |
| KIMBERLY | 089013 | 089014 | 089033 | 089034 | 089053 | 089054 | 089093 | 089094 | 089113 | 089114 | 089173 | 089174 |
| NAXA | 089017 | 089018 | 089037 | 089038 | 089057 | 089058 | 089097 | 089098 | 089117 | 089118 | 089177 | 089178 |
| JEITA | 089009 | 089010 | 089029 | 089030 | 089049 | 089050 | 089089 | 089090 | 089109 | 089110 | 089169 | 089170 |
| CAPRI | 089001 | 089002 | 089021 | 089022 | 089041 | 089042 | 089081 | 089082 | 089101 | 089102 | 089161 | 089162 |
| ELLISON | 089005 | 089006 | 089025 | 089026 | 089045 | 089046 | 089085 | 089086 | 089105 | 089106 | 089165 | 089166 |
| Price code | M109 | M125 | M113 | M129 | M113 | M129 | M089 | M113 | M089 | M113 | M159 | M187 |

Pezzi Speciali / Trims. Pièces speciale. Die Sonderstücke

| | 6,5x120 | | 33x120 | | 33x60 | | 33x120 | | 33x60 | |
|------------|----------------|---------|----------------|---------|----------------|---------|------------------------|------------------------|------------------------|------------------------|
| | Nat Ret [R10A] | Lap Ret | Nat Ret [R10A] | Lap Ret | Nat Ret [R10A] | Lap Ret | Nat Ret [R10A] | Lap Ret | Nat Ret [R10A] | Lap Ret |
| KIMBERLY | 089188 | 089189 | 089272 | 089273 | 089212 | 089213 | 089312 SX 089292 DX | 089313 SX 089293 DX | 089252 SX 089232 DX | 089253 SX 089233 DX |
| NAXA | 089190 | 089191 | 089276 | 089277 | 089216 | 089217 | 089316 SX 089296 DX | 089317 SX 089297 DX | 089256 SX 089236 DX | 089257 SX 089237 DX |
| JEITA | 089186 | 089187 | 089268 | 089269 | 089208 | 089209 | 089308 SX 089288 DX | 089309 SX 089289 DX | 089248 SX 089228 DX | 089249 SX 089229 DX |
| CAPRI | 089181 | 089182 | 089260 | 089261 | 089200 | 089201 | 089300 SX 089280 DX | 089301 SX 089281 DX | 089240 SX 089220 DX | 089241 SX 089221 DX |
| ELLISON | 089183 | 089184 | 089264 | 089265 | 089204 | 089205 | 089304 SX 089284 DX | 089305 SX 089285 DX | 089244 SX 089224 DX | 089245 SX 089225 DX |
| Price code | P040 | P043 | P207 | P215 | P141 | P143 | P231 | P243 | P169 | P173 |

Calpestio . Foot traffic

• NAXA LOW • KIMBERLY, JEITA, ELLISON MEDIUM • CAPRI HIGH

Imballi / Packings. Emballage. Verpackung

| | PCS/BOX | MQ/BOX | KG/BOX | BOX/PAL | MQ/PAL | KG/PAL | PACKING | PACKING SIZE |
|------------------------|---------|--------|--------|---------|--------|--------|---------|----------------|
| 8,8 mm | | | | | | | | |
| 60 x 120 Nat | 2 | 1,44 | 27,90 | 32 | 46,08 | 872 | EPAL | 80 x 120 x 75h |
| 60 x 120 Lap | 2 | 1,44 | 27,90 | 30 | 43,20 | 837 | EPAL | 80 x 120 x 75h |
| 30 x 120 | 3 | 1,08 | 21 | 45 | 48,60 | 945 | EPAL | 80 x 120 x 75h |
| 20 x 120 Lap | 6 | 1,44 | 27,90 | 24 | 34,56 | 668 | EPAL | 80 x 120 x 75h |
| 20 x 120 Nat | 4 | 0,96 | 17,7 | 60 | 57,60 | 1.061 | EPAL | 80 x 120 x 75h |
| 60 x 60 | 3 | 1,08 | 21 | 40 | 43,20 | 840 | EPAL | 80 x 120 x 75h |
| 30 x 60 Nat | 7 | 1,26 | 24 | 48 | 60,48 | 1.152 | EPAL | 80 x 120 x 75h |
| 30 x 60 Lap | 6 | 1,08 | 21 | 40 | 43,20 | 840 | EPAL | 80 x 120 x 75h |
| DECORI. DECORS | | | | | | | | |
| MOSAICO 30 x 30 | 6 | 0,54 | 13,23 | 54 | 29,16 | 714,42 | EPAL | 80 x 120 x 73h |



| | PCS/BOX | MQ/BOX | KG/BOX | PACKING | PACKING SIZE |
|---|---------|--------|--------|---------|--------------|
| 8,8 mm | | | | | |
| BATTISCOPIA 6,5 x 120 | 6 | 0,47 | 10,55 | EPAL | 80 x 120 |
| GRADINO COSTA RETTA 33 x 120 x 3,2h ** | 2 | - | 23,00 | EPAL | 80 x 120 |
| GRADINO COSTA RETTA 33 x 120 x 3,2h Sx/Dx** | 1 | - | 13,00 | EPAL | 80 x 120 |
| GRADINO COSTA RETTA 33 x 60 x 3,2h ** | 4 | - | 20,00 | EPAL | 80 x 120 |
| GRADINO COSTA RETTA 33 x 60 x 3,2h Sx/Dx** | 2 | - | 11,00 | EPAL | 80 x 120 |

** A disposizione solo su richiesta. Tempi di consegna: 30gg
Available upon request only. Delivery terms: 30 days
Disponible seulement sur requête. Délais de livraison: 30 jours
Verfügbar auf Anfrage. Lieferzeit: 30 Tage



Cotto del Casale MATERICO

Cotto del Casale
MATERICO

BRUNO

ROSADO

OCRA

GREIGE



Gres Porcellanato. Porcelain tiles
Grès cérame. Feinsteinzeug
ISO 13006 - G - Bla_E ≤ 0,5%
UNIEN 14411

ANSI A - 326.3: 2021
W E T - D Y N A M I C
COEFFICIENT OF FRICTION

DCOF ≥ 0,42

8,8 mm



60,9x60,9
24"x24"
Nat



40,6x60,9
16"x24"
Nat



40,6x40,6
16"x16"
Nat



20,3x40,6
8"x16"
Nat



20,3x20,3
8"x8"
Nat

modular system

Decor / Decors



Capri 20,3x20,3
8"x8"
Lucido



Pompei 20,3x20,3
8"x8"
Satinato



Pompei Fascia 10x40,6
4"x16"
Satinato

8,8 mm



60,9x60,9
24"x24"
Nat R11C



40,6x60,9
16"x24"
Nat R11C



40,6x40,6
16"x16"
Nat R11C



20,3x40,6
8"x16"
Nat R11C



20,3x20,3
8"x8"
Nat R11C

modular system

Rosado, Bruno

Cotto del Casale

MATERICO

100% DESIGN AND PRODUCTION OF ITALY

Sviluppo grafico per formato
Pattern by size
Développement graphique par format
Grafischer Entwurf für Format

60,9x60,9
8,8 mm

16

40,6x60,9
8,8 mm

27

40,6x40,6
8,8 mm

35

20,3x40,6
8,8 mm

55

20,3x20,3
8,8 mm

55

Sviluppo Grafico e Modularità

Pattern by size and modular system. Développement graphique par format et système modulaire.
Grafische Entwicklung und Modularität



Rosado
60,9x60,9
24"x24"
25%

40,6x60,9
16"x24"
33,5%

40,6x40,6
16"x16"
22,2%

20,3x40,6
8"x16"
11%

20,3x20,3
8"x8"
8,3%

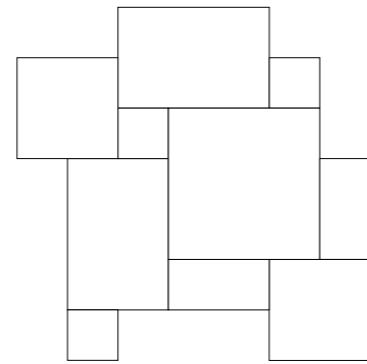

Decorì

Decors

8,8 mm



Capri 20,3x20,3 *
8"x8"
Lucido



Pompei 20,3x20,3 *
8"x8"
Satinato



Fascia 10x40,6 *
4"x16"
Satinato

*** In ogni scatola la combinazione dei soggetti è del tutto casuale. Lo stesso soggetto potrebbe essere ripetuto oppure potrebbe non essere presente nella scatola.**
Each box contains a random assortment of the designs available. The same design may be repeated and certain designs may not be included in the box.
La combinaison des motifs à l'intérieur de chaque boîte est absolument fortuite. Le même motif pourrait être répété ou ne pas se trouver à l'intérieur de la boîte.
Die Zusammenstellung der Motive ist in jedem Karton vollkommen zufällig. Dasselbe Motiv kann mehrfach vorkommen oder im Karton fehlen.



Floor
Rosado 40,6x60,9_16"x24" - 40,6x40,6_16"x16" - 20,3x40,6_8"x16" - 20,3x20,3_8"x8" Nat
Decoro Pompei 20,3x20,3_8"x8" Lucido

Cotto del Casale

| | 8,8 mm | | 8,8 mm | | 8,8 mm | |
|------------|----------------------|----------------------|----------------------|---------------------|--------------------|--|
| | 60,9x60,9 24"x24" | 40,6x60,9 16"x24" | 40,6x40,6 16"x16" | 20,3x40,6 8"x16" | 20,3x20,3 8"x8" | |
| | Nat | | Nat | | Nat | |
| BRUNO | 161004 | 161014 | 161024 | 161034 | 161044 | |
| ROSADO | 161003 | 161013 | 161023 | 161033 | 161043 | |
| OCRA | 161002 | 161012 | 161022 | 161032 | 161042 | |
| GREIGE | 161001 | 161011 | 161021 | 161031 | 161041 | |
| Price code | M083 | M083 | M083 | M083 | M083 | |

| | 8,8 mm | | 8,8 mm | | 8,8 mm | |
|------------|----------------------|----------------------|----------------------|---------------------|--------------------|--|
| | 60,9x60,9 24"x24" | 40,6x60,9 16"x24" | 40,6x40,6 16"x16" | 20,3x40,6 8"x16" | 20,3x20,3 8"x8" | |
| | Nat R11C | | Nat R11C | | Nat R11C | |
| BRUNO | 161007 | 161016 | 161027 | 161037 | 161047 | |
| ROSADO | 161006 | 161015 | 161026 | 161036 | 161046 | |
| Price code | M083 | M083 | M083 | M083 | M083 | |

| | 8,8 mm | | 8,8 mm | |
|------------|------------------------------|-------------------------------|-------------------------------------|--|
| | Capri* 20,3x20,3 8"x8" | Pompei* 20,3x20,3 8"x8" | Pompei Fascia* 10x40,6 4"x12" | |
| | Lucido | Satinato | Satinato | |
| | 161302 | 161301 | 161303 | |
| Price code | CP137 | CP107 | CP125 | |

Pezzi Speciali / Trims. Pièces speciale. Die Sonderstücke

| | 8,8 mm | | 8,8 mm | |
|------------|----------------------------------|--|--|--|
| | Battiscopa Skirting 7x60,9 | Gradino costa retta** Straight nosed stair** 33x60,9 | Gradino costa retta SX - DX** Straight-edge step L-R 33x60,9 | |
| | Nat | | Nat | |
| BRUNO | 161104 | 161204 | 161224SX 161214DX | |
| ROSADO | 161103 | 161203 | 161223SX 161213DX | |
| OCRA | 161102 | 161202 | 161222SX 161212DX | |
| GREIGE | 161101 | 161201 | 161221SX 161211DX | |
| Price code | P021 | P135 | P167 | |

| | 8,8 mm | |
|------------|--|--|
| | Elle monolitico estruso** Extruded L-shaped monoblock tile 15x30x4 | |
| | Nat R11C | |
| BRUNO | 161404 | |
| ROSADO | 161403 | |
| Price code | P050 | |

Calpestio. Foot traffic

• BRUNO LOW • ROSADO, OCRA MEDIUM • GREIGE HIGH



Floor
Greige 60,9x60,9_24"x24" - 40,6x40,6_16"x16" - 20,3x40,6_8"x16" - 20,3x20,3_8"x8" Nat

Imballi / Packings. Emballage. Verpackung

| 8,8 mm | PCS/BOX | MQ/BOX | KG/BOX | BOX/PAL | MQ/PAL | KG/PAL | PACKING | PACKING SIZE |
|-----------------------|---------|--------|--------|---------|--------|--------|---------|----------------|
| 60,9 x 60,9 | 3 | 1,11 | 20,9 | 40 | 44,40 | 836 | EPAL | 80 x 120 x 75h |
| 60,9 x 60,9 R11 | 3 | 1,11 | 20,9 | 40 | 44,40 | 836 | EPAL | 80 x 120 x 75h |
| 40,6 x 60,9 | 6 | 1,48 | 30 | 40 | 59,20 | 1.200 | EPAL | 80 x 120 x 96h |
| 40,6 x 60,9 R11 | 6 | 1,48 | 30 | 40 | 59,20 | 1.200 | EPAL | 80 x 120 x 96h |
| 40,6 x 40,6 | 6 | 0,99 | 18,2 | 72 | 71,28 | 1.308 | EPAL | 80 x 120 x 96h |
| 40,6 x 40,6 R11 | 6 | 0,99 | 18,2 | 72 | 71,28 | 1.308 | EPAL | 80 x 120 x 96h |
| 20,3 x 40,6 | 13 | 1,07 | 19,1 | 72 | 77,04 | 1.375 | EPAL | 80 x 120 x 96h |
| 20,3 x 40,6 R11 | 13 | 1,07 | 19,1 | 72 | 77,04 | 1.375 | EPAL | 80 x 120 x 96h |
| 20,3 x 20,3 | 30 | 1,24 | 22 | 60 | 74,40 | 1.324 | EPAL | 80 x 120 x 96h |
| 20,3 x 20,3 R11 | 30 | 1,24 | 22 | 60 | 74,40 | 1.324 | EPAL | 80 x 120 x 96h |
| DECORI. DECORS | | | | | | | | |
| CAPRI 20,3 x 20,3 * | 6 | 0,24 | 5,65 | - | - | - | EPAL | 80 x 120 |
| POMPEI 20,3 x 20,3 * | 4 | 0,16 | 4,05 | - | - | - | EPAL | 80 x 120 |
| FASCIA 10 x 40,6 * | 4 | 0,16 | 4,10 | - | - | - | EPAL | 80 x 120 |

* Articolo venduto a composizione. In ogni scatola la combinazione dei soggetti è del tutto casuale. Lo stesso soggetto potrebbe essere ripetuto oppure potrebbe non essere presente nella scatola.
Item sold by composition. Each box contains a random assortment of the designs available. The same design may be repeated and certain designs may not be included in the box.
Article vendu par composition. La combinaison des motifs à l'intérieur de chaque boîte est absolument fortuite. Le même motif pourrait être répété ou ne pas se trouver à l'intérieur de la boîte.
Die Zusammenstellung der Motive ist in jedem Karton vollkommen zufällig. Dasselbe Motiv kann mehrfach vorkommen oder im Karton fehlen.

| 8,8 mm | PCS/BOX | MQ/BOX | KG/BOX | BOX/PAL | MQ/PAL | KG/PAL | PACKING | PACKING SIZE |
|---|---------|--------|--------|---------|--------|--------|---------|----------------|
| BATTISCOPIA 7 x 60,9 | 15 | 0,63 | 13,76 | - | - | - | EPAL | 80 x 120 |
| GRADINO COSTA RETTA 33 x 60,9 x 3,2h ** | 4 | - | 20 | - | - | - | EPAL | 80 x 120 |
| GRADINO COSTA RETTA 33 x 60,9 x 3,2h SX/DX ** | 2 | - | 11 | - | - | - | EPAL | 80 x 120 |
| ELLE MONOLITICO ESTRUSO 15 x 30 x 4h ** | 8 | 0,32 | 10,40 | 44 | 14,08 | 477,60 | EPAL | 80 x 120 x 75h |

** A disposizione solo su richiesta. Tempi di consegna: 30gg
Available upon request only. Delivery terms: 30 days
Disponible seulement sur requête. Délais de livraison: 30 Jours
Verfügbar auf Anfrage. Lieferzeit: 30 Tage



Kist MATERICO

CHARCOAL

DARK BLUE

JADE

IVORY

LIGHT GREY

BEIGE



Gres Porcellanato. Porcelain tiles
Grès cérame. Feinsteinzeug
ISO 13006 - G - Bla_E ≤ 0,5%
UNI EN 14411

ANSI A - 326.3: 2021
W E T D Y N A M I C
COEFFICIENT OF FRICTION

DCOF ≥ 0,42



Da pavimento e rivestimento.
For flooring and wall covering. Pour revêtement de sol et mural. Für Boden- und Wandbelag.

9,5 mm INDOOR / OUTDOOR

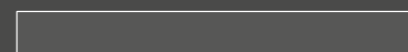

4,8x45
2"x18"
Matte **R10B**

Posare con fuga di 5 mm.
Lay with a 5mm grout line.
Poser avec un joint de 5 mm.
Mit einer 5-mm-Fuge verlegen.

Kist e Kist Lux non posso essere combinati tra loro.
Kist and Kist Lux cannot be combined with each other.
Kist et Kist Lux ne peuvent pas être combinés.
Kist und Kist Lux können nicht miteinander kombiniert werden.

Kist

MATERICO



Sviluppo grafico per formato
Pattern by size
Développement graphique par format
Grafischer Entwurf für Format

4,8x45
9,5 mm

60

NEW SERIES

100% DESIGN AND PRODUCTION OF ITALY



Wall
Jade 4,8x45_2"x18" Matte



Wall
Dark Blue 4,8x45_2"x18" Matte



Wall
Light Grey 4,8x45_2"x18" Matte



charcoal



dark blue



jade



light grey



ivory



beige



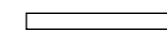



9,5 mm





4,8x45
8"x18"



Angolo incollato
10x35x4,8
4"x13 3/4"x2"

| | Matte | Matte |
|--|--------|--------|
| CHARCOAL  | 264011 | 264111 |
| DARK BLUE  | 264021 | 264121 |
| JADE  | 264041 | 264141 |
| LIGHT GREY  | 264051 | 264151 |
| IVORY  | 264031 | 264131 |
| BEIGE  | 264001 | 264101 |
| Price code | M101 | P040 |

Calpestio . Foot traffic

• CHARCOAL, DARK BLUE, JADE  LOW • LIGHT GREY, BEIGE  MEDIUM • IVORY  HIGH

Imballi / Packings. Emballage. Verpackung

| | PCS/BOX | MQ/BOX | KG/BOX | BOX/PAL | MQ/PAL | KG/PAL | PACKING | PACKING SIZE | TARE (KG) |
|----------------------------|---------|--------|--------|---------|--------|--------|---------|--------------|-----------|
| 9,5 mm 4,8x45 | 32 | 0,77* | 13,2 | 66 | 50,82 | 870 | EPAL | 80 x 120 | 22 |
| Angolo Incollato 10x35x4,8 | 12 | - | - | - | - | - | EPAL | 80 x 120 | 22 |



* Compresa fuga di 5mm. Posare con fuga di 5 mm.
Including a 5mm grout line. Lay with a 5mm grout line.
Y compris un joint de 5 mm. Poser avec un joint de 5 mm.
Einschließlich 5 mm Fuge. Mit einer 5-mm-Fuge verlegen.

Kist Lux

MATERICO



CHARCOAL

DARK BLUE

JADE

IVORY

LIGHT GREY

BEIGE



Gres Porcellanato. Porcelain tiles
Grès cérame. Feinsteinzeug
ISO 13006 - G - Bla_E ≤ 0,5%
UNI EN 14411



Da rivestimento.
Wall tile. Pour revêtement. Für Wandbelag.

9,5 mm INDOOR

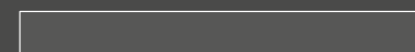

4,8x45
2"x18"
Glossy

Fuga consigliata: minimo 3 mm.
Suggested joint: 3 mm minimum.
Joint conseillé : minimum 3 mm.
Empfohlene Fugenbreite: mindestens 3 mm.

Kist e Kist Lux non posso essere combinati tra loro.
Kist and Kist Lux cannot be combined with each other.
Kist et Kist Lux ne peuvent pas être combinés.
Kist und Kist Lux können nicht miteinander kombiniert werden.

Kist Lux

MATERICO



Sviluppo grafico per formato
Pattern by size
Développement graphique par format
Grafischer Entwurf für Format

4,8x45
9,5 mm
60

NEW SERIES

100% DESIGN AND PRODUCTION OF ITALY



Wall
Ivory 4,8x45_2"x18" Glossy



Wall
Dark Blue 4,8x45_2"x18" Glossy

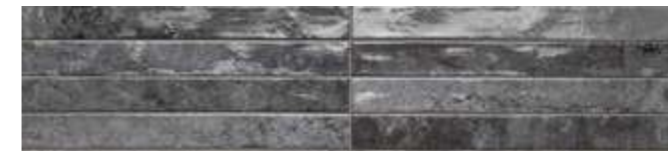

charcoal

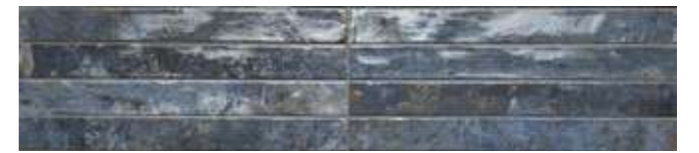

dark blue



jade



light grey



ivory



beige

9,5 mm

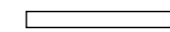

4,8x45
8"x18"

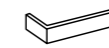

Angolo incollato
10x35x4,8
4"x13 3/4"x2"

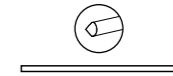

Quarter round
1,4x45
1/2"x18"

| | Glossy | Glossy | Glossy |
|------------|--------|--------|--------|
| CHARCOAL | 264012 | 264112 | 264212 |
| DARK BLUE | 264022 | 264122 | 264222 |
| JADE | 264042 | 264142 | 264242 |
| LIGHT GREY | 264052 | 264152 | 264252 |
| IVORY | 264032 | 264132 | 264232 |
| BEIGE | 264002 | 264102 | 264202 |
| Price code | M111 | P040 | P034 |

Fuga consigliata: minimo 3 mm.
Suggested joint: 3 mm minimum.
Joint conseillé: minimum 3 mm.
Empfohlene Fugenbreite: mindestens 3 mm.

Imballi / Packings. Emballage. Verpackung

| | PCS/BOX | MQ/BOX | KG/BOX | BOX/PAL | MQ/PAL | KG/PAL | PACKING | PACKING SIZE | TARE (KG) |
|----------------------------|---------|--------|--------|---------|--------|--------|---------|--------------|-----------|
| 9,5 mm | | | | | | | | | |
| 4,8x45 | 32 | 0,69 | 13,8 | 66 | 45,54 | 912 | EPAL | 80 x 120 | 22 |
| Angolo Incollato 10x35x4,8 | 12 | - | - | - | - | - | EPAL | 80 x 120 | 22 |
| Quarter Round 1,4x48 | 6 | - | - | - | - | - | EPAL | 80 x 120 | 22 |



Grooves

MATERICO



SAGE

GREY

WHITE

BONE



LOW

SHADE SPECTRUM

Pasta bianca. White body.
Pâte blanche. Weißscherbis.

ISO 13006 B III a
UNI EN 14411



Da rivestimento.
Wall tile. Pour revêtement. Für Wandbelag.

9 mm



7,5x15_3"x6"
Matte | Glossy

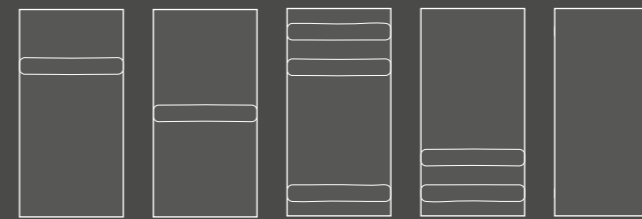

Decor mix
7,5x15_3"x6"
Matte | Glossy



Jolly 1,2x20_1/2"x8"
Matte | Glossy



Grooves



Wall
Sage & Sage Decor Mix 7,5x15_3"x6" Glossy



Wall
Grey & Grey Decor Mix 7,5x15_3"x6" Glossy



Wall
Grey Decor Mix 7,5x15_3"x6" Matt

Grooves

9 mm

SAGE

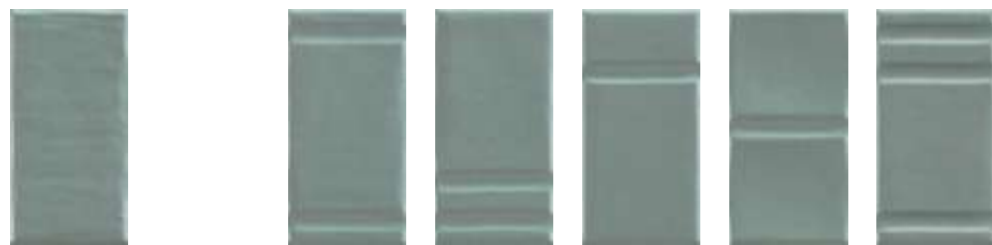

GREY



WHITE



BEIGE



7,5x15_3"x6"
Matte | Glossy

decor mix 7,5x15_3"x6" **
Matte | Glossy

9 mm



7,5x15
3"x6"

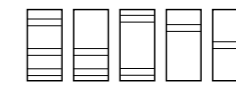

Decor mix **
7,5x15
3"x6"

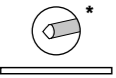

Jolly
1,2x20
1/2"x8"

| | Matte | Glossy | Matte | Glossy | Matte | Glossy |
|------------|--------|--------|--------|--------|--------|--------|
| WHITE | 206002 | 206006 | 206010 | 206014 | 206018 | 206022 |
| BONE | 206004 | 206008 | 206012 | 206016 | 206020 | 206024 |
| GREY | 206003 | 206007 | 206011 | 206015 | 206019 | 206023 |
| SAGE | 206001 | 206005 | 206009 | 206013 | 206017 | 206021 |
| Price code | M097 | M097 | M109 | M109 | P018 | P018 |

* L'area evidenziata indica la superficie smaltata.

The colored area indicates the glazed surface.
La zone colorée indique la surface émaillée.
Die farbige Fläche zeigt die glasierte Oberfläche an.

** In ogni scatola la combinazione dei soggetti è del tutto casuale. Lo stesso soggetto potrebbe essere ripetuto oppure potrebbe non essere presente nella scatola.

Each box contains a random assortment of the designs available. The same design may be repeated and certain designs may not be included in the box.
La combinaison des motifs à l'intérieur de chaque boîte est absolument fortuite. Le même motif pourrait être répété ou ne pas se trouver à l'intérieur de la boîte.
Die Zusammenstellung der Motive ist in jedem Karton vollkommen zufällig. Dasselbe Motiv kann mehrfach vorkommen oder im Karton fehlen.

I rivestimenti hanno bordi naturali. Per ottenere un miglior risultato estetico si consigliano fughe di minimo 2 mm ed una compensazione tra i diversi elementi in fase di installazione, se necessario.

These tiles have natural edges. To obtain the best aesthetic result, we suggest joints of at least 2 mm and, if necessary, a compensation between the different elements during installation.
Ces carreaux ont des bords naturels. Pour obtenir le meilleur résultat esthétique, nous recommandons des joints d'au moins 2 mm et, si nécessaire, un ajustement entre les différents éléments lors de l'installation.
Diese Fliesen haben natürliche Kanten. Für ein optimales ästhetisches Ergebnis empfehlen wir Fugen von mindestens 2 mm und gegebenenfalls eine Anpassung zwischen den verschiedenen Elementen während der Installation.

Imballi / Packings. Emballage. Verpackung

| | PCS/BOX | MQ/BOX | KG/BOX | BOX/PAL | MQ/PAL | KG/PAL | PACKING | PACKING SIZE | TARE (KG) |
|------------------|---------|--------|--------|---------|--------|--------|---------|--------------|-----------|
| 9 mm 7,5x15 | 44 | 0,5 | 6,4 | 120 | 60 | 772 | EPAL | 80 x 120 | 22 |
| 7,5x15 DECOR MIX | 44 | 0,5 | 6,4 | 120 | 60 | 772 | EPAL | 80 x 120 | 22 |
| JOLLY 1,2 x 20 | 22 | 0,05 | 0,9 | - | - | - | EPAL | 80 x 120 | 22 |





Up MATERICO

BLACK

GREY

WHITE

BONE

AVANA

GREEN

BLUE

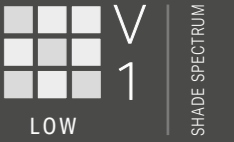

Pasta bianca. White body.
Pâte blanche. Weißscherbis.
ISO 13006 B III a
UNI EN 14411



Da rivestimento.
Wall tile. Pour revêtement. Für Wandbelag.



10x10
4"x4"
Matte
Glossy

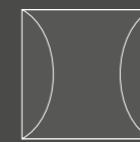

Cuscino 10x10
4"x4"
Matte
Glossy

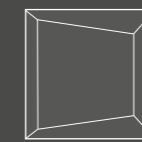

Lingotto 10x10
4"x4"
Matte
Glossy

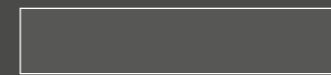

5x25
2"x10"
Matte
Glossy



Cuscino 5x25
2"x10"
Matte
Glossy

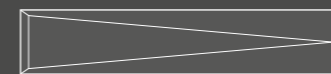

Lingotto 5x25
2"x10"
Matte
Glossy



Cannettato 5x25
2"x10"
Matte
Glossy



Jolly 1,2x20
1/2"x8"
Matte
Glossy

Up

MATERICO



Wall
Black Cuscino 5x25_2"x10" Glossy

Counter Top
Le Malte Sage Nat Ret



Wall
White Cuscino 10x10_4"x4" Matte











Furniture
Statuario Lap





Wall
Green Lingotto 5x25_2"x10" Glossy
Green 5x25_2"x10" Matte

 **Da rivestimento.**
Wall tile. Pour revêtement. Für Wandbelag.

9 mm













| |  |  |  |  |
|---|---|---|---|---|
| | 10x10 4"x4" | 10x10 4"x4" | 5x25 2"x10" | 5x25 2"x10" |
| | Matte | Glossy | Matte | Glossy |
| BLACK  | 192002 | 192012 | 192062 | 192072 |
| GREY  | 192003 | 192013 | 192063 | 192073 |
| WHITE  | 192001 | 192011 | 192061 | 192071 |
| BONE  | 192004 | 192014 | 192064 | 192074 |
| AVANA  | 192005 | 192015 | 192065 | 192075 |
| GREEN  | 192006 | 192016 | 192066 | 192076 |
| BLUE  | 192007 | 192017 | 192067 | 192077 |
| Price code | M097 | M097 | M097 | M097 |











| | Jolly 1,2x20 ½"x8" | Jolly 1,2x20 ½"x8" |
|-------------------|--------------------------|--------------------------|
| | Matte | Glossy |
| | 192142 | 192152 |
| | 192143 | 192153 |
| | 192141 | 192151 |
| | 192144 | 192154 |
| | 192145 | 192155 |
| | 192146 | 192156 |
| | 192147 | 192157 |
| Price code | P018 | P018 |

 **Da rivestimento.**
Wall tile. Pour revêtement. Für Wandbelag.

15 mm

| |  |  |  |  |  |  |
|---|---|---|---|---|---|---|
| | Cuscino 5x25 2"x10" | Cuscino 5x25 2"x10" | Cannettato 5x25 2"x10" | Cannettato 5x25 2"x10" | Lingotto 5x25 2"x10" | Lingotto 5x25 2"x10" |
| | Matte | Glossy | Matte | Glossy | Matte | Glossy |
| BLACK  | 192102 | 192112 | 192122 | 192132 | 192082 | 192092 |
| GREY  | 192103 | 192113 | 192123 | 192133 | 192083 | 192093 |
| WHITE  | 192101 | 192111 | 192121 | 192131 | 192081 | 192091 |
| BONE  | 192104 | 192114 | 192124 | 192134 | 192084 | 192094 |
| AVANA  | 192105 | 192115 | 192125 | 192135 | 192085 | 192095 |
| GREEN  | 192106 | 192116 | 192126 | 192136 | 192086 | 192096 |
| BLUE  | 192107 | 192117 | 192127 | 192137 | 192087 | 192097 |
| Price code | M109 | M109 | M109 | M109 | M109 | M109 |

15 mm

| |  |  |  |  |
|---|---|---|---|---|
| | Lingotto 10x10 4"x4" | Lingotto 10x10 4"x4" | Cuscino 10x10 4"x4" | Cuscino 10x10 4"x4" |
| | Matte | Glossy | Matte | Glossy |
| BLACK  | 192022 | 192032 | 192042 | 192052 |
| GREY  | 192023 | 192033 | 192043 | 192053 |
| WHITE  | 192021 | 192031 | 192041 | 192051 |
| BONE  | 192024 | 192034 | 192044 | 192054 |
| AVANA  | 192025 | 192035 | 192045 | 192055 |
| GREEN  | 192026 | 192036 | 192046 | 192056 |
| BLUE  | 192027 | 192037 | 192047 | 192057 |
| Price code | M109 | M109 | M109 | M109 |

I rivestimenti hanno bordi naturali. Per ottenere un miglior risultato estetico si consigliano fughe di minimo 2 mm ed una compensazione tra i diversi elementi in fase di installazione, se necessario.

These tiles have natural edges. To obtain the best aesthetic result, we suggest joints of at least 2 mm and, if necessary, a compensation between the different elements during installation.

Les revêtements présentent des bords naturels. Pour un plus bel effet esthétique, nous conseillons des joints de 2 mm d'épaisseur minimum et une compensation entre les divers éléments durant la pose si nécessaire.

Die Fliesen haben natürliche Kanten. Für ein besseres ästhetisches Ergebnis empfehlen wir Stöße bzw. Fugen mit mindestens 2 mm Breite und gegebenenfalls einen Ausgleich zwischen den verschiedenen Elementen bei der Verlegung.

Imballi / Packings. Emballage. Verpackung

| | PCS/BOX | MQ/BOX | KG/BOX | BOX /PAL | MQ/PAL | KG/PAL | PACKING | PACKING SIZE | TARE (KG) |
|-------------------|---------|--------|--------|----------|--------|--------|---------|--------------|-----------|
| 9 mm | | | | | | | | | |
| 10 x 10 | 50 | 0,50 | 8,28 | 120 | 60 | 994 | EPAL | 80 x 120 | 22 |
| 5 x 25 | 40 | 0,50 | 6,4 | 112 | 56 | 717 | EPAL | 80 x 120 | 22 |
| JOLLY 1,2 x 20 | 22 | 0,05 | 0,86 | - | - | - | EPAL | 80 x 120 | 22 |
| 15 mm | | | | | | | | | |
| LINGOTTO 10 x 10 | 42 | 0,42 | 7,5 | 120 | 50,4 | 900 | EPAL | 80 x 120 | 22 |
| CUSCINO 10 x 10 | 42 | 0,42 | 7,3 | 120 | 50,4 | 876 | EPAL | 80 x 120 | 22 |
| LINGOTTO 5 x 25 | 36 | 0,45 | 6,2 | 112 | 50,4 | 694 | EPAL | 80 x 120 | 22 |
| CUSCINO 5 x 25 | 32 | 0,40 | 6,2 | 112 | 44,8 | 694 | EPAL | 80 x 120 | 22 |
| CANNETTATO 5 x 25 | 34 | 0,43 | 6,1 | 112 | 48,2 | 683 | EPAL | 80 x 120 | 22 |



Small

MATERICO





WHITE

BLACK

GREY

9 mm

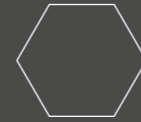

12,4x10,7
5"x4 1/4"
Glossy



10x10
4"x4"
Glossy



6,5x20
2 1/2"x8"
Glossy



5,1x16,1
2"x6 1/3"
Glossy



Jolly 1,2x20
1/2"x8"
Glossy



Pencil bullnose 3x20
1 1/4"x8"
Glossy

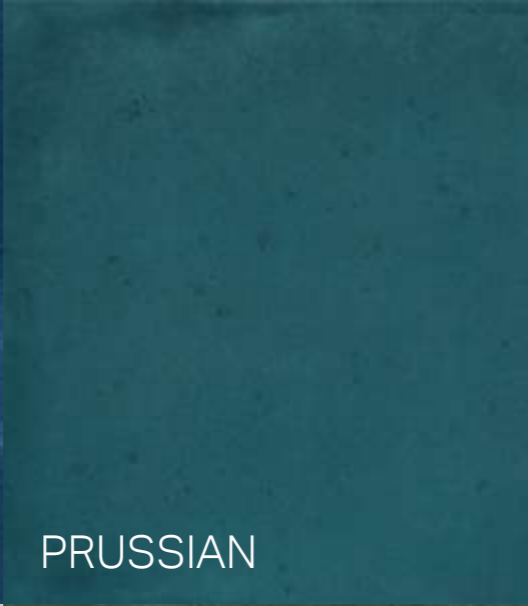

NAVY

PRUSSIAN

LIGHT BLUE

Trend



12,4x10,7
5"x4 1/4"
Glossy

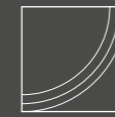

Arco 10x10
4"x4"
Glossy

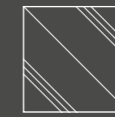

Diagonal 10x10
4"x4"
Glossy

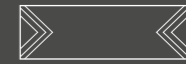

5,1x16,1
2"x6 1/3"
Glossy

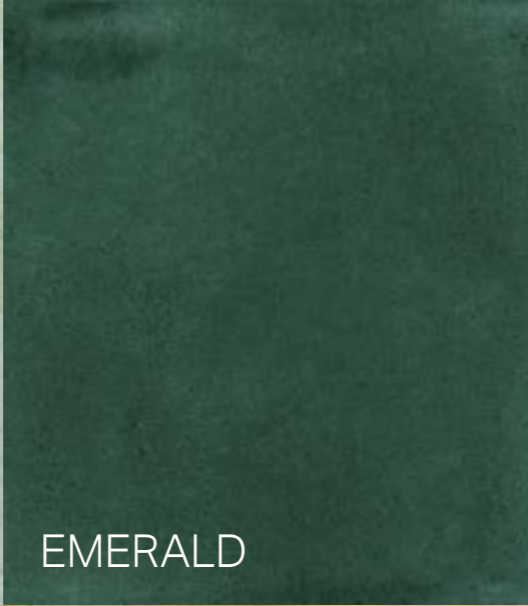

SAGE

EMERALD

FLAMINGO



Sun 6,5x20
2 1/2"x8"
Glossy



Rhombus 6,5x20
2 1/2"x8"
Glossy

Amalfi



12,4x10,7
5"x4 1/4"
Glossy

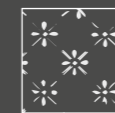

10x10
4"x4"
Glossy



6,5x20
2 1/2"x8"
Glossy



5,1x16,1
2"x6 1/3"
Glossy

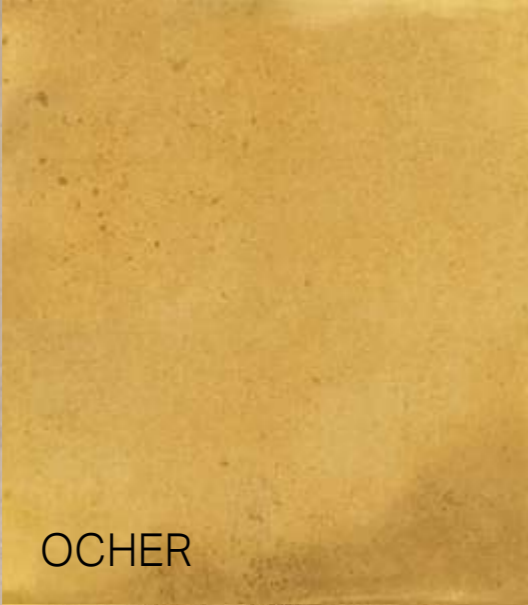

BEIGE

OCHER

PRUNE

Trend

9 mm

BEIGE



OCHER



BLACK



LIGHT BLUE



NAVY



12,4x10,7
5"x4¼"
Glossy

Arco 10x10
4"x4"
Glossy

Diagonal 10x10
4"x4"
Glossy

Rhombus 6,5x20
2½"x8"
Glossy

Sun 6,5x20
2½"x8"
Glossy

5,1x16,1
2"x6⅓"
Glossy



Wall
Light Blue 10x10_4"x4" Glossy

Furniture
Trend Arco Light Blue 10x10_4"x4" Glossy
Prune 10x10_4"x4" Glossy

Amalfi

9 mm

12,4x10,7
5"x4 1/4"
Glossy



10x10
4"x4"
Glossy



6,5x20
2 1/2"x8"
Glossy



5,1x16,1
2"x6 1/8"
Glossy























Backsplash
White 12,4x10,7 5"x4 1/4" Glossy
Amalfi 12,4x10,7 5"x4 1/4" Glossy

Furniture
Ocher 10x10 4"x4" Glossy

Small

 **Da rivestimento.**
Wall tile. Pour revêtement. Für Wandbelag.

| | 9 mm | | | | | |
|--|---|--|--|--|--|--|
| |  12,4x10,7 5"x4¼" |  10x10 4"x4" |  6,5x20 2½"x8" |  5,1x16,1 2"x6½" |  Jolly 1,2x20 ½"x8" |  Pencil bullnose 3x20 1¼"x8" |
| | Glossy | Glossy | Glossy | Glossy | Glossy | Glossy |
| WHITE  | 180048 | 180068 | 180008 | 180028 | 180088 | 180108 |
| BLACK  | 180041 | 180061 | 180001 | 180021 | 180081 | 180101 |
| GREY  | 180053 | 180073 | 180013 | 180033 | 180093 | 180113 |
| NAVY  | 180042 | 180062 | 180002 | 180022 | 180082 | 180102 |
| PRUSSIAN  | 180043 | 180063 | 180003 | 180023 | 180083 | 180103 |
| LIGHT BLUE  | 180047 | 180067 | 180007 | 180027 | 180087 | 180107 |
| SAGE  | 180046 | 180066 | 180006 | 180026 | 180086 | 180106 |
| EMERALD  | 180044 | 180064 | 180004 | 180024 | 180084 | 180104 |
| FLAMINGO  | 180049 | 180069 | 180009 | 180029 | 180089 | 180109 |
| BEIGE  | 180050 | 180070 | 180010 | 180030 | 180090 | 180110 |
| OCHER  | 180051 | 180071 | 180011 | 180031 | 180091 | 180111 |
| PRUNE  | 180052 | 180072 | 180012 | 180032 | 180092 | 180112 |
| Price code | M131 | M097 | M093 | M131 | P018 | P011 |

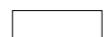
| | 9 mm | | | |
|-------------------|---|--|--|--|
| |  12,4x10,7 5"x4¼" |  10x10 4"x4" |  6,5x20 2½"x8" |  5,1x16,1 2"x6½" |
| | Glossy | Glossy | Glossy | Glossy |
| AMALFI * | 180256 | 180241 | 180206 | 180221 |
| Price code | M141 | M109 | M105 | M141 |

Le tonalità di Amalfi e Trend sono compatibili con i colori dei fondi a tinta unita.

Amalfi and Trend shade could be similar as the plain colour pieces.

Les nuances concernantes Amalfi et Trend sont compatibles avec les fonds.

Die Farbtöne von Amalfi und Trend sind vereinbaren mit die Unifliesen.

I rivestimenti hanno bordi naturali. Per ottenere un miglior risultato estetico si consigliano fughe di minimo 2 mm ed una compensazione tra i diversi elementi in fase di installazione, se necessario.

These tiles have natural edges. To obtain the best aesthetic result, we suggest joints of at least 2 mm and, if necessary, a compensation between the different elements during installation.

Les revêtements présentent des bords naturels. Pour un plus bel effet esthétique, nous conseillons des joints de 2 mm d'épaisseur minimum et une compensation entre les divers éléments durant la pose si nécessaire.











Die Fliesen haben natürliche Kanten. Für ein besseres ästhetisches Ergebnis empfehlen wir Stöße bzw. Fugen mit mindestens 2 mm Breite und gegebenenfalls einen Ausgleich zwischen den verschiedenen Elementen bei der Verlegung.

*** In ogni scatola la combinazione dei soggetti è del tutto casuale. Lo stesso soggetto potrebbe essere ripetuto oppure potrebbe non essere presente nella scatola.**

Each box contains a random assortment of the designs available. The same design may be repeated and certain designs may not be included in the box.

La combinaison des motifs à l'intérieur de chaque boîte est absolument fortuite. Le même motif pourrait être répété ou ne pas se trouver à l'intérieur de la boîte.

Die Zusammenstellung der Motive ist in jedem Karton vollkommen zufällig. Dasselbe Motiv kann mehrfach vorkommen oder im Karton fehlen.

| | 9 mm | | | | | |
|--|---|---|---|--|---|--|
| |  12,4x10,7 5"x4¼" |  Arco 10x10 4"x4" |  Diagonal 10x10 4"x4" |  Rhombus 6,5x20 2½"x8" |  Sun 6,5x20 2½"x8" |  5,1x16,1 2"x6½" |
| | Glossy | Glossy | Glossy | Glossy | Glossy | Glossy |
| TREND BEIGE  | 180251 | 180232 | 180231 | 180212 | 180201 | 180211 |
| TREND OCHER  | 180253 | 180236 | 180235 | 180216 | 180203 | 180215 |
| TREND BLACK  | 180252 | 180234 | 180233 | 180214 | 180202 | 180213 |
| TREND LIGHT BLUE  | 180254 | 180238 | 180237 | 180218 | 180204 | 180217 |
| TREND NAVY  | 180255 | 180240 | 180239 | 180220 | 180205 | 180219 |
| Price code | M141 | M109 | M109 | M105 | M105 | M141 |

Imballi / Packings. Emballage. Verpackung

| | PCS/BOX | MQ/BOX | KG/BOX | BOX/PAL | MQ/PAL | KG/PAL | PACKING | PACKING SIZE |
|------------------------|---------|--------|--------|---------|--------|--------|---------|--------------|
| 9 mm | | | | | | | | |
| 12,4 x 10,7 | 50 | 0,50 | 7,7 | 84 | 42 | 645 | EPAL | 80 x 120 |
| 10 x 10 | 50 | 0,50 | 7,2 | 120 | 60 | 867 | EPAL | 80 x 120 |
| 6,5 x 20 | 38 | 0,50 | 7,7 | 120 | 60 | 930 | EPAL | 80 x 120 |
| 5,1 x 16,1 | 66 | 0,54 | 7,9 | 120 | 64,80 | 954 | EPAL | 80 x 120 |
| JOLLY 1,2 x 20 | 22 | 0,05 | 0,9 | - | - | - | EPAL | 80 x 120 |
| PENCIL BULLNOSE 3 x 20 | 15 | 0,09 | 1,7 | - | - | - | EPAL | 80 x 120 |



Legno

| | |
|----------------------------|-----|
| Honey Wood NEW SIZE | 411 |
| Il Cerreto | 431 |
| Il Cerreto Advance® | 431 |
| Amazon | 439 |
| Ca' Foscari | 447 |
| Kauri | 455 |



*Honey
Wood*

LEGNO

NOCE

ROVERE

OLMO

BRICOLA

LARICE



Gres Porcellanato. Porcelain tiles
Grès cérame. Feinsteinzeug
ISO 13006 - G - Bla_E ≤ 0,5%
UNIEN 14411

ANSI A - 326.3: 2021
W E T D Y N A M I C
COEFFICIENT OF FRICTION

DCOF ≥ 0,42

6 mm



40x240
16"x96"
Nat Ret



24x240
9 1/2"x96"
Nat Ret

NEW SIZE

9,5 mm



Chevron XL 15x85
6"x33 1/2"
Nat [R10B]

8,8 mm



30x120
12"x48"
Nat Ret [R10B]



20x120
8"x48"
Nat Ret [R10B]



7,5x40,7
3"x16"
Nat [R10B]

modular system

La struttura e il tono tra i fondi di spessore 6mm e 8,8mm
potrebbero presentare differenze.

The structure and shade of the tiles with 6 mm and 8.8
mm thickness could show differences.

La structure et la teinte des carreaux de 6 mm et 8,8 mm d'épaisseur
peuvent présenter des différences.

Die Struktur und der Farbton der Fliesen mit einer Dicke von 6 mm und 8,8 mm
könnten Unterschiede aufweisen.

Decor / Decors



Tapparella 20x120
8"x48"
Nat Ret [R10B]



Rombo 30x35
12"x13 3/4"
Nat Ret [R10B]



Inciso 30x30
12"x12"
Nat Ret [R10B]



Rigato 30x30
12"x12"
Nat Ret [R10B]



Spina 30x34
12"x13 1/2"
Nat Ret [R10B]

8,8 mm



20x120
8"x48"
Nat Ret [R11C]

20 mm OUTDOOR

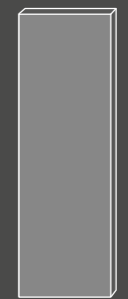

40x120
16"x48"
Nat Ret [R11C]

Honey Wood

LEGNO

100% DESIGN AND PRODUCTION OF ITALY

Sviluppo grafico per formato
Pattern by size
Développement graphique par format
Grafischer Entwurf für Format

| | | | | | | | |
|----------------|----------------|------------------|------------------|--------------------|-----------------|---------------------|-----------------|
| 40x240 6 mm | 24x240 6 mm | 30x120 8,8 mm | 20x120 8,8 mm | 7,5x40,7 8,8 mm | 15x85 9,5 mm | 15x85 Mix 9,5 mm | 40x120 20 mm |
| 9 | 15 | 24 | 36 | 18 | 36 | 108 | 15 |

NOCE 40x240 6 mm



Lo sviluppo grafico mostra solo una selezione dei pattern disponibili. Il numero totale delle grafiche è indicato di seguito.
The graphic development shows only a selection of the available patterns. The total number of patterns is specified below.
Le développement graphique montre uniquement une sélection des motifs disponibles. Le nombre total de motifs est indiqué ci-dessous.
Die grafische Entwicklung zeigt nur eine Auswahl der verfügbaren Muster. Die Gesamtzahl der Muster ist unten angegeben.

PATTERNS 9

ROVERE 40x240 6 mm



Lo sviluppo grafico mostra solo una selezione dei pattern disponibili. Il numero totale delle grafiche è indicato di seguito.
The graphic development shows only a selection of the available patterns. The total number of patterns is specified below.
Le développement graphique montre uniquement une sélection des motifs disponibles. Le nombre total de motifs est indiqué ci-dessous.
Die grafische Entwicklung zeigt nur eine Auswahl der verfügbaren Muster. Die Gesamtzahl der Muster ist unten angegeben.

PATTERNS 9

OLMO 24x240 6 mm



Lo sviluppo grafico mostra solo una selezione dei pattern disponibili. Il numero totale delle grafiche è indicato di seguito.
The graphic development shows only a selection of the available patterns. The total number of patterns is specified below.
Le développement graphique montre uniquement une sélection des motifs disponibles. Le nombre total de motifs est indiqué ci-dessous.
Die grafische Entwicklung zeigt nur eine Auswahl der verfügbaren Muster. Die Gesamtzahl der Muster ist unten angegeben.

PATTERNS 15

BRICOLA 30x120 8,8 mm



Lo sviluppo grafico mostra solo una selezione dei pattern disponibili. Il numero totale delle grafiche è indicato di seguito.
The graphic development shows only a selection of the available patterns. The total number of patterns is specified below.
Le développement graphique montre uniquement une sélection des motifs disponibles. Le nombre total de motifs est indiqué ci-dessous.
Die grafische Entwicklung zeigt nur eine Auswahl der verfügbaren Muster. Die Gesamtzahl der Muster ist unten angegeben.

PATTERNS 24

Sviluppo Grafico

Pattern by size. Développement graphique par format. Grafischer Entwurf für Format.

LARICE 20x120 8,8 mm



Lo sviluppo grafico mostra solo una selezione dei pattern disponibili. Il numero totale delle grafiche è indicato di seguito.
The graphic development shows only a selection of the available patterns. The total number of patterns is specified below.
Le développement graphique montre uniquement une sélection des motifs disponibles. Le nombre total de motifs est indiqué ci-dessous.
Die grafische Entwicklung zeigt nur eine Auswahl der verfügbaren Muster. Die Gesamtzahl der Muster ist unten angegeben.

PATTERNS 36



Backsplash
Tapparella 20x120_8x48" Nat Ret

Counter top
Breccia Argentum Lap

Floor
Larice 30x120_12x48" Nat Ret



Sviluppo Grafico

Pattern by size. Développement graphique par format. Grafischer Entwurf für Format.

CHEVRON MIX 7,5x40,7 8,8 mm



*** Mix di 4 Essenze
Honey Wood: Rovere,
Noce, Bricola e Olmo**
Mix of the 4 Honey Wood
Essences: Rovere, Noce,
Bricola and Olmo
Mélange de 4 essences
Honey Wood: Rovere, Noce,
Bricola et Olmo
Mischung aus 4 Honey
Wood Essenzen: Rovere,
Noce, Bricola und Olmo

CHEVRON XL

9,5 mm PATTERNS 36



15x85
6"x33 1/2"
Nat

CHEVRON XL MIX

9,5 mm PATTERNS 108



MIX
(NOCE, ROVERE, BRICOLA)

15x85
6"x33 1/2"
Nat

Sviluppo Grafico CHEVRON XL MIX

Pattern by size. Développement graphique par format. Grafischer Entwurf für Format.





Wall
Tapparella 20x120_8"x48" Nat Ret

Furniture
Sahara Noir Lap

Decori

Decors

8,8 mm



Inciso 30x30 **
12"x12"
Nat Ret [R10B](#)



Rigato 30x30 **
12"x12"
Nat Ret [R10B](#)



Rombo 30x35 **
12"x13 3/4"
Nat Ret [R10B](#)



Spina 30x34 **
12"x13 1/2"
Nat Ret [R10B](#)

**** Decoro realizzato con il Mix delle 5 Essenze Honey Wood e la serie Statuario.**
 Decoration made with the Mix of the 5 Honey Wood Essences and the Statuario series.
 Décoration réalisée avec le mélange des 5 Essences Honey Wood et la série Statuario.
 Dekor erstellt mit der Mischung der 5 Honey Wood Essenzen und der Serie Statuario.



Tapparella 20x120 *
8"x48"
Nat Ret [R10B](#)

*** Decoro realizzato con il Mix delle 5 Essenze Honey Wood e la serie Pierres des Châteaux Chambord.**
 Decoration made with the Mix of the 5 Honey Wood Essences and the series Pierres des Châteaux Chambord.
 Décoration réalisée avec le mélange des 5 Essences Honey Wood et la série Pierres des Châteaux Chambord.
 Dekor erstellt mit der Mischung der 5 Honey Wood Essenzen und der Serie Pierres des Châteaux Chambord.

Sviluppo Grafico

Pattern by size. Développement graphique par format. Grafischer Entwurf für Format.

OUTDOOR MIX 40x120

20 mm R11C



**Mix di 3 Essenze Honey Wood:
Rovere, Bricola e Olmo**

Mix of the 3 Honey Wood Essences:
Rovere, Bricola and Olmo
Mélange de 3 essences Honey
Wood: Rovere, Bricola et Olmo
Mischung aus 3 Honey Wood
Essenzen: Rovere, Bricola und Olmo

**Lo sviluppo grafico
mostra solo una selezione
dei pattern disponibili.
Il numero totale delle
grafiche è indicato
di seguito.**

The graphic development
shows only a selection
of the available patterns.
The total number of
patterns is specified below.

Le développement graphique
montre uniquement une
sélection des motifs
disponibles. Le nombre
total de motifs est indiqué
ci-dessous.

Die grafische Entwicklung
zeigt nur eine Auswahl
der verfügbaren Muster.
Die Gesamtzahl der Muster
ist unten angegeben.

15 PATTERNS



Floor
Outdoor Mix 40x120_16"x48" Nat Ret

Honey Wood

| 6 mm | | 8,8 mm | | 9,5 mm | | | |
|-------------------|----------------------|-----------------------|-----------------------|--------------------|-----------------------------------|------------|--------|
| 40x240 16"x96" | 24x240 9 1/2"x96" | 30x120 12"x48" | 20x120 8"x48" | 7,5x40,7 3"x16" | Chevron XL 15x85 6"x33 1/2" | | |
| Nat Ret | Nat Ret | Nat Ret [R10B] | Nat Ret [R10B] | Nat [R10B] | Nat [R10B] | | |
| NOCE | 191013 | 191003 | NOCE | 191033 | 191023 | NOCE | 191203 |
| ROVERE | 191011 | 191001 | ROVERE | 191031 | 191021 | ROVERE | 191201 |
| LARICE | 191012 | 191002 | LARICE | 191032 | 191022 | LARICE | - |
| BRICOLA | 191014 | 191004 | BRICOLA | 191034 | 191024 | BRICOLA | 191204 |
| OLMO | 191015 | 191005 | OLMO | 191035 | 191025 | OLMO | - |
| Price code | M141 | M141 | Price code | M093 | M093 | Price code | M107 |

| 8,8 mm | | | | | 9,5 mm |
|------------------------------|------------------------------|---------------------------------|---------------------------------|------------------------------------|--------|
| Rigato * 30x30 12"x12" | Inciso * 30x30 12"x12" | Spina * 30x34 12"x13 1/2" | Rombo * 30x35 12"x13 3/4" | Tapparella *** 20x120 8"x48" | |
| Nat Ret [R10B] | Nat Ret [R10B] | Nat Ret [R10B] | Nat Ret [R10B] | Nat [R10B] | |
| MIX 5 ESSENZE | 191049 | 191050 | 191044 | 191045 | 191048 |
| Price code | M189 | M215 | M189 | M201 | M153 |

| 9,5 mm | |
|------------------------------------|-------------------|
| Chevron XL Mix 15x85_6"x33 1/2" | Nat [R10B] |
| MIX 3 ESSENZE | 191200 |
| BRICOLA ROVERE NOCE | |
| Price code | M107 |

* Decoro realizzato con il Mix delle 5 Essenze Honey Wood e la serie Statuario.
 Decoration made with the Mix of the 5 Honey Wood Essences and the Statuario series.
 Décoration réalisée avec le mélange des 5 Essences Honey Wood et la série Statuario.
 Dekor erstellt mit der Mischung der 5 Honey Wood Essenzen und der Serie Statuario.

*** Decoro realizzato con il Mix delle 5 Essenze Honey Wood e la serie Pierres des Châteaux Chambord.
 Decoration made with the Mix of the 5 Honey Wood Essences and the series Pierres des Châteaux Chambord.
 Décoration réalisée avec le mélange des 5 Essences Honey Wood et la série Pierres des Châteaux Chambord.
 Dekor erstellt mit der Mischung der 5 Honey Wood Essenzen und der Serie Pierres des Châteaux Chambord.

Pezzi Speciali / Trims. Pièces speciale. Die Sonderstücke

| 8,8 mm | | 14 h | |
|------------------------|---|--|------------------------|
| Battiscopa Skirting | Gradino costa retta** Straight nosed stair** | Gradino costa retta SX - DX** Straight-edge step L-R | |
| 6,5x120 | 30x120 | 30x120 | |
| Nat Ret [R10B] | Nat Ret [R10B] | Nat Ret [R10B] | |
| NOCE | 191063 | 191073 | 191083 SX 191093 DX |
| ROVERE | 191061 | 191071 | 191081SX 191091 DX |
| LARICE | 191062 | 191072 | 191082 SX 191092 DX |
| BRICOLA | 191064 | 191074 | 191084 SX 191094 DX |
| OLMO | 191065 | 191075 | 191085 SX 191095 DX |
| Price code | P040 | P207 | P231 |

Pezzi Speciali / Trims. Pièces speciale. Die Sonderstücke

| 8,8 mm | | 20 mm | | 20 mm | | | |
|-----------------------|-----------------------|-------------------------------------|--------------------------------------|-------------------------------------|--------------------------------------|------|--------------------------------------|
| 20x120 8"x48" | 40x120 16"x48" | 40x120 | | 40x120 | | | |
| Nat Ret [R11C] | Nat Ret [R11C] | Costa toro Nat Ret [R11C] | Costa retta Nat Ret [R11C] | Costa toro Nat Ret [R11C] | Costa retta Nat Ret [R11C] | | Costa retta Nat Ret [R11C] |
| NOCE | 191053 | | | | | | |
| ROVERE | 191051 | | | | | | |
| LARICE | 191052 | | | | | | |
| BRICOLA | 191054 | | | | | | |
| OLMO | 191055 | | | | | | |
| Price code | M093 | Price code | M131 | Price code | P219 | P211 | P251 |

| 20 mm | | 20 mm | | | |
|---------------------------|--------|---------------|------|------------------------|------|
| MIX 3 ESSENZE | 191046 | MIX 3 ESSENZE | | 191099 | |
| BRICOLA OLMO ROVERE | | 191096 | | 191100 SX 191101 DX | |
| Price code | M131 | Price code | P219 | P211 | P251 |

Calpestio . Foot traffic

• NOCE, BRICOLA LOW • LARICE, OLMO MEDIUM • ROVERE HIGH

Imballi / Packings. Emballage. Verpackung

| | PCS/BOX | MQ/BOX | KG/BOX | PCS/PAL | BOX/PAL | MQ/PAL | KG/PAL | PACKING | PACKING SIZE | TARE (KG) |
|-------------------------|-------------|--------|--------|---------|---------|--------|--------|-------------|------------------|-----------|
| 6 mm | | | | | | | | | | |
| 40 x 240 | - | - | - | 36 | - | 34,56 | 536 | CASSA LEGNO | 252 x 94 x 30,4h | 85 |
| 24 x 240 | - | - | - | 54 | - | 31,32 | 482 | CASSA LEGNO | 252 x 94 x 30,4h | 85 |
| 8,8 mm | | | | | | | | | | |
| 30 x 120 | 3 | 1,08 | 21 | - | 45 | 48,6 | 943 | EPAL | 80 x 120 x 75h | 22 |
| 20 x 120 | 4 | 0,96 | 18 | - | 60 | 57,6 | 1.077 | EPAL | 80 x 120 x 75h | 22 |
| 20 x 120 R11 | 4 | 0,96 | 18 | - | 60 | 57,6 | 1.077 | EPAL | 80 x 120 x 75h | 22 |
| CHEVRON 7,5 x 40,7 | 14DX - 14SX | 0,88 | 15,8 | - | 42 | 36,96 | 665 | EPAL | 80 x 120 x 75h | 22 |
| DECORI . DECORS | | | | | | | | | | |
| RIGATO 30 x 30 * | 6 | 0,54 | 10,8 | - | 60 | 32,40 | 648 | EPAL | 80 x 120 x 75h | 22 |
| INCISO 30 x 30 * | 6 | 0,54 | 10,8 | - | 60 | 32,40 | 648 | EPAL | 80 x 120 x 75h | 22 |
| SPINA 30 x 34 * | 4 | 0,41 | 12,5 | - | 40 | 16,40 | 500 | EPAL | 80 x 120 x 75h | 22 |
| ROMBO 30 x 35 * | 6 | 0,63 | 12,5 | - | 60 | 37,80 | 750 | EPAL | 80 x 120 x 75h | 22 |
| TAPPARELLA 20 x 120 *** | 4 | 0,96 | 18,6 | - | 30 | 28,80 | 558 | EPAL | 80 x 120 x 75h | 22 |
| 9,5 mm | | | | | | | | | | |
| CHEVRON XL 15x85 | 4DX - 4SX | 1,02 | 21,5 | - | 42 | 42,84 | 905 | EPAL | 80 x 120 x 75h | 22 |
| CHEVRON XL MIX 15x85 | 4DX - 4SX | 1,02 | 21,5 | - | 42 | 42,84 | 905 | EPAL | 80 x 120 x 75h | 22 |
| 20 mm | | | | | | | | | | |
| 40 x 120 | 2 | 0,96 | 41,3 | - | 24 | 23,04 | 991 | EPAL | 80 x 120 x 75h | 22 |



| PEZZI SPECIALI. TRIMS | PCS/BOX | MQ/BOX | KG/BOX | PACKING | PACKING SIZE | TARE (KG) |
|--|---------|--------|--------|---------|--------------|-----------|
| 8,8 mm | | | | | | |
| BATTISCOPA 6,5 x 120 | 6 | 0,46 | 11 | EPAL | 80 x 120 | 22 |
| GRADINO COSTA RETTA 30 x 120 x 4h ** | 2 | - | 20,7 | EPAL | 80 x 120 | 22 |
| GRADINO COSTA RETTA 30 x 120 x 4h SX/DX ** | 1 | - | 10,8 | EPAL | 80 x 120 | 22 |
| 20 mm | | | | | | |
| GRADONE 40 x 120 ** | 1 | - | 22,5 | EPAL | 80 x 120 | 22 |
| GRADONE 40 x 120 SX/DX ** | 1 | - | 22,5 | EPAL | 80 x 120 | 22 |

** A disposizione solo su richiesta.
 Tempi di consegna: 30gg
 Available upon request only.
 Delivery terms: 30 days
 Disponible seulement sur requête.
 Délais de livraison: 30 jours
 Verfügbar auf Anfrage.
 Lieferzeit: 30 Tage



Il Cerreto
LEGNO

PINOT GRIGIO

CHAMPAGNE

SOAVE

CHARDONNAY

AMARONE



Gres Porcellanato. Porcelain tiles
Grès cérame. Feinsteinzeug
ISO 13006 - G - Bla_E ≤ 0,5%
UNI EN 14411

ANSI A - 326.3: 2021
W E T - D Y N A M I C
COEFFICIENT OF FRICTION

DCOF ≥ 0,42

8,8 mm



23,4x148
9 1/8"x58 1/4"
Nat Ret **R10B**



30x120
12"x48"
Nat Ret **R10B**



20x120
8"x48"
Nat Ret **R10B**

modular system

Formati disponibili con la tecnologia ADVANCE®. Per info consulta pag. 500.
ADVANCE® technology available sizes. For more info go to page 500.
Formats disponibles avec la technologie ADVANCE®. Pour toutes informations aller à la page 500.
Verfügbare Größen mit ADVANCE®-Technologie. Für weitere Infos siehe S. 500.

Decor / Decors

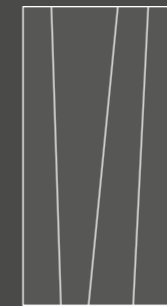

4 PATTERNS



Chrome 60x120
24"x48"
Nat Ret **R10B**

Rete esagonale 30x26
12"x10 1/4"
Nat Ret **R10B**

8,8 mm



20x120
8"x48"
Nat Ret **R11C**

Champagne
Chardonnay

20 mm OUTDOOR

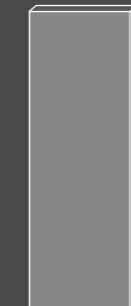

40x120
16"x48"
Nat Ret **R11C**

Il Cerreto

LEGNO

100% DESIGN AND PRODUCTION OF ITALY

Sviluppo grafico per formato
Pattern by size
Développement graphique par format
Grafischer Entwurf für Format

23,4x148
8,8 mm

21

30x120
8,8 mm

14

20x120
8,8 mm

21

40x120
20 mm

12

Sviluppo Grafico

Pattern by size. Développement graphique par format. Grafischer Entwurf für Format

8,8 mm

CHARDONNAY 20x120



Lo sviluppo grafico mostra solo una selezione dei pattern disponibili. Il numero totale delle grafiche è indicato di seguito.
The graphic development shows only a selection of the available patterns. The total number of patterns is specified below.
Le développement graphique montre uniquement une sélection des motifs disponibles. Le nombre total de motifs est indiqué ci-dessous.
Die grafische Entwicklung zeigt nur eine Auswahl der verfügbaren Muster. Die Gesamtzahl der Muster ist unten angegeben.

PATTERNS 21

Decori

Decors

8,8 mm

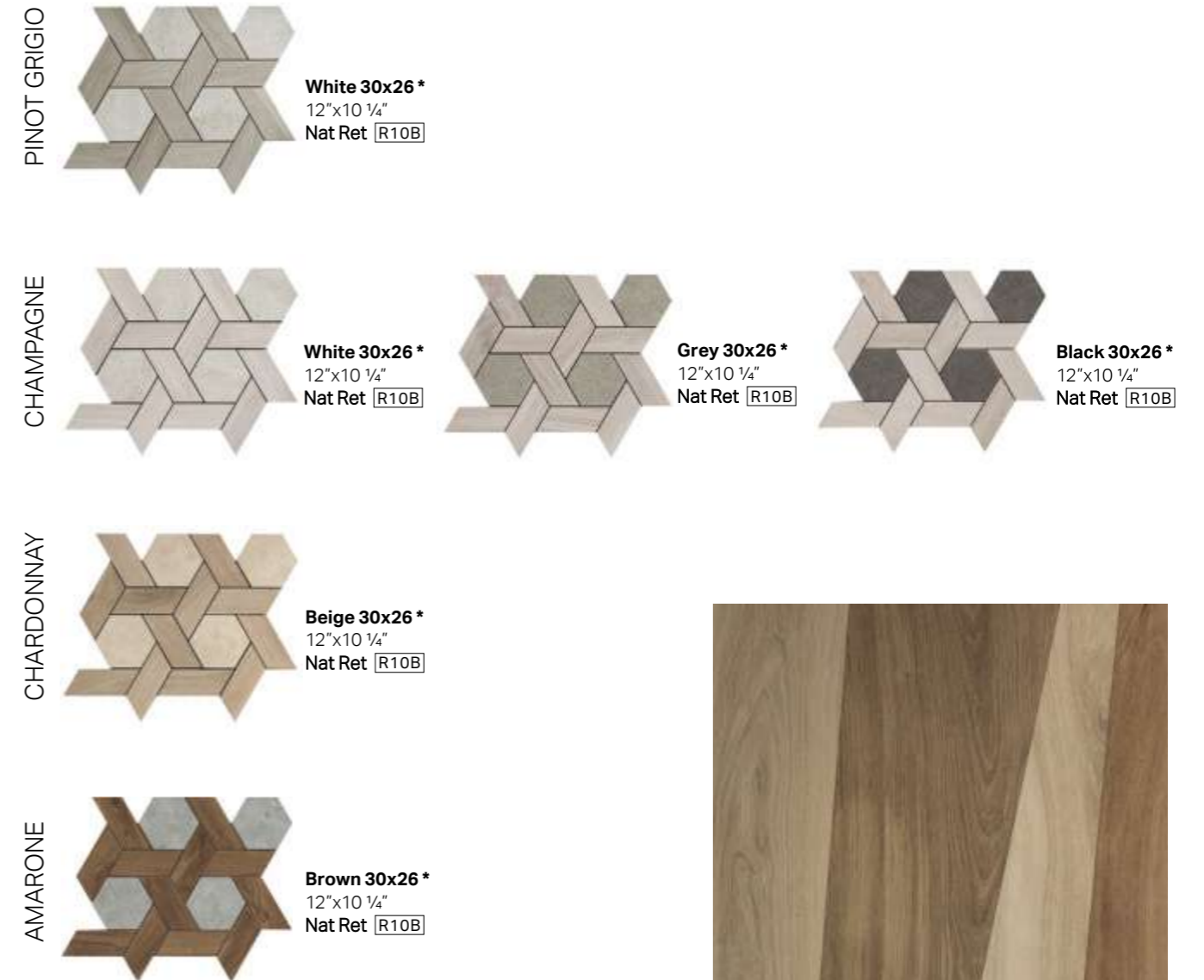

*Decoro realizzato con la serie Pierres des Châteaux e Il Cerreto.
Decoration made with Pierres des Châteaux and Il Cerreto series.
Décor composé de Pierres des Châteaux et Il Cerreto séries.
Dekor mit der Serie Pierres des Châteaux und Il Cerreto ausgeführt.



Chrome 60x120
24"x48"
Nat Ret R10B

PATTERNS 4

Il Cerreto

Il Cerreto

| 8,8 mm | | | | | 8,8 mm | | | | | 20 mm | | |
|----------------------------|--------|----------------|--------|--------|-------------------|--------|------------------|--|------------------|-------|-------------------|--|
| 23,4x148 9 1/8"x58 1/4" | | | | | 30x120 12"x48" | | 20x120 8"x48" | | 20x120 8"x48" | | 40x120 16"x48" | |
| Nat Ret [R10B] | | Nat Ret [R10B] | | | Nat Ret [R10B] | | Nat Ret [R10B] | | Nat Ret [R11C] | | Nat Ret [R11C] | |
| PINOT GRIGIO | 157028 | 157049 | 157013 | 157023 | PINOT GRIGIO | - | 157033 | | | | | |
| CHAMPAGNE | 157029 | 157050 | 157014 | 157024 | CHAMPAGNE | 157054 | 157034 | | | | | |
| SOAVE | 157027 | 157048 | 157012 | 157022 | SOAVE | - | - | | | | | |
| CHARDONNAY | 157025 | 157046 | 157010 | 157020 | CHARDONNAY | 157055 | 157030 | | | | | |
| AMARONE | 157026 | 157047 | 157011 | 157021 | AMARONE | - | 157031 | | | | | |
| Price code | M101 | M119 | M093 | M093 | Price code | M093 | M131 | | | | | |

| 8,8 mm | | 8,8 mm | |
|---|-------------------------------|-----------------------------|--|
| Rete esagonale* 30x26 12"x10 1/4" | | Chrome 60x120 24"x48" | |
| Nat Ret [R10B] | | Nat Ret [R10B] | |
| PINOT GRIGIO | MOSCP01 | 157090 | |
| CHAMPAGNE | MOSCP04 MOSCP05 MOSCP06 | | |
| SOAVE | - | | |
| CHARDONNAY | MOSCP02 | | |
| AMARONE | MOSCP03 | | |
| Price code | M287 | M097 | |

 Formati disponibili con la tecnologia ADVANCE®. Per info consulta pag. 500.
 ADVANCE® technology available sizes. For more info go to page 500.
 Formats disponibles avec la technologie ADVANCE®. Pour toutes informations aller à la page 500.
 Verfügbare Größen mit ADVANCE®-Technologie. Für weitere Infos siehe S. 500.

Pezzi Speciali / Trims. Pièces speciale. Die Sonderstücke

| 8,8 mm | | 8,8 mm | | | | 20 mm | | |
|------------------------|--------|---|--------|---|------------------------|---------------------------------------|--------------|--------|
| Battiscopa Skirting | | Gradino costa retta** Straight nosed stair** | | Gradino costa retta SX - DX** Straight-edge step L-R | | Gradone costa toro** Large step | | |
| 6,5x120 | | 6,5x148 | | 33x120 | | 33x120 | | |
| Nat Ret [R10B] | | Nat Ret [R10B] | | Nat Ret [R10B] | | Nat Ret [R11C] | | |
| PINOT GRIGIO | 157104 | 157114 | 157204 | 157209 | 157224 SX 157214 DX | 157219 DX 157229 SX | PINOT GRIGIO | 157404 |
| CHAMPAGNE | 157101 | 157111 | 157201 | 157206 | 157221 SX 157211 DX | 157216 DX 157226 SX | CHAMPAGNE | 157401 |
| SOAVE | 157102 | 157112 | 157202 | 157207 | 157222 SX 157212 DX | 157217 DX 157227 SX | SOAVE | - |
| CHARDONNAY | 157103 | 157113 | 157203 | 157208 | 157223 SX 157213 DX | 157218 DX 157228 SX | CHARDONNAY | 157403 |
| AMARONE | 157105 | 157115 | 157205 | 157210 | 157225 SX 157215 DX | 157220 DX 157230 SX | AMARONE | 157405 |
| Price code | P040 | P046 | P207 | P235 | P231 | P282 | Price code | P219 |

Calpestio . Foot traffic

• PINOT GRIGIO, AMARONE  LOW • CHARDONNAY, SOAVE  MEDIUM • CHAMPAGNE  HIGH



Floor
Chardonnay 40x120_16"x48" Nat Ret 20 mm R11

Imballi / Packings. Emballage. Verpackung

| | PCS/BOX | MQ/BOX | KG/BOX | BOX/PAL | MQ/PAL | KG/PAL | PACKING | PACKING SIZE |
|--------------------------|---------|--------|--------|---------|--------|--------|---------|--------------------|
| 8,8 mm | | | | | | | | |
| 23,4 x 148 | 3 | 1,04 | 20,7 | 48 | 49,92 | 996 | PALLET | 152 x 77,6 x 16,1h |
| 30 x 120 | 3 | 1,08 | 20,4 | 45 | 48,60 | 918 | EPAL | 80 x 120 x 75h |
| 20 x 120 | 4 | 0,96 | 20,3 | 60 | 57,60 | 1.219 | EPAL | 80 x 120 x 75h |
| 20 x 120 R11 | 4 | 0,96 | 20,3 | 60 | 57,60 | 1.219 | EPAL | 80 x 120 x 75h |
| DECORI. DECORS | | | | | | | | |
| CHROME 60 x 120 | 2 | 1,44 | 27,5 | 32 | 46,08 | 881 | EPAL | 80 x 120 x 75h |
| RETE ESAGONALE 30 x 26 * | 6 | 0,47 | 10,74 | 60 | 28,20 | 644 | EPAL | 80 x 120 x 75h |
| 20 mm | | | | | | | | |
| 40 x 120 | 2 | 0,96 | 43,01 | 24 | 23,04 | 1.032 | EPAL | 80 x 120 x 75h |

 Epal / Pallet

| PEZZI SPECIALI. TRIMS | PCS/BOX | MQ/BOX | KG/BOX | PACKING | PACKING SIZE |
|--|---------|--------|--------|---------|--------------|
| 8,8 mm | | | | | |
| BATTISCOPIA 6,5 x 120 | 6 | - | 9,94 | EPAL | 80 x 120 |
| BATTISCOPIA 6,5 x 148 | 6 | - | 9,94 | EPAL | 80 x 120 |
| GRADINO COSTA RETTA 33 x 120 x 3,2h** | 2 | - | 20,70 | EPAL | 80 x 120 |
| GRADINO COSTA RETTA 33 x 120 x 3,2h SX/DX ** | 1 | - | 10,80 | EPAL | 80 x 120 |
| 20 mm | | | | | |
| GRADONE 40 x 120 ** | 1 | - | 22,50 | EPAL | 80 x 120 |

* Decoro realizzato con la serie Pierres des Châteaux e Il Cerreto.
 Decoration made with Pierres des Châteaux and Il Cerreto series.
 Décor composé de Pierres des Châteaux et Il Cerreto séries.
 Dekor mit der Serie Pierres des Châteaux und Il Cerreto ausgeführt.

** A disposizione solo su richiesta. Tempi di consegna: 30gg
 Available upon request only. Delivery terms: 30 days
 Disponible seulement sur requête. Délais de livraison: 30 jours
 Verfügbar auf Anfrage. Lieferzeit: 30 Tage



Amazon

LEGNO

NAWA

KAMBA

ARARA

MATIS

SURMA

8,8 mm



20x120
8"x48"
Nat Ret **R10B**



7,5x40,7
3"x16"
Nat **R10B**



7,5x45
3"x18"
Nat **R10B**

20 mm OUTDOOR



40x120
16"x48"
Nat Ret **R11C**



Gres Porcellanato. Porcelain tiles
Grès cérame. Feinsteinzeug
ISO 13006 - G - Bla_E ≤ 0,5%
UNI EN 14411

ANSI A - 326.3: 2021
W E T - D Y N A M I C
C O E F F I C I E N T O F F R I C T I O N

DCOF ≥ 0,42

Amazon

LEGNO

100% DESIGN AND PRODUCTION OF ITALY

Sviluppo grafico per formato
Pattern by size
Développement graphique par format
Grafischer Entwurf für Format

20x120
8,8 mm

42

7,5x40,7
8,8 mm

11

7,5x45
8,8 mm

11

40x120
20 mm

14

Sviluppo Grafico

Pattern by size. Développement graphique par format. Grafischer Entwurf für Format.

KAMBA 20x120 8,8 mm



Lo sviluppo grafico mostra solo una selezione dei pattern disponibili. Il numero totale delle grafiche è indicato di seguito.
The graphic development shows only a selection of the available patterns. The total number of patterns is specified below.
Le développement graphique montre uniquement une sélection des motifs disponibles. Le nombre total de motifs est indiqué ci-dessous.
Die grafische Entwicklung zeigt nur eine Auswahl der verfügbaren Muster. Die Gesamtzahl der Muster ist unten angegeben.

PATTERNS 42



Floor
Matis 20x120_8"x48" Nat Ret

Amazon

8,8 mm



20x120
8"x48"



7,5x40,7
3"x16"



7,5x45
3"x18"

| | Nat Ret R10B | Nat R10B | Nat R10B |
|------------|---------------------|-----------------|-----------------|
| NAWA | 076035 | 076608 | 076604 |
| KAMBA | 076031 | 076606 | 076602 |
| ARARA | 076029 | 076605 | 076601 |
| MATIS | 076033 | 076607 | 076603 |
| SURMA | 076038 | - | - |
| Price code | M093 | M107 | M091 |

20 mm



40x120
16"x48"

| | Nat Ret R11C |
|------------|---------------------|
| NAWA | 076021 |
| KAMBA | 076017 |
| ARARA | 076015 |
| MATIS | 076019 |
| SURMA | 076024 |
| Price code | M131 |

Pezzi Speciali / Trims. Pièces speciale. Die Sonderstücke

8,8 mm



Battiscopa
Skirting

6,5x120

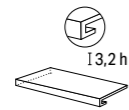

Gradino costa retta**
Straight nosed stair**

33x120

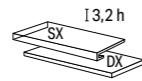

Gradino costa retta SX - DX**
Straight-edge step L-R

33x120

| | Nat Ret R10B | Nat Ret R10B | Nat Ret R10B |
|------------|---------------------|---------------------|------------------------|
| NAWA | 076106 | 076076 | 076096 SX 076086 DX |
| KAMBA | 076102 | 076072 | 076092 SX 076082 DX |
| ARARA | 076100 | 076070 | 076090 SX 076080 DX |
| MATIS | 076104 | 076074 | 076094 SX 076084 DX |
| SURMA | 076110 | 076077 | 076095 SX 076087 DX |
| Price code | P040 | P207 | P231 |

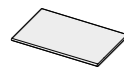

Gradone**
Large step

40x120

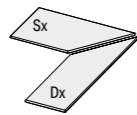

Gradone Angolo Sx/Dx**
Large step - Corner L/R

40x120

20 mm

| | Costa toro Nat Ret R11C | Costa retta Nat Ret R11C | Costa toro Nat Ret R11C | Costa retta Nat Ret R11C |
|------------|-----------------------------------|------------------------------------|-----------------------------------|------------------------------------|
| NAWA | 076141 | 076133 | 076157 DX 076173 SX | 076149 DX 076165 SX |
| KAMBA | 076139 | 076131 | 076155 DX 076171 SX | 076147 DX 076163 SX |
| ARARA | 076138 | 076130 | 076154 DX 076170 SX | 076146 DX 076162 SX |
| MATIS | 076140 | 076132 | 076156 DX 076172 SX | 076148 DX 076164 SX |
| SURMA | 076143 | 076135 | 076159 DX 076175 SX | 076151 DX 076167 SX |
| Price code | P219 | P211 | P251 | P239 |

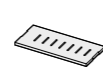

Griglia**
Drainage grid

20x60
R11C

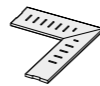

Griglia Angolo Sx/Dx**
Drainage grid - Corner L/R

20x60
R11C

| | |
|--------|------------------------|
| 076437 | 076453 SX 076445 DX |
| 076435 | 076451 SX 076443 DX |
| 076434 | 076450 SX 076442 DX |
| 076436 | 076452 SX 076444 DX |
| 076439 | 076457 SX 076447 DX |
| P205 | P205 |

La gamma completa dei pezzi speciali è disponibile nella "PARTE TECNICA" del catalogo a pag. 537

Our entire range of trims is available in our "TECHNICAL SECTION" of this catalogue pag. 537.

La gamme complète des pièces spéciales est disponible dans la section "PARTIE TECHNIQUE" à la pag. 537 de ce catalogue.

Das komplette Sortiment an Sonderstücken ist in dem "technischen Teil" des Katalogs auf Seite 537 verfügbar.

Calpestio . Foot traffic

• NAWA, KAMBA, MATIS, SURMA MEDIUM • ARARA HIGH



Floor
Kamba Chevron 7,5x40,7_3"x16" Nat
Kamba Listello 7,5x45_3"x18" Nat

Imballi / Packings. Emballage. Verpackung

| | PCS/BOX | MQ/BOX | KG/BOX | BOX/PAL | MQ/PAL | KG/PAL | PACKING | PACKING SIZE |
|--------------------|-------------|--------|--------|---------|--------|--------|---------|----------------|
| 8,8 mm | | | | | | | | |
| 20 x 120 | 4 | 0,96 | 18 | 60 | 57,60 | 1.084 | EPAL | 80 x 120 x 75h |
| CHEVRON 7,5 x 40,7 | 14DX - 14SX | 0,88 | 15,7 | 42 | 36,96 | 659 | EPAL | 80 x 120 x 75h |
| LISTELLO 7,5 x 45 | 28 | 0,95 | 18,2 | 42 | 39,9 | 764 | EPAL | 80 x 120 x 75h |
| 20 mm | | | | | | | | |
| 40 x 120 | 2 | 0,96 | 42,7 | 24 | 23,04 | 1.025 | EPAL | 80 x 120 x 75h |



| PEZZI SPECIALI. TRIMS | PCS/BOX | MQ/BOX | KG/BOX | PACKING | PACKING SIZE |
|---|---------|--------|--------|---------|--------------|
| 8,8 mm | | | | | |
| BATTISCOPA 6,5 x 120 | 6 | - | 11,04 | EPAL | 80 x 120 |
| GRADINO COSTA RETTA 33 x 120 x 3,2h** | 2 | - | 23 | EPAL | 80 x 120 |
| GRADINO COSTA RETTA 33 x 120 x 3,2h SX/DX** | 1 | - | 12 | EPAL | 80 x 120 |
| 20 mm | | | | | |
| GRADONE 40 x 120** | 1 | - | 22,50 | EPAL | 80 x 120 |
| GRADONE 40 x 120 SX/DX** | 1 | - | 22,50 | EPAL | 80 x 120 |
| GRIGLIA 20 x 60** | 1 | - | 6,00 | EPAL | 80 x 120 |
| GRIGLIA 20 x 60 SX/DX** | 1 | - | 6,00 | EPAL | 80 x 120 |

**** A disposizione solo su richiesta. Tempi di consegna: 30gg**
Available upon request only. Delivery terms: 30 days
Disponible seulement sur requête. Délais de livraison: 30 jours
Verfügbar auf Anfrage. Lieferzeit: 30 Tage



Ca' Foscarini

LEGNO

LINO

CANAPA

AVANA

TABACCO

MORO



Gres Porcellanato. Porcelain tiles
Grès cérame. Feinsteinzeug
ISO 13006 - G - Bla_E ≤ 0,5%
UNI EN 14411

ANSI A - 326.3: 2021
W E T - D Y N A M I C
COEFFICIENT OF FRICTION

DCOF ≥ 0,42

8,8 mm



20x120
8"x48"
Nat Ret R10A



7,5x40,7
3"x16"
Nat R10A



7,5x45
3"x18"
Nat R10A

8,8 mm



20x120
8"x48"
Nat Ret R11C

20 mm OUTDOOR



40x120
16"x48"
Nat Ret R11C

Ca' Foscari

LEGNO

100% DESIGN AND PRODUCTION OF ITALY

Sviluppo grafico per formato
Pattern by size
Développement graphique par format
Grafischer Entwurf für Format

20x120
8,8 mm
30

7,5x40,7
8,8 mm
40

7,5x45
8,8 mm
40

40x120
20 mm
12

Ca' Foscari

CANAPA 20x120 8,8 mm



Lo sviluppo grafico mostra solo una selezione dei pattern disponibili. Il numero totale delle grafiche è indicato di seguito.
The graphic development shows only a selection of the available patterns. The total number of patterns is specified below.
Le développement graphique montre uniquement une sélection des motifs disponibles. Le nombre total de motifs est indiqué ci-dessous.
Die grafische Entwicklung zeigt nur eine Auswahl der verfügbaren Muster. Die Gesamtzahl der Muster ist unten angegeben.

PATTERNS 30



Floor
Moro 40x120_16"x48" Nat Ret 20mm R11

Ca' Foscari

8,8 mm

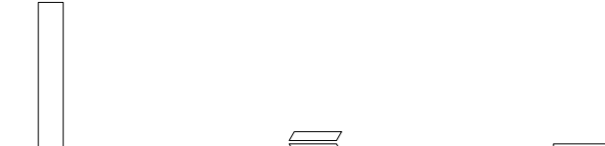

| | 20x120 8"x48" | 7,5x40,7 3"x16" | 7,5x45 3"x18" |
|-------------------|---------------------|--------------------|------------------|
| | Nat Ret R10A | Nat R10A | Nat R10A |
| LINO | 094001 | 094105 | 094101 |
| CANAPA | 094005 | 094106 | 094102 |
| AVANA | 094009 | 094107 | 094103 |
| TABACCO | 094013 | 094108 | 094104 |
| MORO | 094017 | - | - |
| Price code | M093 | M107 | M091 |

8,8 mm



20 mm



| | 20x120 8"x48" | 40x120 16"x48" |
|-------------------|---------------------|---------------------|
| | Nat Ret R11C | Nat Ret R11C |
| LINO | 094002 | 094031 |
| CANAPA | 094006 | 094032 |
| AVANA | 094010 | 094033 |
| TABACCO | 094014 | 094034 |
| MORO | 094018 | 094035 |
| Price code | M093 | M131 |

20 mm

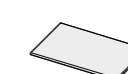

Gradone**
Large step

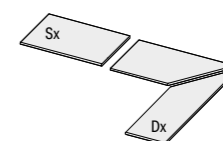

Gradone Angolo Sx/Dx**
Large step - Corner L/R

| | 40x120 | | 40x120 | |
|-------------------|-----------------------------------|------------------------------------|-----------------------------------|------------------------------------|
| | Costa toro Nat Ret R11C | Costa retta Nat Ret R11C | Costa toro Nat Ret R11C | Costa retta Nat Ret R11C |
| LINO | 094327 | 094320 | 094355 SX 094341 DX | 094348 SX 094334 DX |
| CANAPA | 094328 | 094321 | 094356 SX 094342 DX | 094349 SX 094335 DX |
| AVANA | 094329 | 094322 | 094357 SX 094343 DX | 094350 SX 094336 DX |
| TABACCO | 094330 | 094323 | 094358 SX 094344 DX | 094351 SX 094337 DX |
| MORO | 094331 | 094324 | 094359 SX 094345 DX | 094352 SX 094338 DX |
| Price code | P219 | P211 | P251 | P239 |

20 mm



Griglia**
Drainage grid

20x60
R11C

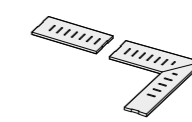

Griglia Angolo Sx/Dx**
Drainage grid - Corner L/R

20x60
R11C

| | | |
|-------------------|-------------|------------------------|
| LINO | 094256 | 094270 SX 094263 DX |
| CANAPA | 094257 | 094271 SX 094264 DX |
| AVANA | 094258 | 094272 SX 094265 DX |
| TABACCO | 094259 | 094273 SX 094266 DX |
| MORO | 094260 | 094274 SX 094267 DX |
| Price code | P205 | P205 |

La gamma completa dei pezzi speciali è disponibile nella "PARTE TECNICA" del catalogo a pag. 537
Our entire range of trims is available in our "TECHNICAL SECTION" of this catalogue pag. 537.
La gamme complète des pièces spéciales est disponible dans la section "PARTIE TECHNIQUE" à la pag. 537 de ce catalogue.
Das komplette Sortiment an Sonderstücken ist in dem "technischen Teil" des Katalogs auf Seite 537 verfügbar.

Calpestio . Foot traffic

• TABACCO, MORO  LOW • AVANA  MEDIUM • LINO, CANAPA  HIGH

Pezzi Speciali / Trims. Pièces speciale. Die Sonderstücke

8,8 mm



Battiscopa
Skirting

6,5x120

Nat Ret **R10A**

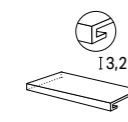

Gradino costa retta**
Straight nosed stair**

33x120

Nat Ret **R10A**

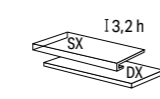

Gradino costa retta SX - DX**
Straight-edge step L-R

33x120

Nat Ret **R10A**

| | | | |
|-------------------|-------------|-------------|------------------------|
| LINO | 094090 | 094060 | 094080 SX 094070 DX |
| CANAPA | 094091 | 094061 | 094081 SX 094071 DX |
| AVANA | 094092 | 094062 | 094082 SX 094072 DX |
| TABACCO | 094093 | 094063 | 094083 SX 094073 DX |
| MORO | 094094 | 094064 | 094084 SX 094074DX |
| Price code | P040 | P207 | P231 |

Imballi / Packings. Emballage. Verpackung

| | PCS/BOX | MQ/BOX | KG/BOX | BOX/PAL | MQ/PAL | KG/PAL | PACKING | PACKING SIZE |
|--------------------|-------------|--------|--------|---------|--------|--------|---------|----------------|
| 8,8 mm | | | | | | | | |
| 20 x 120 | 4 | 0,96 | 18,2 | 48 | 46,08 | 873 | EPAL | 80 x 120 x 70h |
| 20 x 120 R11 | 4 | 0,96 | 18,2 | 48 | 46,08 | 873 | EPAL | 80 x 120 x 70h |
| CHEVRON 7,5 x 40,7 | 14DX - 14SX | 0,88 | 15,7 | 42 | 36,96 | 659 | EPAL | 80 x 120 x 75h |
| LISTELLO 7,5 x 45 | 28 | 0,95 | 18,2 | 42 | 39,9 | 764 | EPAL | 80 x 120 x 75h |
| 20 mm | | | | | | | | |
| 40 x 120 | 2 | 0,96 | 42,7 | 24 | 23,04 | 1.032 | EPAL | 80 x 120 x 75h |

| PEZZI SPECIALI. TRIMS | PCS/BOX | MQ/BOX | KG/BOX | PACKING | PACKING SIZE |
|--|---------|--------|--------|---------|--------------|
| 8,8 mm | | | | | |
| BATTISCOPA 6,5 x 120 | 6 | - | 11,04 | EPAL | 80 x 120 |
| GRADINO COSTA RETTA 33 x 120 x 3,2h ** | 2 | - | 23,00 | EPAL | 80 x 120 |
| GRADINO COSTA RETTA 33 x 120 x 3,2h SX/DX ** | 1 | - | 12,00 | EPAL | 80 x 120 |
| 20 mm | | | | | |
| GRADONE 40 x 120 ** | 1 | - | 22,50 | EPAL | 80 x 120 |
| GRADONE 40 x 120 SX/DX ** | 1 | - | 22,50 | EPAL | 80 x 120 |
| GRIGLIA 20 x 60 ** | 1 | - | 6,00 | EPAL | 80 x 120 |
| GRIGLIA 20 x 60 SX/DX ** | 1 | - | 5,50 | EPAL | 80 x 120 |

** A disposizione solo su richiesta. Tempi di consegna: 30gg
Available upon request only. Delivery terms: 30 days
Disponible seulement sur requête. Délais de livraison: 30 jours
Verfügbar auf Anfrage. Lieferzeit: 30 Tage

Kauri

LEGNO



VICTORIA

TASMAN

NELSON

AWANUI

CATLINS

FIORDLAND



Gres Porcellanato. Porcelain tiles
Grès cérame. Feinsteinzeug
ISO 13006 - G - Bla_E ≤ 0,5%
UNIEN 14411

ANSI A - 326.3: 2021
W E T - D Y N A M I C
COEFFICIENT OF FRICTION

DCOF ≥ 0,42 | naturale

8,8 mm



20x120
8"x48"
Nat Ret [R10A]
Lap Ret



7,5x40,7
3"x16"
Nat [R10A]



7,5x45
3"x18"
Nat [R10A]

Decoro / Decor

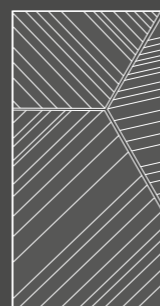

Victoria
Tasman
Awanui
Fiordland

Tech 60x120
24"x48"
Lap Ret

Kauri

LEGNO

100% DESIGN AND PRODUCTION OF ITALY

Sviluppo grafico per formato
Pattern by size
Développement graphique par format
Grafischer Entwurf für Format

20x120
8,8 mm
39

7,5x40,7
8,8 mm
50

7,5x45
8,8 mm
50

Sviluppo Grafico

Pattern by size. Développement graphique par format. Grafischer Entwurf für Format.

TASMAN 20x120



Lo sviluppo grafico mostra solo una selezione dei pattern disponibili. Il numero totale delle grafiche è indicato di seguito.
The graphic development shows only a selection of the available patterns. The total number of patterns is specified below.
Le développement graphique montre uniquement une sélection des motifs disponibles. Le nombre total de motifs est indiqué ci-dessous.
Die grafische Entwicklung zeigt nur eine Auswahl der verfügbaren Muster. Die Gesamtzahl der Muster ist unten angegeben.

PATTERNS 39

Decori

Decors

8,8 mm



Tech Victoria 60x120
24"x48"
Lap Ret



Tech Tasman 60x120
24"x48"
Lap Ret



Tech Awanui 60x120
24"x48"
Lap Ret



Tech Fiordland 60x120
24"x48"
Lap Ret

Kauri

Kauri

8,8 mm



20x120
8"x48"



7,5x40,7
3"x16"



7,5x45
3"x18"

| | Nat Ret [R10A] | Lap Ret | Nat [R10A] | Nat [R10A] |
|------------|----------------|---------|------------|------------|
| VICTORIA | 075100 | 075101 | 075310 | 075309 |
| TASMAN | 075095 | 075096 | 075304 | 075302 |
| NELSON | 075102 | 075104 | 075312 | 075311 |
| AWANUI | 075071 | 075072 | 075303 | 075301 |
| CATLINS | 075075 | 075076 | 075306 | 075305 |
| FIORDLAND | 075085 | 075086 | 075308 | 075307 |
| Price code | M113 | M129 | M107 | M091 |

8,8 mm



Tech 60x120
24"x48"

| | Lap Ret |
|------------|---------|
| VICTORIA | 075032 |
| TASMAN | 075027 |
| NELSON | - |
| AWANUI | 075003 |
| CATLINS | - |
| FIORDLAND | 075017 |
| Price code | M135 |

Pezzi Speciali / Trims. Pièces speciale. Die Sonderstücke

8,8 mm



Battiscopa
Skirting

6,5x120

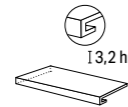

Gradino
costa retta**
Straight nosed stair**

33x120

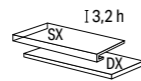

Gradino
costa retta SX - DX**
Straight-edge step L-R

33x120

| | Nat Ret [R10A] | Lap Ret | Nat Ret [R10A] | Nat Ret [R10A] |
|------------|----------------|---------|----------------|------------------------|
| VICTORIA | 075162 | 075163 | 075210 | 075212 SX 075214 DX |
| TASMAN | 075160 | 075161 | 075204 | 075206 SX 075208 DX |
| NELSON | 075164 | 075166 | 075226 | 075227 SX 075228 DX |
| AWANUI | 075150 | 075151 | 075180 | 075182 SX 075184 DX |
| CATLINS | 075152 | 075153 | 075186 | 075188 SX 075190 DX |
| FIORDLAND | 075156 | 075157 | 075192 | 075194 SX 075196 DX |
| Price code | P040 | P043 | P207 | P231 |

Calpestio . Foot traffic

• VICTORIA, TASMAN LOW • FIORDLAND MEDIUM • NELSON, AWANUI, CATLINS HIGH



Floor
Nelson 20x120_8"x48" Lap Ret

Imballi / Packings. Emballage. Verpackung

| | PCS/BOX | MQ/BOX | KG/BOX | BOX/PAL | MQ/PAL | KG/PAL | PACKING | PACKING SIZE |
|-----------------------|-------------|--------|--------|---------|--------|--------|---------|----------------|
| 8,8 mm | | | | | | | | |
| 20 x 120 LAP RET | 6 | 1,44 | 27,9 | 24 | 34,56 | 670 | EPAL | 80 x 120 x 55h |
| 20 x 120 NAT RET | 4 | 0,96 | 18,6 | 60 | 57,60 | 1.116 | EPAL | 80 x 120 x 55h |
| DECORI. DECORS | | | | | | | | |
| TECH 60 x 120 | 2 | 1,44 | 27,9 | 30 | 43,20 | 837 | EPAL | 80 x 120 x 75h |
| CHEVRON 7,5 x 40,7 | 14DX - 14SX | 0,88 | 15,7 | 42 | 36,96 | 660 | EPAL | 80 x 120 x 75h |
| LISTELLO 7,5 x 45 | 28 | 0,95 | 18,2 | 42 | 39,9 | 764 | EPAL | 80 x 120 x 75h |



| PEZZI SPECIALI. TRIMS | PCS/BOX | MQ/BOX | KG/BOX | PACKING | PACKING SIZE |
|--|---------|--------|--------|---------|--------------|
| 8,8 mm | | | | | |
| BATTISCOPIA 6,5 x 120 | 6 | - | 11 | EPAL | 80 x 120 |
| GRADINO COSTA RETTA 33 x 120 x 3,2h ** | 2 | - | 23 | EPAL | 80 x 120 |
| GRADINO COSTA RETTA 33 x 120 x 3,2h SX/DX ** | 1 | - | 12 | EPAL | 80 x 120 |

** A disposizione solo su richiesta. Tempi di consegna: 30gg
Available upon request only. Delivery terms: 30 days
Disponible seulement sur requête. Délais de livraison: 30 jours
Verfügbar auf Anfrage. Lieferzeit: 30 Tage

Design

Scratch

465

Imagine

473

Scratch DESIGN

FUKSAS

Designers: Doriana and Massimiliano Fuksas



MOONLIGHT DARK GRAFFITI LIGHT GRAFFITI ECLIPSE MILKY WAY SUPERLUNA



Gres Porcellanato. Porcelain tiles
Grès cérame. Feinsteinzeug
ISO 13006 - G - Bla_E ≤ 0,5%
UNI EN 14411

ANSI A - 326.3: 2021
W E T D Y N A M I C
COEFFICIENT OF FRICTION

DCOF ≥ 0,42

6 mm

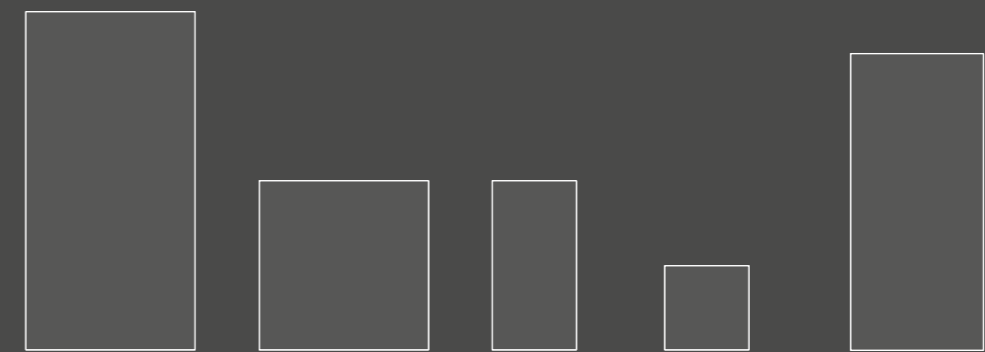

160x320
63"x126"
Nat Ret

160x160
63"x63"
Nat Ret

80x160
31 1/2"x63"
Nat Ret

80x80
31 1/2"x31 1/2"
Nat Ret

120x280
48"x110"
Nat Ret

modular system

Decoro / Decor

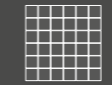

Mosaico 30x30
12"x12"
Nat Ret

8,8 mm



60x120
24"x48"
Nat Ret

Scratch **FUKSAS DESIGN**
DESIGN

100% DESIGN AND PRODUCTION OF ITALY

| | | | | | | |
|---|------------------------|------------------------|-----------------------|----------------------|------------------------|-------------------------|
| Sviluppo grafico per formato Pattern by size Développement graphique par format Grafischer Entwurf für Format | 160x320 6 mm | 160x160 6 mm | 80x160 6 mm | 80x80 6 mm | 120x280 6 mm | 60x120 8,8 mm |
| | 7 | 14 | 28 | 56 | 11 | 9 |

Sviluppo Grafico

Pattern by size. Développement graphique par format. Grafischer Entwurf für Format.

LIGHT GRAFFITI 160x320 6 mm



7 PATTERNS



Wall
Light Graffiti 160x320_63'x126" Nat Ret

6 mm

| | 160x320 63"x126" | 160x160 63"x63" | 80x160 31 1/2"x63" | 80x80 31 1/2"x31 1/2" | 120x280 48"x110" | Mosaico 30x30 12"x12" |
|----------------|---------------------|--------------------|-----------------------|--------------------------|---------------------|--------------------------|
| | Nat Ret | Nat Ret | Nat Ret | Nat Ret | Nat Ret | Nat Ret |
| MOONLIGHT | 149004 | 149044 | 149084 | 149104 | 149024 | 149433 |
| DARK GRAFFITI | 149006 | 149046 | 149086 | 149106 | 149026 | 149435 |
| LIGHT GRAFFITI | 149005 | 149045 | 149085 | 149105 | 149025 | 149434 |
| ECLIPSE | 149002 | 149042 | 149082 | 149102 | 149022 | 149431 |
| MILKY WAY | 149001 | 149041 | 149081 | 149101 | 149021 | 149430 |
| SUPERLUNA | 149003 | 149043 | 149083 | 149103 | 149023 | 149432 |
| Price code | M181 | M169 | M155 | M133 | M163 | M193 |

Pezzi Speciali / Trims. Pièces speciale. Die Sonderstücke

8,8 mm

| | 60x120 24"x48" | Battiscopa Skirting 6,5x120 Nat Ret | Gradino costa retta** Straight-edge stair** 33x120 Nat Ret | Gradino costa retta SX - DX** Straight-edge step L-R corner** 33x120 Nat Ret |
|----------------|-------------------|---|---|---|
| MOONLIGHT | 149124 | 149204 | 149313 | 149333 SX 149323 DX |
| DARK GRAFFITI | 149126 | 149206 | 149315 | 149335 SX 149325 DX |
| LIGHT GRAFFITI | 149125 | 149205 | 149314 | 149334 SX 149324 DX |
| ECLIPSE | 149122 | 149202 | 149311 | 149331 SX 149321 DX |
| MILKY WAY | 149121 | 149201 | 149310 | 149330 SX 149320 DX |
| SUPERLUNA | 149123 | 149203 | 149312 | 149332 SX 149322 DX |
| Price code | M121 | P040 | P207 | P231 |

Pezzi Speciali / Trims. Pièces speciale. Die Sonderstücke

6 mm

| | Battiscopa Skirting 8x80 Nat Ret | Gradino costa retta** Straight-edge stair** 33x160 Nat Ret | Gradino costa retta SX - DX** Straight-edge step L-R corner** 33x160 Nat Ret |
|----------------|--|---|---|
| MOONLIGHT | 149213 | 149253 | 149273 SX 149263 DX |
| DARK GRAFFITI | 149214 | 149254 | 149275 SX 149265 DX |
| LIGHT GRAFFITI | 149215 | 149255 | 149274 SX 149264 DX |
| ECLIPSE | 149211 | 149251 | 149271 SX 149261 DX |
| MILKY WAY | 149210 | 149250 | 149270 SX 149260 DX |
| SUPERLUNA | 149212 | 149252 | 149272 SX 149262 DX |
| Price code | P029 | P303 | P319 |

Calpestio . Foot traffic

• MOONLIGHT, DARK GRAFFITI, SUPERLUNA LOW • ECLIPSE MEDIUM • LIGHT GRAFFITI, MILKY WAY HIGH

Imballi / Packings. Emballage. Verpackung

| | PCS/BOX | MQ/BOX | KG/BOX | PCS/PAL | BOX/PAL | MQ/PAL | KG/PAL | PACKING | PACKING SIZE | TARE (KG) |
|-----------------|---------|--------|--------|---------|---------|--------|--------|------------------|-------------------|-----------|
| 6 mm | | | | | | | | | | |
| 160 x 320 | - | - | - | 14 | - | 71,68 | 1.039 | CASSA | 345 x 175 x 37h | 140 |
| 160 x 160 | - | - | - | 44 | - | 225,28 | 3.262 | CAVALLETTO LEGNO | 330 x 75 x 193,5h | 177,50 |
| 80 x 160 | 2 | 2,56 | 37,1 | - | 15 | 38,40 | 557 | PALLET SPECIALE | 168 x 97 x 40,9h | 29,4 |
| 80 x 80 | 3 | 1,92 | 28,2 | - | 40 | 76,80 | 1.130 | EPAL | 80 x 120 | 22 |
| 120 x 280 | - | - | - | 20 | - | 67,20 | 1.081 | CASSA | 292 x 145 x 35h | 108 |
| MOSAICO 30 x 30 | 9 | 0,81 | 12 | - | 60 | 48,60 | 720 | CAVALLETTO LEGNO | 290 x 75 x 161h | 145 |
| 8,8 mm | | | | | | | | | | |
| 60 x 120 | 2 | 1,44 | 28 | - | 32 | 46,08 | 896 | EPAL | 80 x 120 | 22 |



Cavalletto in legno
Wood A-Frame. Support en bois.
Holzgestell



Cassa
Crate. Caisse. Kiste



Pallet speciale con sponde
Special pallet with sides.
Palette spéciale avec bords.
Spezial-Palette mit Wandungen.



Epal / Pallet

| PEZZI SPECIALI. TRIMS. | PCS/BOX | MQ/BOX | KG/BOX | PACKING | PACKING SIZE |
|---|---------|--------|--------|-----------------|------------------|
| 6 mm | | | | | |
| BATTISCOPA 8 x 80 | 12 | 0,77 | 11,50 | PALLET | 80 x 120 |
| GRADINO COSTA RETTA 33 x 160 x 3,2h ** | 1 | - | 9 | PALLET SPECIALE | 168 x 97 x 40,9h |
| GRADINO COSTA RETTA 33 x 160 x 3,2h SX/DX** | 1 | - | 10 | PALLET SPECIALE | 168 x 97 x 40,9h |
| 8,8 mm | | | | | |
| BATTISCOPA 6,5 x 120 | 6 | - | 11,40 | PALLET | 80 x 120 |
| GRADINO COSTA RETTA 33 x 120 x 3,2h ** | 2 | - | 22 | PALLET | 80 x 120 |
| GRADINO COSTA RETTA 33 x 120 x 3,2h SX/DX** | 1 | - | 11 | PALLET | 80 x 120 |

**** A disposizione solo su richiesta. Tempi di consegna: 30gg**
Available upon request only. Delivery terms: 30 days
Disponible seulement sur requête. Délais de livraison: 30 jours
Verfügbar auf Anfrage. Lieferzeit: 30 Tage

Imagine

DESIGN





KENZIA

BOTANICAL

PLUMAGE

NAIF

PARADISE

JUNGLE
CHIC

SHADOW
LEAVES

AUTUMN

ARECA



Da rivestimento.
Wall tile. Pour revêtement. Für Wandbelag.

Gres Porcellanato. Porcelain tiles
Grès cérame. Feinsteinzeug
ISO 13006 - G - Bla_E ≤ 0,5%
UNI EN 14411

6 mm



120x280
48"x110"
Nat Ret

8,8 mm



60x120
24"x48"
Nat Ret

Imagine

100% DESIGN AND PRODUCTION OF ITALY

Imagine

KENZIA
120x280



6 mm



120x280
48"x110"
174003 Nat Ret

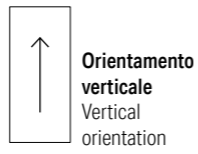
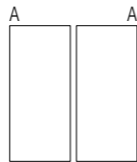

1 PATTERN

60x120



8,8 mm



60x120
24"x48"
174023 Nat Ret

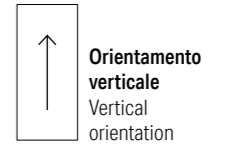
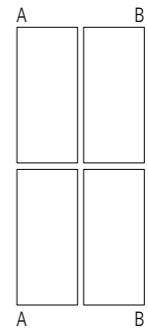

2 PATTERNS



Wall
Kenzia 120x280_48"x110" Nat Ret

Floor
Statuario Reale 120x280_48"x110" Lap Ret

Imagine

BOTANICAL
120x280



6 mm



120x280
48"x110"
174002 Nat Ret

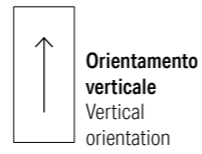
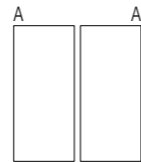

1 PATTERN

60x120



8,8 mm



60x120
24"x48"
174022 Nat Ret

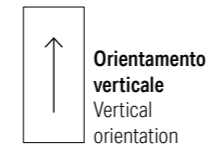
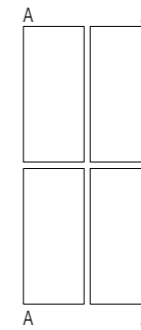

1 PATTERN



Wall
Botanical 60x120_24"x48" Nat Ret
Bronze Amani 120x280_48"x110" Lap Ret

Imagine

PLUMAGE
120x280



6 mm



120x280
48"x110"
174004 Nat Ret

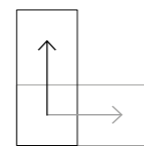
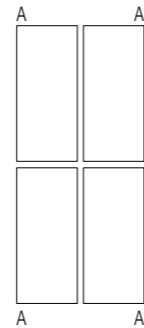

Orientamento
orizzontale e verticale
Vertical and orizontal
orientation

1 PATTERN

60x120



8,8 mm



60x120
24"x48"
174024 Nat Ret

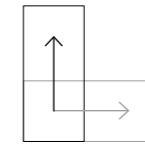
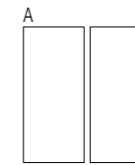

Orientamento
orizzontale e verticale
Vertical and orizontal
orientation

1 PATTERN



Wall
Plumage 120x280_48"x110" Nat Ret

Imagine

NAIF
120x280



120x280
48"x110"
174009 Nat Ret

120x280
48"x110"
174010 Nat Ret

2 PATTERNS

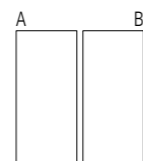

↑
Orientamento
verticale
Vertical
orientation

60x120



8,8 mm



60x120
24"x48"
174027 Nat Ret

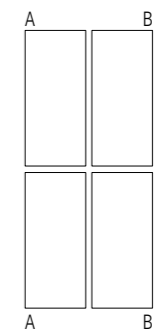

↑
Orientamento
verticale
Vertical
orientation

2 PATTERNS



Wall
Naif 120x280_48"x110" Nat Ret

Floor
Il Cerreto Dec. Champagne Grey 30x26_12"x10½" Nat Ret

Imagine

PARADISE
120x280



6 mm

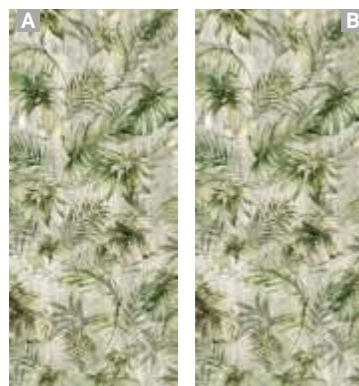

120x280
48"x110"
174007 Nat Ret

120x280
48"x110"
174008 Nat Ret

2 PATTERNS

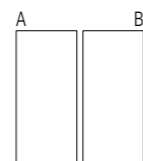

↑
Orientamento
verticale
Vertical
orientation

60x120



8,8 mm



60x120
24"x48"
174026 Nat Ret

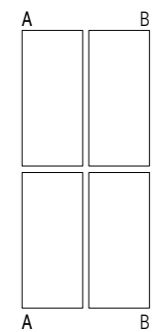

↑
Orientamento
verticale
Vertical
orientation

2 PATTERNS



Wall
Paradise 120x280_48"x110" Nat Ret

Imagine

JUNGLE CHIC
120x280



6 mm



120x280
48"x110"
174005 Nat Ret

120x280
48"x110"
174006 Nat Ret

2 PATTERNS

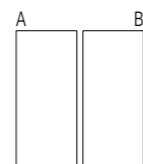

↑
Orientamento
verticale
Vertical
orientation

60x120



8,8 mm



120x60
48"x24"
174025 Nat Ret

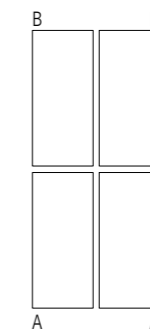

↑
Orientamento
verticale
Vertical
orientation

2 PATTERNS



Wall
Jungle Chic 120x280_48"x110" Nat Ret

Floor
Il Cerreto Pinot Grigio 20x120_8"x48" - 30x120_12"x48" Nat Ret

Imagine

SHADOW LEAVES 120x280



6 mm

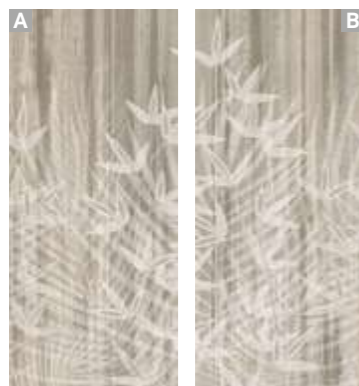

120x280
48"x110"
174011 Nat Ret

120x280
48"x110"
174012 Nat Ret

2 PATTERNS

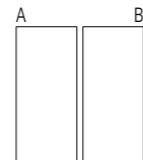

↑
**Orientamento
verticale**
Vertical
orientation

60x120



8,8 mm



60x120
24"x48"
174028 Nat Ret

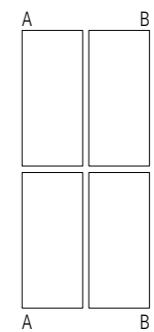

↑
**Orientamento
verticale**
Vertical
orientation

2 PATTERNS



Wall
Shadow Leaves 120x280_48"x110" Nat Ret

Floor
Imperial Trevi 120x120_48"x48" Nat Ret

Imagine

AUTUMN
120x280



6 mm

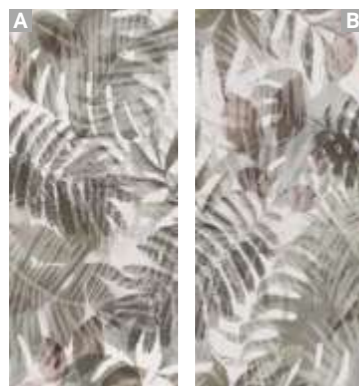

120x280
48"x110"
174013 Nat Ret

120x280
48"x110"
174014 Nat Ret

2 PATTERNS

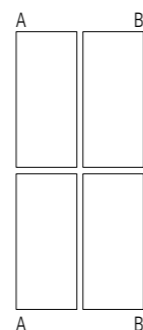

↑
Orientamento
verticale
Vertical
orientation

60x120



8,8 mm



60x120
24"x48"
174029 Nat Ret

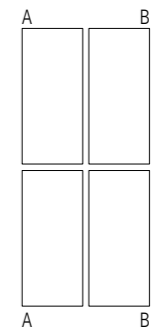

↑
Orientamento
verticale
Vertical
orientation

2 PATTERNS



Wall
Autumn 120x280_48"x110" Nat Ret

Floor
Calacatta Oro 120x280_48"x110" Lap Ret

Imagine

ARECA
120x280



6 mm



120x280
48"x110"
174001 Nat Ret

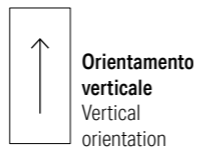
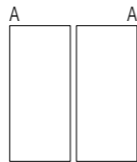

1 PATTERN

60x120



8,8 mm



60x120
24"x48"
174021 Nat Ret

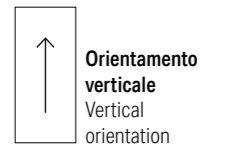
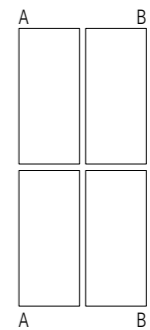

2 PATTERNS



Wall
Areca 120x280_48"x110" - 60x120_24"x48" Nat Ret



Imagine

DESIGN

Da rivestimento. Wall tile
Pour revêtement. Für Wandbelag

6 mm



120x280
48"x110"

Nat Ret

| | | Nat Ret | |
|-------------------|--|----------------------|----------------------|
| KENZIA | | 174003 | - |
| BOTANICAL | | 174002 | - |
| PLUMAGE | | 174004 | - |
| NAIF | | 174009 A 174010 B | - |
| PARADISE | | - | 174007 A 174008 B |
| JUNGLE CHIC | | - | 174005 A 174006 B |
| SHADOW LEAVES | | 174011 A 174012 B | - |
| AUTUMN | | 174013 A 174014 B | - |
| ARECA | | - | 174001 |
| Price code | | M472 | M452 |

8,8 mm



60x120
24"x48"

Nat Ret

| | | Nat Ret | |
|-------------------|--|--------------|-------------|
| KENZIA | | 174023* | |
| BOTANICAL | | - | 174022 |
| PLUMAGE | | - | 174024 |
| NAIF | | 174027* | |
| PARADISE | | 174026* | |
| JUNGLE CHIC | | 174025* | |
| SHADOW LEAVES | | 174028* | |
| AUTUMN | | 174029* | |
| ARECA | | 174021* | |
| Price code | | CP375 | P270 |

***Articolo venduto a composizione**

Item sold by composition. Article vendu par composition. Der artikel wird als komposition verkauft.

Imballi / Packings. Emballage. Verpackung

| | PCS/BOX | MQ/BOX | KG/BOX | PCS/PAL | BOX/PAL | MQ/PAL | KG/PAL | PACKING | PACKING SIZE | TARE (KG) |
|---------------|---------|--------|--------|---------|---------|--------|--------|------------------|-----------------|-----------|
| 6 mm | | | | | | | | | | |
| 120 x 280 | - | - | - | 20 | - | 67,20 | 1.081 | CASSA | 292 x 145 x 35h | 108 |
| | - | - | - | 44 | - | 147,84 | 2.285 | CAVALLETTO LEGNO | 290 x 75 x 161h | 145 |
| 8,8 mm | | | | | | | | | | |
| 60 x 120 | 2 | 1,44 | 31,68 | - | 20 | 28,80 | 656 | EPAL | 80 x 120 | 22 |



Cavalletto in legno
Wood A-Frame .
Support en bois .
Holzgestell



Cassa
Crate . Caisse . Kiste



Epal

Imagine

Descrizione

Note generali

General notes. Notes générales. Allgemeinen Bemerkungen

General notes. Notes générales. Allgemeinen Bemerkungen

General notes. Notes générales. Allgemeinen Bemerkungen

INDICAZIONI GENERALI

Le lastre della collezione IMAGINE sono destinate esclusivamente al rivestimento di pareti di ambienti interni. È necessario prestare dunque la massima attenzione durante la movimentazione delle lastre evitando di urtare o strisciare utensili ed oggetti duri e appuntiti sulla loro superficie. Nella fase di sollevamento, tenere separate le lastre con il foglio protettivo per evitare di sfregare le superfici fra di loro.

DECORI CON VETRO E GRANIGLIE

Materiale di pregiata fattura ceramica con caratteristica presenza di craquelé. Le decorazioni mediante l'applicazione artigianale dei vetri e delle graniglie vetrose sulle piastrelle ceramiche possono presentare delle irregolarità nella loro distribuzione in superficie. Questo non pregiudica l'effetto estetico del prodotto ma anzi ne esalta le caratteristiche.

DECORI CON ORO E LUSTRO

Decorì con oro-platino-lustro-metallizzato e graniglia Shine. La graniglia Shine conferisce una brillantezza zuccherina a basso spessore. I decori realizzati con smalti, contenenti percentuali di oro puro, con il tempo possono perdere la loro brillantezza assumendo una colorazione tipica dell'oro antico. L'applicazione di pregiati lustri metallizzati donano alla piastrella diversi toni di colore conferendo al prodotto accentuati riflessi madreperlacei ed una maggiore incisività nei colori.

ISTRUZIONI PER LA POSA

Prima di iniziare l'operazione di posa accertarsi che la lastra sia posizionata sul lato corretto e che il disegno sia allineato alla grafica delle lastre adiacenti. Spalmare la colla sulle pareti da rivestire utilizzando una spatola dentata di almeno 6mm. Dal momento che si trattano di rivestimenti di pareti interne, non è necessaria l'applicazione della colla sul retro della lastra. Sono idonei alla posa gli adesivi di classe C251. Per un miglior risultato estetico, si consiglia di distanziare le lastre con una fuga da 1mm. Utilizzare, invece, una spatola gommata per battere le lastre al fine di allinearle fra di loro.

Non impiegare stucchi epossidici ma sigillare le fughe solo con stucchi cementizi, proteggendo preventivamente la superficie della piastrella con scotch di carta. Non usare sistemi meccanici livellanti poiché la loro rimozione potrebbe danneggiare la superficie del decoro.

ISTRUZIONI PER PULIZIA

Non utilizzare spugne abrasive ma ripulire immediatamente, con delicatezza, eventuali residui di stucco con un panno utilizzando acqua o detergenti neutri comuni in commercio. Per lo sporco ostinato utilizzare un qualunque detergente sgrassante purché non sia di alto livello alcalino. Non impiegare nel modo più assoluto alcool, acetone, solventi, candeggina, ammoniaca e prodotti alcalini, acidi di forte intensità o materiali abrasivi.

Non attenendosi a queste norme, Italcer S.p.A SB non risponde di eventuali danni arrecati al prodotto in fase di contestazione.

GENERAL INDICATIONS

Slabs from the IMAGINE collection are intended exclusively for indoor wall tiling. The decorations of this product are poorly scratch resistant. Therefore, care must be taken when handling the slabs to avoid impacting or dragging tools and hard, sharp objects on their surface. While lifting, keep the slabs separated with the protective sheet to avoid rubbing the surfaces together.

DECORATIONS WITH GLASS AND GRITS

High-quality handicraft ceramic material, featured by the crazing effect. Decorations by the artisanal application of glass and vitreous grit on ceramic tiles may feature irregularities in their surface distribution. This does not affect the aspect of the product, rather enhances its characteristics.

DECORATIONS WITH GOLD AND LUSTRE

Decorations with gold-platinum-lustre-metallic and Shine grit. Shine grit gives a low-thickness shiny white gloss. Decorations made with glazes featured by small percentage of pure gold can lose brilliancy in time, getting the peculiar colour of old gold. The application of precious metallic lustres gives the tile different colour shades, for a product with bright mother-of-pearl reflections and greater colour incisiveness.

INSTALLATION INSTRUCTIONS

Before starting installation, make sure that the slab is positioned on the correct side and that the pattern is aligned with the graphics of the adjacent slabs. Spread the adhesive on the walls to be tiled using a notched trowel of at least 6 mm. As an interior wall coating, no slab back buttering is needed. Class C251 adhesives are suitable for installation.

For a better aesthetic result, we recommend spacing the slabs with a 1-mm joint. Instead, use a rubber trowel to beat the slabs to align them reciprocally. Do not use epoxy grouts, rather seal joints with cementitious grouts only, protecting the tile surface beforehand with a paper masking tape. Do not use mechanical levelling systems as their removal may damage the surface of the decoration.

CLEANING INSTRUCTIONS

Do not use abrasive sponges, rather immediately and gently wipe away any grout residue with a cloth using water or commercially available neutral detergents. For stubborn dirt, use any degreasing detergent as long as it is not highly alkaline. Never use alcohol, acetone, solvents, bleach, ammonia and alkaline products, strong acids or abrasive materials.

Should these rules not be followed, Italcer S.p.A SB is not liable for any damage caused to the product claimed.

INDICATIONS GÉNÉRALES

Les dalles des collections IMAGINE sont exclusivement destinées au revêtement mural d'espaces intérieurs. Les décorations de ce produit n'offrent pas une bonne résistance aux rayures. Il est donc nécessaire de faire très attention lors de la manipulation des dalles en évitant de les heurter ou de traîner des ustensiles et des objets durs et pointus sur leur surface. Au moment du levage, séparer les dalles avec la feuille de protection afin d'éviter de froter les surfaces entre elles.

DÉCORATIONS AVEC DU VERRE ET DE LA GRENAILLE

Matériau céramique haut de gamme caractérisé par la présence de craquelures.Les décorations par application artisanale sur le carrelage de verre et de grenaille en verre peuvent présenter des irrégularités de répartition sur la surface. Cela ne réduit pas l'effet esthétique du produit et, au contraire, met en valeur ses caractéristiques.

DÉCORATIONS DORÉES ET LUSTRÉES

Décorations avec or-platine-lustre-métallisées et grenaille Shine. La grenaille Shine apporte une brillance liqueuse dans une faible épaisseur. Les décorations réalisées avec des émaux, qui contiennent un certain pourcentage d'or pur, peuvent se ternir au fil du temps et prendre une coloration typique d'or patiné. L'application de lustres métallisés de très grande qualité donne au carrelage plusieurs teintes qui confèrent au produit des reflets nacrés accentués et des couleurs plus prononcées.

INSTRUCTIONS POUR LA POSE

Avant de commencer la pose, s'assurer que la dalle soit positionnée du bon côté et que le dessin soit aligné avec le dessin des dalles adjacentes. Étaler la colle sur les murs en utilisant une spatule dentée d'au moins 6 mm. S'agissant de murs d'espaces intérieurs, il n'est pas nécessaire d'appliquer la colle au dos de la dalle. Les colles de classe C251 conviennent pour la pose. Pour un meilleur résultat esthétique, il est conseillé de laisser un joint de 1 mm entre les dalles.En revanche, utiliser une spatule en caoutchouc pour taper délicatement sur les dalles afin de les aligner. Ne pas utiliser de mortiers époxy mais réaliser les joints avec des mortiers pour joints à base de ciment. Ne pas utiliser de systèmes de nivellement mécaniques car leur retrait pourrait endommager la surface de la décoration.

INSTRUCTIONS POUR LE NETTOYAGE

Ne pas utiliser d'éponges abrasives mais retirer immédiatement, et délicatement, les éventuels résidus de mortier avec un chiffon et de l'eau ou des détergents neutres disponibles dans le commerce. Pour les taches tenaces, utiliser un détergent dégraissant d'usage courant à condition qu'il soit hautement alcalin. Ne jamais utiliser d'alcool, d'acétone, de solvants, d'eau de Javel, d'ammoniac ni de produits alcalins, d'acides puissants ni de matériaux abrasifs.

En cas de non-respect de ces règles, Italcer S.p.A SB ne peut être tenue pour responsable des éventuels dommages sur les produits en cas de contestation.

ALLGEMEINES

Die Platten der Kollektionen IMAGINE sind ausschließlich als Wandbelag im Innenbereich bestimmt. Die Dekors dieses Produkts sind nicht besonders kratzfest. Daher muss bei der Handhabung der Platten darauf geachtet werden, dass Werkzeuge und harte, scharfe Gegenstände nicht an der Oberfläche anstoßen oder schaben. Halten Sie die Platten beim Anheben mit der Schutzfolie getrennt, um ein Aneinanderreiben der Oberflächen zu vermeiden.

DEKORE MIT GLAS- UND FESTEILCHEN

Hochwertiges Keramikmaterial mit besonderer Craquelé-Optik. Dekorationen durch das handwerkliche Aufbringen von Glas und Glassplitt auf Keramikfliesen können Unregelmäßigkeiten in ihrer Oberflächenverteilung aufweisen. Es handelt sich dabei keinesfalls um eine Beeinträchtigung der ästhetischen Wirkung des Produkts, sondern vielmehr um eine Besonderheit.

DEKORE MIT GOLD UND GLITTER

Dekore mit Gold-, Platin-, Glitter-, Metallic- und Shine-Einschlüssen. Die körnigen Shine-Einschlüsse verleihen der Produkt eine samtige Brillanz mit geringer Stärke. Glasurdekore, die einen Anteil an reinem Gold enthalten, können mit der Zeit ihren Glanz verlieren und eine antike Goldfarbe annehmen. Die Applikation von kostbarem Metallic-Glittermaterial verleiht der Fliese verschiedene Farbtöne mit mutterperligem Schimmer und einer Verstärkung der Farben.

VERLEGEHINWEISE

Bevor man mit der Verlegung beginnt immer sicherstellen, dass die Platte auf der richtigen Seite liegt und dass das Muster mit den Grafiken der angrenzenden Platten übereinstimmt. Den Klebstoff mit einer mindestens 6 mm Zahnpachtel auf den zu verlegenden Wänden auftragen.

Da es sich um Wandbeläge im Innenbereich handelt, muss kein Kleber auf die Rückseite der Platte aufgetragen werden. Für die Verlegung eignen sich die Klebstoffe der Klasse C251. Für die optisch ansprechendste Verlegung dieser Platte wird eine Fugenbreite von 1 mm empfohlen. Für die richtige Ausrichtung der Platten, diese mit einer Gummispatel abklopfen. Keine Epoxid-, sondern Zementfugenmasse benutzen. Keine mechanischen Nivelliersysteme verwenden, da bei deren Entfernung die Oberfläche des Dekors beschädigt werden könnte.

REINIGUNGSHINWEISE

Keine Scheuerschwämme benutzen, sondern Fugenmassenrückstände sofort mit einem Tuch und Wasser oder handelsüblichen Neutralreinigern vorsichtig entfernen. Für hartnäckige Verschmutzungen eignen sich herkömmliche fettlösende Reinigungsmittel, unter der Bedingung, dass sie nicht stark alkalisch sind. Niemals Alkohol, Aceton, Lösungsmittel, Bleichmittel, Ammoniak und alkalische Produkte, starke Säuren oder Scheuermittel verwenden

Bei Nichteinhaltung dieser Regeln haftet Italcer S.p.A SB nicht für beanstandete Produktschäden.

Technical section

ADVANCE®

La ceramica che combatte
il coronavirus e i batteri

The tiles fighting
coronavirus and bacteria 500

TANTE FACCE TUTTE DIFFERENTI

Endless looks, all different 508

LA STUOIA

Fiber glass mesh 509

CHEVRON XL & CHEVRON 511

SCHEMI DI POSA

Laying sketch 516

SISTEMI DI POSA 20MM

Installation systems - 20MM 519

LA POSA SOPRAELEVATA

Raised laying 520

LA POSA A SECCO SU ERBA

Dry laying on grass 532

LA POSA A SECCO SU GHIAIA

Dry laying on gravel 533

LA POSA A SECCO SU SABBIA

Dry laying on sand 534

LA POSA A COLLA SU MASSETTO

Adhesive application on screed 535

I PEZZI SPECIALI 20MM

Trims 20MM 537

IMBALLI

Package 542

CARATTERISTICHE TECNICHE

Technical features 544

CERTIFICAZIONI

Certification 547

CORRETTA PULIZIA E MANUTENZIONE DEL PRODOTTO

Important product
cleaning and maintenance 550

CONDIZIONI GENERALI DI VENDITA

General sales terms
and conditions 552

NOTE GENERICHE SUI PRODOTTI

General information
on the products 556



ADVANCE[®]
 ANTIBACTERIAL & BIO-AIR PURIFYING

La ceramica che combatte il coronavirus e i batteri*

ADVANCE[®] è una ceramica da pavimento e rivestimento eco-compatibile in gres porcellanato, realizzata in primo ed unico fuoco, ad oltre 1200 gradi di cottura e con il 40% di materie prime riciclate, adatta sia per soluzioni residenziali che non residenziali. L'innovativa tecnologia ADVANCE[®] grazie alle sue **proprietà antivirali, antibatteriche e fotocatalitiche** è capace di proteggere maggiormente gli ambienti che ci circondano rendendoli più salubri e riducendo significativamente l'inquinamento.

**Dopo 6 ore di esposizione alla luce, ADVANCE[®] è in grado di eliminare il 100% dei coronavirus e già dopo 15 min. il 90%.*

Dopo 8 ore di esposizione alla luce, combatte le diverse tipologie di batteri da un minimo del 95% fino al 100%.

I risultati dei test di laboratorio effettuati su ADVANCE[®] sono disponibili sul sito www.advanceceramic.it

EN_ The tiles fighting coronavirus and bacteria*

ADVANCE[®] porcelain floor and wall tiles can be used for residential and non-residential solutions. They are made of eco-friendly and single-fired (over 1,200 degrees) porcelain stoneware and of 40% recycled raw materials. Thanks to its **antiviral, antibacterial and photocatalytic properties**, the innovative ADVANCE[®] technology is able to improve protection in the environment around us, making it healthier and reducing significantly pollution.

**After 6 hours of light exposure, ADVANCE[®] is able to eliminate 100% of coronaviruses and just after 15 minutes it will eliminate 90% of them. After 8 hours of light exposure, it fights against different types of bacteria, from a minimum of 95% up to 100%. The results of the laboratory tests carried out on ADVANCE[®] are available on our website www.advanceceramic.it/en.*

FR_ Le carrelage qui combat le coronavirus et le bactéries*

ADVANCE[®] est une céramique pour sol et mur en grès cérame respectueuse de l'environnement, réalisée en première et unique cuisson cuit à plus de 1200 degrés et composée à 40 % de matières premières recyclées. Elle s'adapte aussi bien aux espaces résidentiels qu'aux autres espaces. Ses **propriétés antivirales, antibactériennes et photocatalytiques** permettent à la technologie innovante ADVANCE[®] de mieux protéger les espaces qui nous entourent en les assainissant et en réduisant la pollution de manière significative.

**Après 6 heures d'exposition à la lumière, ADVANCE[®] supprime 100% des coronavirus, et après 15 minutes seulement l'efficacité est déjà de 90%. Après 8 heures d'exposition à la lumière, il élimine différents types de bactéries, avec des résultats à minima de 95% et jusqu'à 100%. Les résultats des test de laboratoire menés sur ADVANCE[®] sont disponibles sur notre site www.advanceceramic.it/fr*

DE_ Die Keramik, die den Coronavirus und Bakterien bekämpft*

ADVANCE[®] steht für umweltfreundliche Bodenbeläge und Wandverkleidungen aus Feinsteinzeug. Dieses Feinsteinzeug wird im Einbrandverfahren bei einer Brenntemperatur von über 1200 Grad hergestellt. ADVANCE[®] besteht für 40% aus recycelten Materialien undes ist sowohl für den Wohnbereich als auch für gewerbliche Anwendungen geeignet. Die innovative Technologie von ADVANCE[®] ist dank ihrer **antiviralen, antibakteriellen und photocatalytischen Eigenschaften** in der Lage, unsere Umgebung gesünder zu machen und die Schadstoffbelastung erheblich zu reduzieren.

**Unter Belichtung kann ADVANCE[®] bereits nach 15 Minuten 90% der Coronaviren beseitigen und schon nach sechsständiger Belichtung 100%. Nach einer achtstündigen Belichtung bekämpft ADVANCE[®] die unterschiedlichen Typen von Bakterien um mindestens 95% bis zu 100%. Die mit ADVANCE[®] geführten Labortests sind auf der Internetseite www.advanceceramic.it/de einsehbar.*

Antiviral
Antibacterial
Antipollution

Futuro, Natura, Scienza

L'impegno e l'attenzione verso l'ambiente e il sociale del gruppo Italcera hanno portato alla nascita di ADVANCE®: un nuovo progetto che rappresenta la volontà di proiettarsi verso il futuro tramite una ceramica innovativa, realizzata in primo fuoco, con proprietà antivirali, antibatteriche e fotocatalitiche, capaci di salvaguardare la salute e ridurre l'inquinamento.

La nostra prima fonte di ispirazione è il FUTURO, poiché abbiamo il sogno di un mondo in cui le nuove generazioni possano utilizzare materiali sempre più sostenibili, che aiutino il benessere del pianeta, riducendo la possibilità di contaminazioni da microrganismi e l'utilizzo di detergenti chimici dannosi per l'ambiente. Utilizziamo principalmente SnO2 (biossido di stagno) e TiO2 (biossido di titanio) biomimetici, ossia ottenuti tramite processi in cui vengono replicati i meccanismi della NATURA. La sintesi avviene in primo fuoco, attraverso un'innovativa tecnica produttiva, frutto di una rivoluzionaria ricerca nel campo della SCIENZA dei materiali.

EN *Future, Nature, Science*

ADVANCE® has been created thanks to Italcera's care and attention for the environment and the community. A new project which represents our desire to focus on the future thanks to an innovative single-fired porcelain tile, with antiviral, antibacterial and photocatalytic properties, able to safeguard health and reduce pollution.

Our first source of inspiration is the FUTURE. We dream of a world in which the new generations can use increasingly sustainable materials that help the well-being of the planet, reducing the possibility of microbial contamination and environmentally harmful chemical detergents. We mainly use SnO2 (tin oxide) and TiO2 (titanium dioxide) that are biomimetic, i.e. obtained through processes that replicate those found in NATURE. Synthesis takes place during the single firing process via an innovative production technique stemming from a revolutionary research study in the field of materials SCIENCE.

FR *Future, Nature, Science*

L'engagement du Groupe Italcera et l'attention qu'il porte à l'environnement et au secteur social ont mené à la création d'ADVANCE®. Un nouveau projet qui représente l'envie de se tourner vers le futur au moyen d'une céramique innovante, réalisée en première cuisson, et dotée de propriétés antivirales, antibactériennes et photocatalytiques capables de préserver la santé et de réduire la pollution.

Notre première source d'inspiration est le FUTUR, car nous rêvons d'un monde où les jeunes générations pourront utiliser des matériaux toujours plus durables et respectueux de la planète, réduisant ainsi les risques de contamination par des microorganismes ainsi que l'utilisation de produits chimiques nocifs pour l'environnement. Nous utilisons principalement du SnO2 (dioxyde d'étain) et du TiO2 (dioxyde de titane) biomimétiques, c'est-à-dire obtenus à travers des procédés reproduisant les processus NATURELS. La synthèse s'effectue lors de la première cuisson grâce à une technique de production innovante, résultat d'une recherche révolutionnaire en SCIENCE des matériaux.

DE *Zukunft, Natur, Wissenschaft*

Aus dem Engagement der Italcera-Gruppe und ihrer Rücksichtnahme auf die Umwelt und den sozialen Bereich ist ADVANCE® entstanden. Dieses neue Projekt spiegelt auch ihren Willen wider, der Zukunft mit einer innovativen, im Einbrandverfahren hergestellten Keramik entgegenzugehen: Ihre antiviralen, antibakteriellen und photocatalytischen Eigenschaften sind in der Lage, die Gesundheit zu schützen und die Umweltverschmutzung zu reduzieren.

Unsere wichtigste Inspirationsquelle ist die ZUKUNFT, denn wir träumen von einer Welt, in der die kommenden Generationen immer nachhaltigere Materialien verwenden können, durch die es unserem Planeten besser geht, indem mögliche Kontaminationen durch Mikroorganismen und damit den Einsatz umweltschädlicher chemischer Reinigungsmittel reduziert werden. Wir verwenden in erster Linie SnO2 (Zinndioxid) und TiO2 (Titandioxid) in biomimetischer Form: sie werden mit Prozessen gewonnen, in denen die Mechanismen der NATUR repliziert werden. Die Synthese erfolgt bereits im ersten Brennvorgang, anhand einer innovativen Produktionstechnik, die das Ergebnis einer revolutionären Forschungsarbeit im Bereich der WISSENSCHAFT der Materialien ist.



**Future, nature, science
our inspiration**

ITALCER GROUP



Proprietà

La particolare composizione di questo gres permette di **abbattere virus e batteri** quando vengono a **contatto con la superficie ceramica**. ADVANCE® può essere utilizzata come ceramica per pavimentazioni e rivestimenti di pareti ed ha caratteristiche antimicrobiche e fotocatalitiche ottenute in primo fuoco.

Tali caratteristiche, che rendono questo gres di ultima generazione, sono incorporate nella prima fase di creazione della ceramica (cotta in primo fuoco ad oltre 1200°C) diventando così proprietà intrinseche del prodotto stesso, conferendo una protezione contro virus e batteri per tutto il ciclo di vita della piastrella, senza che venga alterato nel tempo o da agenti esterni.

Non essendo uno strato superficiale della ceramica, ma incorporato nella stessa, questa proprietà rimarrà integra nel tempo. Le proprietà antivirali e antibatteriche vengono esaltate da ogni condizione di luminosità, solare e artificiale, ma come dimostrano i Test di laboratori di primaria importanza, tali proprietà restano attive anche in assenza di luce.

** Alle condizioni di cui alla tabella e ai risultati dei test che seguono.*

EN_Properties

The special composition of this stoneware means that viruses and bacteria are destroyed if they come into contact with the tile surface.

ADVANCE® can be used to tile floors and walls and it features antimicrobial and photocatalytic properties achieved after a single firing. These specifications, that qualify this stoneware as the latest generation of porcelain tile, are incorporated during the initial creation phase (a single firing at over 1200°C), thus becoming intrinsic properties of the product, providing protection against viruses and bacteria for the entire lifetime of the tile, without alterations caused by time or external agents. Because it doesn't consist in a top layer on the surface of the porcelain tile, but it is an integral part of it, this property will continue to last through time.

The antiviral and antibacterial properties are enhanced by any solar and artificial light conditions, but as shown by tests made by laboratories of primary importance, these properties remain active even in dark conditions.

** Under the conditions specified in the table and the test results below.*

FR_Propriétés

La composition particulière de ce grès permet d'éliminer les virus et les bactéries dès que ceux-ci entrent en contact avec la surface en céramique.

ADVANCE® peut être utilisée en tant que céramique murale et de sol et présente des caractéristiques antimicrobiennes et photocatalytiques obtenues en première cuisson.

Ces caractéristiques, qui font de ce grès un matériau de dernière génération, sont intégrées lors de la première phase de création de la céramique (cuite en première cuisson à plus de 1200 degrés), devenant ainsi des propriétés intrinsèques au produit. Elles protègent contre les virus et les bactéries durant tout le cycle de vie du carreau, sans être altérées par le temps ou par des agents extérieurs.

Étant donné que cette propriété est directement intégrée dans la céramique et qu'elle n'est pas uniquement présente en couche superficielle sur cette dernière, elle demeure intacte au fil du temps.

Les propriétés antivirales et antibactériennes sont renforcées en présence de luminosité, qu'elle soit solaire ou artificielle. Néanmoins, comme le prouvent les tests de laboratoires renommés, ces propriétés restent actives même en absence de lumière.

** Sous réserve des conditions énoncées dans le tableau et des résultats des tests suivants.*

DE_Eigenschaften

Die besondere Zusammensetzung dieses Feinsteinzeugs ermöglicht es, Viren und Bakterien abzutöten, die mit der Keramikoberfläche in Kontakt kommen.

ADVANCE® kann sowohl für Bodenbeläge als auch für Wandverkleidungen aus Keramik verwendet werden, und besitzt im Einbrandverfahren erzielte, antimikrobielle und photocatalytische Eigenschaften.

Die Merkmale, die dieses Feinsteinzeug zu einem Produkt der neuesten Generation machen, werden während der ersten Herstellungsphase in die Keramik integriert (Einbrandverfahren bei über 1200°C). So werden sie zu natürlichen Produkteigenschaften, die die Fliesen während ihrer gesamten Lebensdauer gegen Viren und Bakterien schützen, ohne dass sie im Laufe der Zeit oder durch externe Faktoren beeinflusst werden. Da es sich nicht um eine Oberflächenschicht sondern um eine in die Keramik integrierte Eigenschaft handelt, bleibt diese auch langfristig unversehrt bestehen.

Die antiviralen und antibakteriellen Eigenschaften werden durch jede Art von Licht – sowohl Sonnenlicht als auch Kunstlicht – verstärkt, doch wie Tests renommierter Labors bestätigen, bleiben diese Eigenschaften auch ohne Lichteinfall aktiv.

** Bei den in der Tabelle angegebenen Bedingungen und mit den nachfolgenden Testergebnissen.*

Scopri le serie complete. Discover the full series.
Découvrez les séries complètes.
Entdecken Sie die komplette Serie.

Pierres des Châteaux Advance® p. 235
Il Cerreto Advance® p. 431



Wall
Pierres des Châteaux Advance® - Fontainebleau 60x60_24"x24" Nat Ret

Floor
Il Cerreto Advance® - Amaranze 23x149 (9"x58 1/2") Nat Ret



Floor
Pierres des Châteaux Advance® - Chenonceau 100x100_40"x40" Nat Ret

Elimina i virus

EN *Eliminates viruses*
FR *Élimine les virus*
DE *Eliminiert Viren*

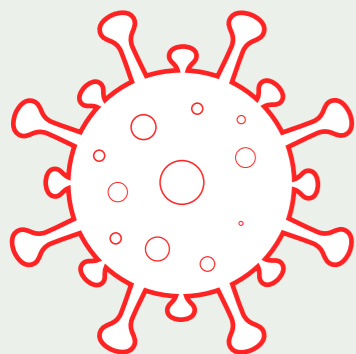

ISO 18061:2014 (E)
Coronavirus 229E
A virus H3N2*

TEST TCNA
(TILE COUNCIL OF NORTH AMERICA)

| Tempo di esposizione Exposure time Temps d'exposition Expositionsdauer | Riduzione con esposizione UV Reduction under UV exposure Réduction avec exposition aux rayons UV Reduzierung mit UV-Exposition |
|---|---|
| 15 min | 90% |
| 30 min | 90% |
| 1 h | 90% |
| 4h* | 99% |
| 6 h | 100% |
| 8 h | 100% |

| Tempo di esposizione Exposure time Temps d'exposition Expositionsdauer | Riduzione senza esposizione UV Reduction under Dark conditions Réduction sans exposition aux rayons UV Reduzierung ohne UV-Exposition |
|---|--|
| 15 min | - |
| 30 min | 90% |
| 1 h | 90% |
| 4h* | 90% |
| 6 h | 93% |
| 8 h | 99% |

Elimina i batteri

EN *Fights bacteria*
FR *Combat les bactéries*
DE *Bekämpft Bakterien*

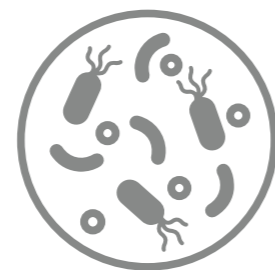

ISO 27447:2019 (E)
Escherichiacoli ATCC 8739
Stafilococco Aureo ATCC 6538

TEST DEL LABORATORIO CFR-UNIFE AND TCNA

| Tempo di esposizione Exposure time Temps d'exposition Expositionsdauer | Riduzione con esposizione UV Reduction under UV exposure Réduction avec exposition aux rayons UV Reduzierung mit UV-Exposition |
|---|---|
| 8 h | MIN. 95% - MAX 100% |

| Tempo di esposizione Exposure time Temps d'exposition Expositionsdauer | Riduzione senza esposizione UV Reduction under Dark conditions Réduction sans exposition aux rayons UV Reduzierung ohne UV-Exposition |
|---|--|
| 8 h | MIN. 93,4% - MAX 97,2% |

Riduce l'inquinamento atmosferico / 20,7% di NOx

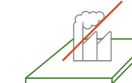

CONVERTE LE SOSTANZE INQUINANTI VOLATILI IN SOSTANZE INNOCUE. Le proprietà antinquinanti del gres ADVANCE® migliorano anche la qualità dell'aria che respiriamo. La produzione industriale, l'utilizzo di impianti di climatizzazione e dei mezzi di trasporto, emettono nell'aria sostanze inquinanti. ADVANCE® applicata in esterno, nelle pavimentazioni Outdoor, sulle facciate di abitazioni e palazzi, **riesce a diminuire le molecole di NOx** (Ossidi di Azoto) **del 20,7%** (come attestato dall'Università di Torino) in sole tre ore, permettendo di migliorare notevolmente la qualità dell'aria grazie all'azione fotocatalitica che si attiva alla luce naturale. Ogni soluzione outdoor progettata con ADVANCE® **contribuisce a migliorare l'ambiente che ci circonda.** Una tecnologia sicura per la nostra salute e una scelta sostenibile e attenta all'ambiente, in quanto realizzata in un'unica cottura ad altissima temperatura, senza perciò la necessità di ulteriori trattamenti e relativi impatti sull'ambiente.

UNI 11484 ATTESTED BY THE UNIVERSITY OF TURIN - DEPARTEMENT OF CHEMISTRY

EN *Reduction of atmospheric pollution*
CONVERTS VOLATILE POLLUTANTS INTO HARMLESS SUBSTANCES.

The anti-pollution properties of ADVANCE® stoneware also improve the quality of the air we breathe. Industrial production, the use of air conditioning systems and vehicles emit pollutants into the atmosphere. ADVANCE® used outdoors on the façades of buildings and apartment blocks, **reduces NOx (nitrogen oxide) molecules by 20.7%** (as attested by the University of Turin) in just three hours, considerably improving air quality thanks to the photocatalytic action activated by natural light. Each outdoor solution designed using ADVANCE® contributes towards **improving the environment around us.** The technology is not only safe for our health, but it is also a sustainable choice that takes care of the environment thanks to the single firing at a very high temperature, and because no further treatments are required and it has no further impact on the environment.

FR *Réduction de la pollution*
TRANSFORME LES POLLUANTS VOLATILS EN SUBSTANCES INOFFENSIVES.

Les propriétés antipollution du grès ADVANCE® améliorent également la qualité de l'air que nous respirons. La production industrielle, l'usage de systèmes de climatisation et l'utilisation des moyens de transport émettent des polluants atmosphériques. La technologie ADVANCE®, appliquée sur les façades extérieures des habitations et des bâtiments, permet de **réduire la concentration de molécules de NOx (oxydes d'azote) de 20,7%** (comme l'a confirmé l'Université de Turin) en seulement trois heures, ce qui permet d'améliorer de façon considérable la qualité de l'air grâce à l'action photocatalytique qui s'active à la lumière naturelle. Les espaces extérieurs conçus avec ADVANCE® permettent **d'améliorer l'environnement qui nous entoure.** En plus d'être sûre pour notre santé, la technologie représente également un choix durable et respectueux de l'environnement étant donné qu'elle est réalisée lors d'une cuisson unique à très haute température et qu'elle ne nécessite pas de traitements ultérieurs : elle n'engendre donc pas d'impacts supplémentaires sur l'environnement.

DE *Reduzierte Umweltverschmutzung*
FLÜCHTIGE SCHADSTOFFE WERDEN IN UNBEDENKLICHE STOFFE UMGEWANDELT.

Die schadstoffmindernden Eigenschaften des Feinsteinzeugs ADVANCE® verbessern auch die Qualität unserer Atemluft. Die industrielle Produktion, der Einsatz von Klimaanlage und die Transportmittel tragen zum Ausstoß von Schadstoffen in die Luft bei. Durch die Verwendung von ADVANCE® in Außenbereichen, an den Fassaden von Wohnungen und Gebäuden, **können die NOx-Moleküle (Stickstoffoxid) in nur drei Stunden um 20,7% reduziert werden** (laut Bescheinigung der Universität Turin). Durch die von natürlichem Licht aktivierte photocatalytische Wirkung kann die Qualität der Luft so beachtlich verbessert werden. Alle mit ADVANCE® realisierten Outdoor-Lösungen **tragen zu einer Verbesserung unserer Umwelt bei.** Diese Technologie ist nicht nur sicher für unsere Gesundheit, sondern auch eine nachhaltige und umweltfreundliche Entscheidung, da sie einen einzigen Brennvorgang bei extrem hohen Temperaturen vorsieht, ohne Notwendigkeit nachfolgender Behandlungen und damit ohne weitere Umweltauswirkungen.

Combate lo sporco



RIDUCE LA NECESSITÀ DI DETERGENTI CHIMICI.

Lo sporco si disgrega sulle superfici ceramiche ADVANCE® e ciò permette di mantenere puliti i pavimenti e i rivestimenti tramite il solo utilizzo di acqua e sapone neutro. Per i pavimenti esterni lo scorrere dell'acqua piovana è sufficiente per garantirne la pulizia.

EN *Combats dirt*
REDUCES THE NEED TO USE CHEMICAL DETERGENTS.

Dirt disintegrates on the surface of ADVANCE® tiles, floors and walls can be kept clean by just washing with a neutral soap and water. For outdoor floors, the flow of rainwater is enough to guarantee cleanliness.

FR *Combat la saleté*
RÉDUIT LE RECOURS AUX DÉTERGENTS CHIMIQUES.

La saleté se décompose sur les surfaces en céramique ADVANCE®, ce qui permet de conserver un sol et des murs propres en les lavant uniquement à l'eau et au savon doux. Pour les sols extérieurs, l'écoulement de l'eau de pluie suffit à garantir une propreté optimale.

DE *Bekämpft Schmutz*
REDUZIERT DEN EINSATZ CHEMISCHER REINIGUNGSMITTEL.

Der Schmutz zersetzt sich auf den Keramikoberflächen von ADVANCE®. So können Bodenbeläge und Wandverkleidungen einfach mit Wasser und einem neutralen Reinigungsmittel sauber gehalten werden. Bei Bodenbelägen im Außenbereich garantiert bereits das Abfließen von Regenwasser eine ausreichende Reinigung.

Combate i cattivi odori

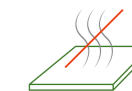

TRASFORMA LE MOLECOLE ORGANICHE RIDUCENDO I CATTIVI ODORI.

Come per gli NOx, le molecole fonti di cattivi odori si decompongono non appena entrano in contatto con la superficie, attenuandone così l'effetto odorigeno.

EN *Mitigates bad odours*
REDUCES BAD ODOURS BY CONVERTING THE ORGANIC MOLECULES.

Furthermore, as for NOx molecules, the molecules that cause bad odours decompose as soon as they come into contact with the surface, thus mitigating any malodorous effect.

FR *Réduit les mauvaises odeurs*
TRANSFORME LES COMPOSÉS ORGANIQUES ET RÉDUIT LES MAUVAISES ODEURS.

Comme pour les NOx, les composés à l'origine des mauvaises odeurs se décomposent dès qu'ils entrent en contact avec la surface, réduisant ainsi les mauvaises odeurs.

DE *Hemmt üble Gerüche.*
VERWANDELT ORGANISCHE MOLEKÜLE UND REDUZIERT SO ÜBLE GERÜCHE.

Ebenso wie die NOx-Moleküle zersetzen sich auch die für üble Gerüche verantwortlichen Moleküle, sobald sie mit der Oberfläche in Kontakt kommen und hemmen somit die Geruchsbildung.



Tante facce tutte differenti

La gamma dei colori e dei materiali in gres porcellanato prevedono la presenza di grafiche differenti per garantire un autentico effetto naturale su grandi e piccole estensioni di superficie.

EN_ *Endless looks, all different*

The range of colours and materials in porcelain stoneware slabs feature different graphics to create a realistic, natural feel in large and small areas.

FR_ *De nombreuses facettes toutes différentes*

La gamme des couleurs et des matériaux en grès cérame prévoit la présence de graphismes différents pour garantir un effet naturel authentique sur les petites et grandes surfaces.

DE_ *Viele verschiedene Seiten*

Die Palette der durch die Platten Farben und Materialien sehen das Vorhandensein von unterschiedlichen Grafiken vor, um einen authentischen natürlichen Effekt auf großen und kleinen Oberflächen hervorzurufen.

AESTHETICA WILDE

La stuoia

Per particolari applicazioni, per aumentare la resistenza meccanica al carico ed alla rottura, la lastra può essere fornita con stuoia in fibra di vetro applicata in retro.

EN_ *Fiber glass mesh*

For specific applications and in order to further increase their breaking strength, slabs can be supplied with a fiber glass mesh already fixed on their back.

FR_ *La fibre de verre*

En cas d'utilisations particulières, pour augmenter la résistance mécanique à la charge et à la rupture, la plaque peut être fournie avec une fibre de verre appliquée sur le dos.

DE_ *Glasfasernetz*

Für besondere Anwendungsbereiche kann die Rückseite der Platte auch mit einem Glasfasernetz bestückt werden, um die Bruchlast und den mechanischen Widerstand zu erhöhen.





Chevron XL & chevron

Il formato XL 85x15 cm, insieme al formato 7,5x40,7 cm (che può essere combinato con il listello 7,5x45 cm), offre la possibilità di creare diverse configurazioni, ideali sia per il pavimento che per il rivestimento, arricchendo gli ambienti con un design artigianale.

EN The extra-large 85x15 cm tiles and the 7,5x40,7 cm ones (which can be paired with the 7,5x45 cm strip), let you create lots of different looks, perfect for both floors and walls. It gives your space a really cool, handmade feel.

FR Les grands carreaux 85x15 cm et ceux de 7,5x40,7 cm (qui peuvent être associés à la liste 7,5x45 cm), permettent de créer de nombreuses configurations différentes, idéales pour les sols et les murs. Ça donne à votre espace un style vraiment sympa et artisanal.

DE Die extragroßen Fliesen in 85x15 cm, zusammen mit den 7,5x40,7 cm Fliesen (die mit der 7,5x45 cm Leiste kombiniert werden können), ermöglichen viele verschiedene Gestaltungsmöglichkeiten, sowohl für Böden als auch für Wände. Das verleiht deinem Raum eine echt coole, handgemachte Atmosphäre.

Avvertenze per la posa

Prima della posa controllare tonalità, calibro e scelta. Si consiglia di prelevare piastrelle alternativamente da più scatole. Non si accettano reclami relativi a materiale già posato.

EN_Laying warnings

Before laying, check the colour tones, work size, and quality category. It is advisable to take tiles from multiple boxes alternately. No claims will be entered into for laid tiles.

FR_Avertissements pour la pose

Avant la pose, vérifier la teinte, le calibre et le choix. Il est recommandé de prélever des carreaux en alternance dans plusieurs boîtes. Les réclamations concernant le matériel déjà posé ne sont pas admises.

DE_Hinweise für die Verlegung

Prüfen Sie vor der Verlegung Farbton, Dicke und Qualität. Es wird geraten, die Fliesen abwechselnd aus mehreren Kartons zu entnehmen. Reklamationen bezüglich bereits verlegtem Material werden nicht angenommen.

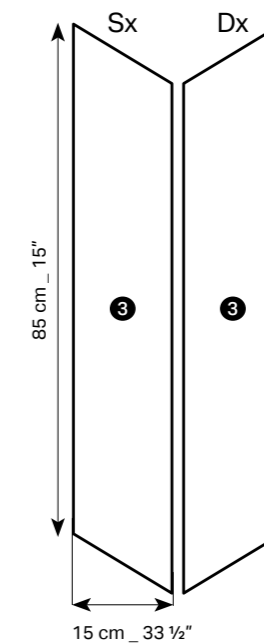

8,8 mm

3 Chevron XL
15x85_6"x33 1/2"

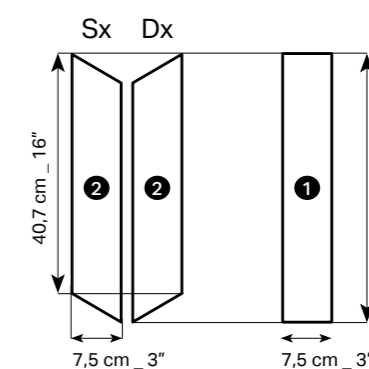

8,8 mm

1 Listello
7,5x45_3"x18"

2 Chevron
7,5x40,7_3"x16"

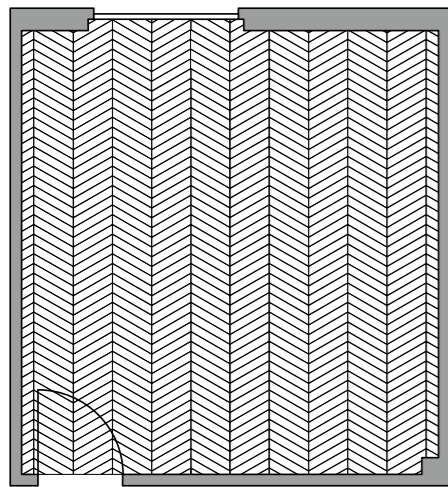

Posa chevron semplice

EN_Basic chevron design
FR_Pose en chevron simple
DE_Einfache chevron-verlegung

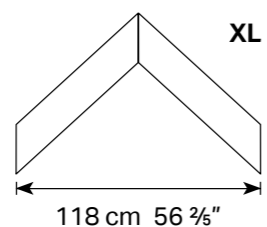

Dx/Sx
100%

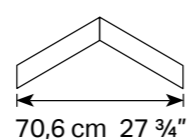

Dx/Sx
100%

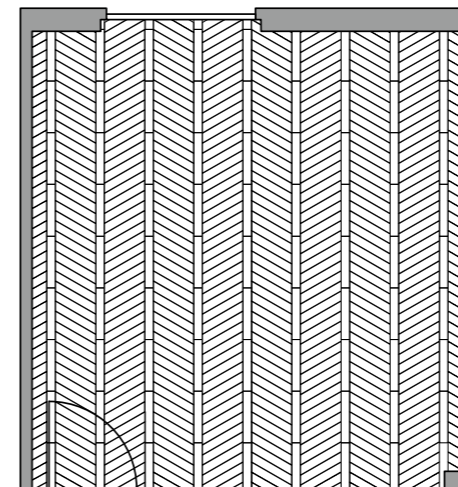

Posa chevron con tappeto

EN_Chevron design with rug effect
FR_Pose en chevron avec tapis
DE_Chevron-verlegung mit teppich

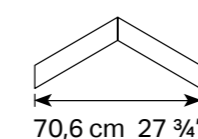

Dx/Sx
83%

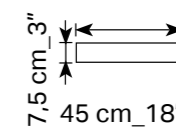

7,5x45
17%

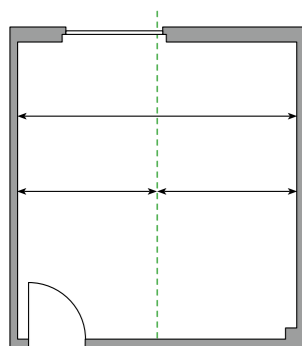

1

Misurare con precisione la larghezza dell'ambiente e tracciare una linea in corrispondenza della mezzera, come illustrato.

EN_Carefully measure the width of the room and draw the centre line, as shown.

FR_Mesurer la largeur de la pièce avec précision et tracer une ligne au centre d'après l'illustration.

DE_Messen Sie genau die Breite des Raumes und markieren Sie, wie gezeigt, die Mittellinie.

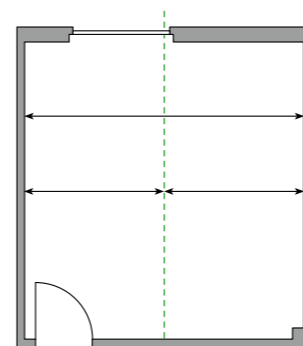

1

Misurare con precisione la larghezza dell'ambiente e tracciare una linea in corrispondenza della mezzera, posare la prima fila di 7,5x45 come illustrato.

EN_Carefully measure the width of the room and draw the centre line, as shown, then lay the first column.

FR_Mesurer la largeur de la pièce avec précision et tracer une ligne au centre, poser la première rangée de 7,5x45, d'après l'illustration.

DE_Messen Sie genau die Breite des Raumes und markieren Sie die Mittellinie. Verlegen Sie, wie gezeigt, die erste Reihe von 7,5x45.

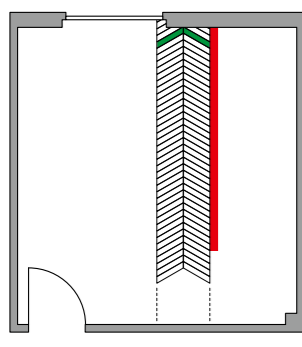

2

Posare il primo Chevron come illustrato. Utilizzare una staggia adeguatamente posizionata come guida. Proseguire la posa fino a terminare la sezione lasciando uno spazio libero per la via d'uscita.

EN_Lay the first chevron as illustrated. Place a levelling bar in position and use as a guide. Keep on laying until you reach the end of the section, leaving room to leave through.

FR_Poser le premier Chevron d'après l'illustration. Utiliser une règle correctement positionnée servant de guide. Poursuivre la pose jusqu'à ce que la section soit terminée en laissant un espace libre pour pouvoir sortir.

DE_Verlegen Sie, wie gezeigt, das erste Chevron. Verwenden Sie ein angemessen positioniertes Zieheisen als Führung. Setzen Sie die Verlegung bis zum Ende des Abschnitts fort und lassen Sie einen Freiraum als Ausgang.

Staggia / Levelling bar / Barre / Zieheisen

Inizio posa Chevron / Start chevron laying / Début de pose Chevron / Beginn der Chevron-Verlegung

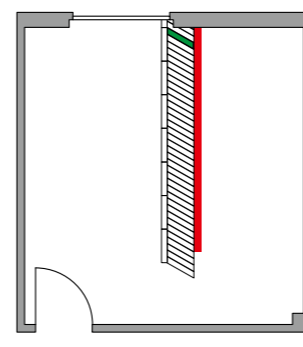

2

Utilizzare una staggia adeguatamente posizionata come guida e posare la prima fila di Chevron come illustrato, lasciando uno spazio libero per la via d'uscita.

EN_Use a levelling bar positioned as a guide, lay the first column of chevrons, as shown, leaving room to leave through.

FR_Utiliser une règle correctement positionnée servant de guide et poser la première rangée de Chevrons d'après l'illustration, en laissant un espace libre pour pouvoir sortir.

DE_Verwenden Sie ein angemessen positioniertes Zieheisen als Führung und verlegen Sie, wie gezeigt, die erste Reihe Chevron, wobei Sie einen Freiraum als Ausgang lassen.

Staggia / Levelling bar / Barre / Zieheisen

Inizio posa Chevron / Start chevron laying / Début de pose Chevron / Beginn der Chevron-Verlegung

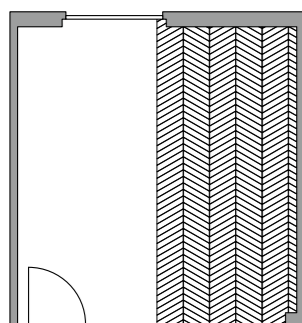

3

Completare la posa della prima metà della stanza, posando una sezione alla volta, sempre con l'aiuto di una staggia adeguatamente posizionata.

EN_Finish laying the first half of the room, laying one section at a time, using a suitably positioned levelling bar.

FR_Terminer l'installation de la première moitié de la pièce, en posant une section à la fois, toujours à l'aide d'une règle correctement positionnée.

DE_Komplettieren Sie die Verlegung in der ersten Hälfte des Zimmers, indem Sie jeweils einen Abschnitt mithilfe eines entsprechend positionierten Zieheisens verlegen.

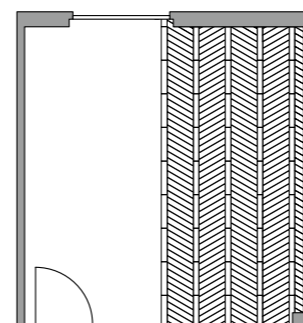

3

Completare la posa della prima metà della stanza, posando una sezione alla volta, sempre con l'aiuto di una staggia adeguatamente posizionata.

EN_Finish laying the first half of the room, laying one section at a time, using a suitably positioned levelling bar.

FR_Terminer l'installation de la première moitié de la pièce, en posant une section à la fois, toujours à l'aide d'une règle correctement positionnée.

DE_Komplettieren Sie die Verlegung in der ersten Hälfte des Zimmers, indem Sie jeweils einen Abschnitt mithilfe eines entsprechend positionierten Zieheisens verlegen.

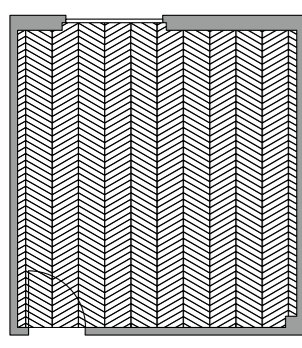

4

Con le stesse modalità, terminare la posa dell'ambiente.

EN_Proceeding in this fashion, finish laying the room.

FR_Terminer la pose du carrelage dans la pièce en suivant les mêmes modalités.

DE_Stellen Sie mit der gleichen Vorgehensweise die Verlegung im Raum fertig.

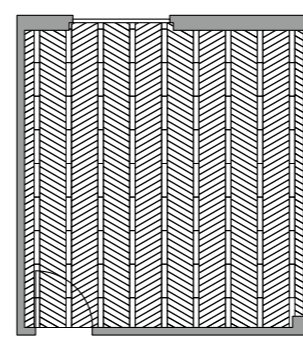

4

Con le stesse modalità, terminare la posa dell'ambiente.

EN_Proceeding in this fashion, finish laying the room.

FR_Terminer la pose du carrelage dans la pièce en suivant les mêmes modalités.

DE_Stellen Sie mit der gleichen Vorgehensweise die Verlegung im Raum fertig.

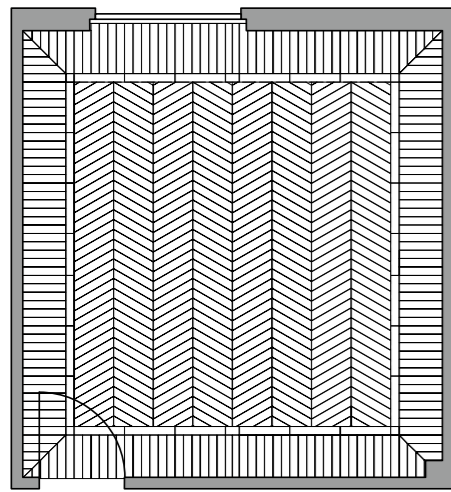

Posa chevron con tappeto

EN_Chevron design with rug effect
FR_Pose en chevron avec tapis
DE_Chevron-verlegung mit teppich

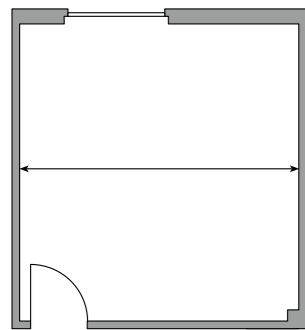
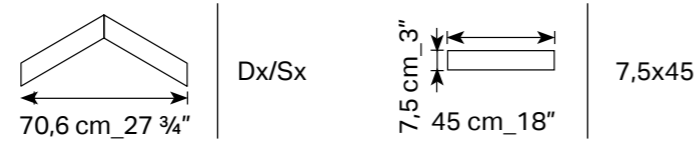

1

Misurare con precisione la larghezza dell'ambiente come illustrato.

EN_Carefully measure the width of the room, as shown.
FR_Mesurer la largeur de la pièce avec précision d'après l'illustration.
DE_Messen Sie, wie gezeigt, genau die Breite des Raumes.

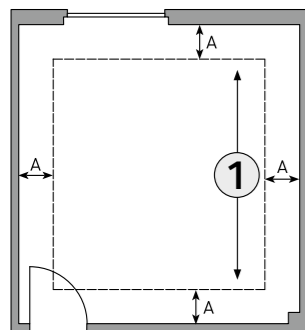

2

Tracciare l'area che dovrà contenere il tappeto centrale, assicurandosi di mantenere per ogni lato la medesima distanza dalle pareti, nel seguente modo:

- Sottrarre sempre la misura costante di 105 cm dalla misura della larghezza dell'ambiente (da esempio 375-105=270).

- Dividere la misura così ottenuta per la lunghezza dello Chevron che è 70,6 cm ($270/70,6=3,8$).
- Arrotondare il risultato all'intero superiore, quindi 3,8 diventa 4.
- Moltiplicare la lunghezza dello Chevron per il numero appena ricavato ($70,6*4=282,4$).
- Per determinare la distanza A (come da esempio) del tappeto centrale rispetto alle pareti, occorre sottrarre il risultato ottenuto dalla larghezza dell'ambiente e dividerlo per 2. Quindi la distanza A sarà: $(375-282,4)/2=46,3$ cm.

1

Senso di posa.
Laying direction.
Sens de pose.
Verlegerichtung.

EN_Mark out the central rug effect area, making sure to keep the same distance from the walls for each side, as follows:

- Always subtract 105 cm from the width of the room (for example room measuring 375 cm: $375-105=270$).
- Then divide the result obtained by the length of the chevron (which is 70.6 cm), e.g. $270 \div 70.6 = 3.8$.
- Round the result up to the nearest whole number, which means 3.8 becomes 4.
- Multiply the length of the chevron by the number just obtained ($70.6 \times 4 = 282.4$).
- To calculate the distance A (as shown in the example) between the central rug section and the walls, subtract the result obtained from the width of the room and then divide it by 2. Distance A will therefore be: $(375-282.4)/2=46.3$ cm.

FR_Tracer la zone qui contiendra le tapis central, en veillant à garder la même distance des murs, comme suit:

- Toujours soustraire la mesure constante de 105 cm de la mesure de la largeur de la pièce (par exemple 375-105=270).

- Diviser la mesure ainsi obtenue par la longueur du Chevron qui est de 70,6 cm ($270/70,6=3,8$).
- Arrondir le résultat à l'entier supérieur : 3,8 devient ainsi 4.
- Multiplier la longueur du Chevron par le nombre qu'on vient d'obtenir ($70,6*4=282,4$).
- Pour déterminer la distance A (comme dans l'exemple) du tapis central par rapport aux murs, il faut soustraire le résultat obtenu de la largeur de la pièce et le diviser par 2. La distance A sera donc : $(375-282,4)/2=46,3$ cm.

DE_Markieren Sie den Bereich, in dem sich der mittlere Teppich befinden soll, und vergewissern Sie sich auf folgende Weise, dass auf jeder Seite den gleichen Abstand zu den Wänden eingehalten wird:

- Ziehen Sie stets das konstante Maß von 105 cm von der gemessenen Raumbreite ab (zum Beispiel 375-105=270).
- Teilen Sie das so erhaltene Maß durch die Länge des Chevron, die 70,6 cm beträgt ($270/70,6=3,8$).
- Runden Sie das Ergebnis nach oben auf eine ganze Zahl, d.h. 3,8 wird 4.
- Multiplizieren Sie die Länge des Chevron mit der gerade ermittelten Zahl ($70,6*4=282,4$).
- Zur Bestimmung des Abstandes A (gemäß Beispiel) des mittleren Teppichs von den Wänden muss das erzielte Ergebnis von der Raumbreite abgezogen und durch 2 geteilt werden. Somit beträgt der Abstand A: $(375-282,4)/2=46,3$ cm.

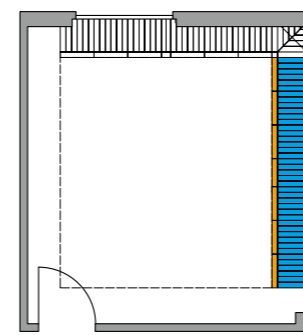

3

Iniziare la posa di fascia e bindello fino a completare due lati dell'ambiente come illustrato, avendo l'accortezza di posare l'eventuale pezzo tagliato contro la parete, in modo da poter poi coprire il taglio con il battiscopa.

EN_Begin laying the outer border band and the inner border line, to complete two sides of the room as illustrated, taking care to lay the cut piece against the wall so that the cut can then be covered with the skirting board.
FR_Commencer la pose des lames de bordure et de raccord et compléter les deux côtés d'après l'illustration, en prenant soin de poser chaque pièce coupée contre le mur, de manière à pouvoir couvrir le côté coupé avec la plinthe.

DE_Beginnen Sie, wie gezeigt, mit der Verlegung des äußeren Streifens und des inneren Randes bis zur Fertigstellung von zwei Seiten des Raumes. Achten Sie dabei darauf, dass eventuell geschnittene Stück zur Wand zu richten, so dass der Schnitt später mit der Sockelleiste verdeckt werden kann.

Bindello / Inner border line / Lame de raccord / Innerer Rand

Fascia / Outer border band / Lame de bordure / Äußerer Streifen

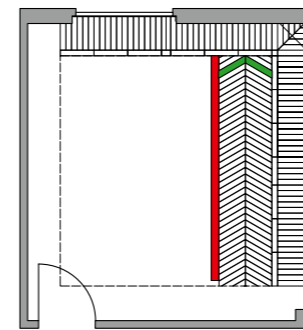

4

Posare il primo Chevron del tappeto centrale come evidenziato in figura. Utilizzare il bindello posato in precedenza e una staggia adeguatamente posizionata come guida. Proseguire la posa fino a terminare l'intera sezione.

EN_Lay the first chevron of the central 'rug' section as shown in the figure. Use the inner border line laid earlier and a suitably positioned levelling bar as a guide. Keep laying until the entire section is finished.

FR_Poser le premier Chevron du tapis central d'après la figure. Utiliser la lame de raccord posée précédemment et une règle correctement positionnée servant de guide. Continuer la pose pour terminer l'ensemble de la section.

DE_Verlegen Sie das erste Chevron des mittleren Teppichs, wie in der Abbildung gezeigt. Verwenden Sie der zuvor verlegte innere Rand und ein angemessen positioniertes Zieheisen als Führung. Setzen Sie die Verlegung bis zur Fertigstellung des gesamten Bereichs fort.

Staggia / Levelling bar / Barre / Zieheisen

Inizio posa Chevron / Start chevron laying / Début de pose Chevron / Beginn der Chevron-Verlegung

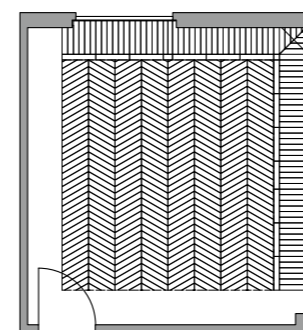

5

Terminare in questo modo l'intera posa del tappeto centrale.

EN_Proceeding in this fashion, finish laying the entire central 'rug' section.

FR_Terminer la pose du tapis central suivant cette modalité.

DE_Beenden Sie auf diese Weise die gesamte Verlegung des mittleren Teppichs.

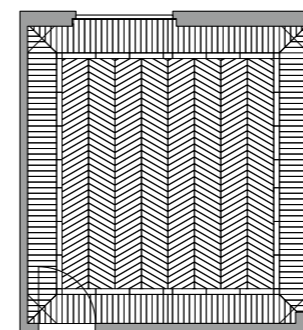

6

Concludere la stanza con la posa di fascia e bindello mancanti.

EN_Finish the room by laying the missing part of the outer border band and the inner border line.

FR_Conclure la pièce en posant les lames de bordure et de raccord manquantes.

DE_Stellen Sie den Raum durch Verlegung der äußeren Streifen und inneren Ränder fertig, die verbleiben.

Schemi di posa

EN_ Laying sketch

FR_ Schémas de pose

DE_ Modulverlegungsbeispiele

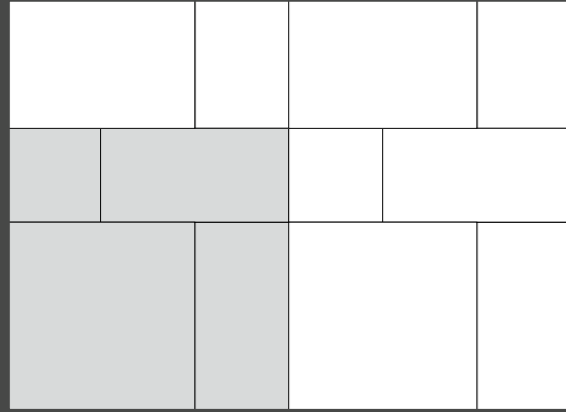

120x120=57,1%
60x120=28,6%
60x60=14,3%

A

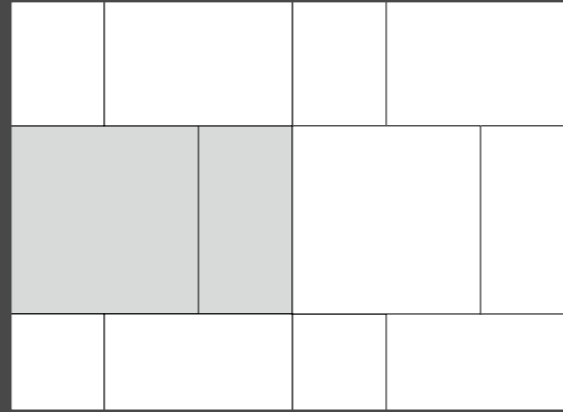

120x120=66,7% 100x100=66,7%
60x120=33,3% 50x100=33,3%

B

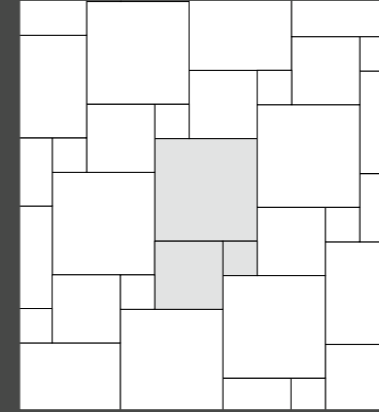

60,9x60,9=64,4%
40,6x40,6=28,6%
20,3x20,3=7%

I

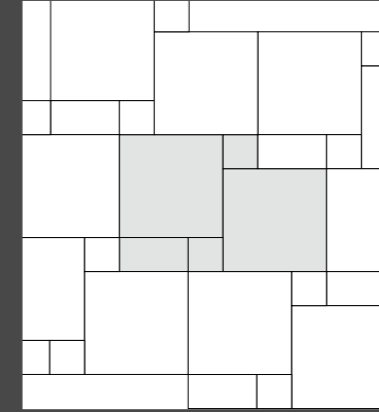

60,9x60,9=82%
20,3x40,6=9%
20,3x20,3=9%

J

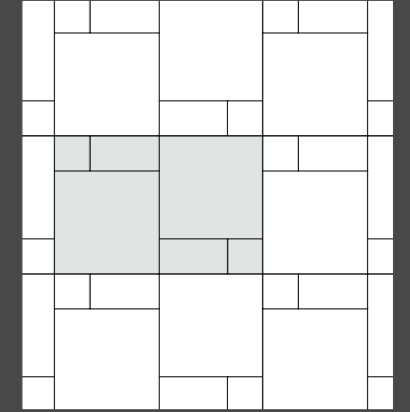

60,9x60,9=75%
20,3x40,6=16,7%
20,3x20,3=8,3%

K

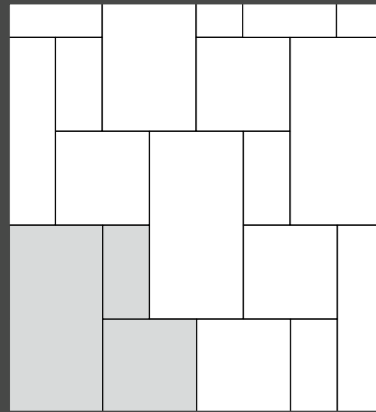

60x120=57,1%
60x60=28,6%
30x60=14,3%

C

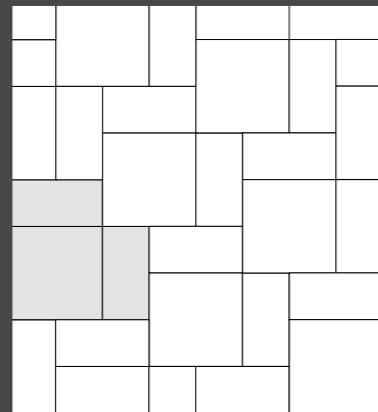

60x60=50%
30x60=50%

D

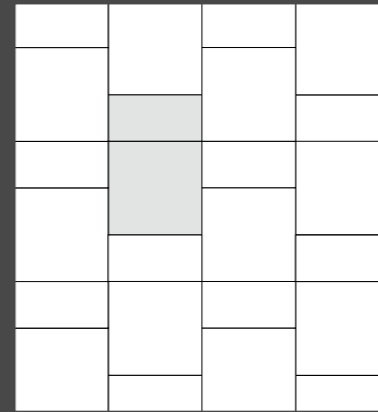

60x60=66,7%
30x60=33,3%

E

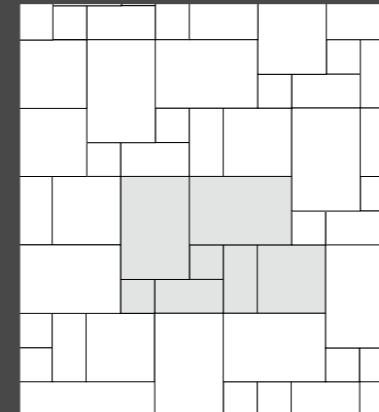

40,6x60,9=55%
40,6x40,6=18%
20,3x40,6=18%
20,3x20,3=9%

L

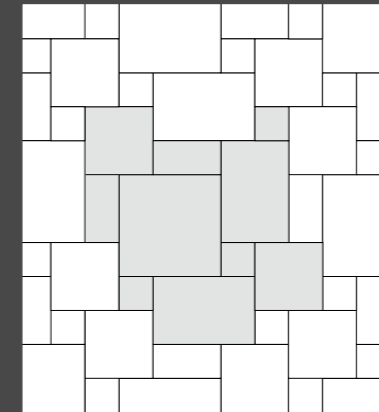

60,9x60,9=25%
40,6x60,9=33,3%
40,6x40,6=22,2%
20,3x40,6=11,1%
20,3x20,3=8,3%

M

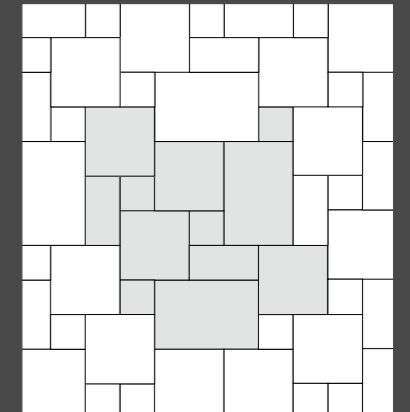

40,6x60,9=33,3%
40,6x40,6=44,5%
20,3x40,6=11,1%
20,3x20,3=11,1%

N

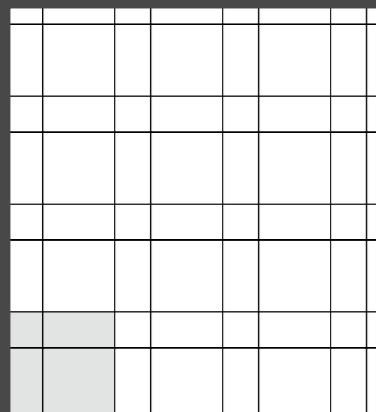

40,6x40,6=44,4%
20,3x40,6=44,4%
20,3x20,3=11,1%

F

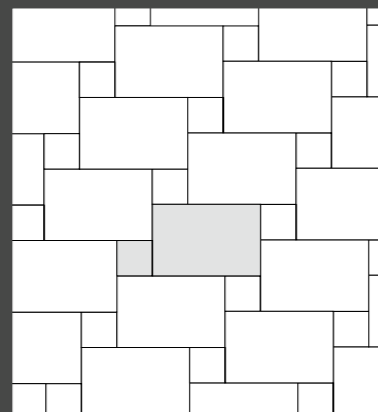

40,6x60,9=85,7%
20,3x20,3=14,3%

G

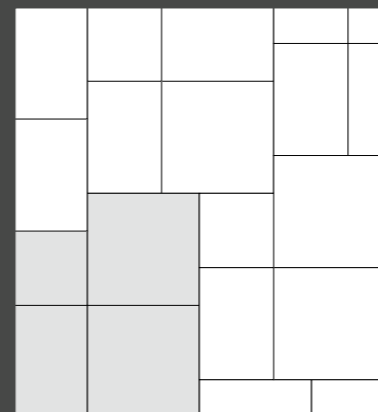

60,9x60,9 = 64,3%
40,6x60,9 = 21,4%
40,6x40,6 = 14,3%

H

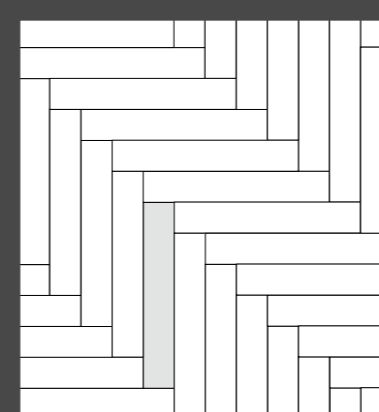

23x149=100%

O

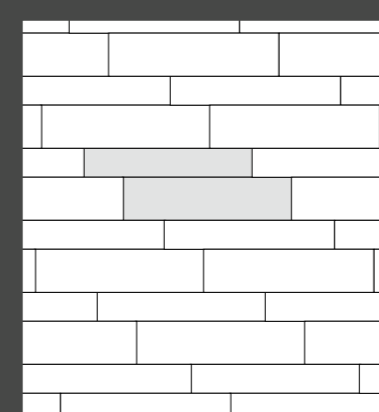

20x120=40%
30x120=60%

P

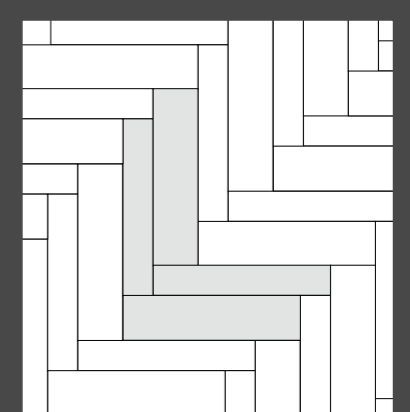

20x120=40%
30x120=60%

Q

20MM R11C

Sistemi di posa

EN_ Installation systems

FR_ Systèmes de pose

DE_ Verlegungsarten

Pavimento sopraelevato

Raised installation

Pose surélevée

Verlegen von Doppelboden

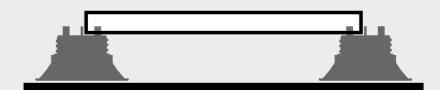

Posa a secco su erba

Dry installation on grass

Pose à sec sur l'herbe

Trockenverlegung auf gras



Posa a secco su ghiaia

Dry installation on gravel

Pose à sec sur gravier et sable

Trockenverlegung auf Kies

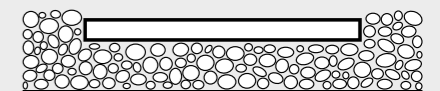

Posa a secco su sabbia

Dry placement on sand

Pose à sec sur la sable

Trockenverlegung auf Sand



Posa a colla tradizionale

Traditional laying with glue

Pose à colle traditionnelle

Verlegung mit Kleber



**Scarica il catalogo
Outdoor 2025**

EN_ Download the 2025 Outdoor catalog

FR_ Téléchargez le catalogue Outdoor 2025

DE_ Lade den Outdoor-Katalog 2025 herunter

La posa sopraelevata

I pavimenti sopraelevati sono la soluzione ideale per gli interventi di recupero edilizio e per i nuovi edifici. I loro vantaggi sono molteplici: sono **semplici e veloci da posare** e altrettanto **rapidi da rimuovere** per l'eventuale manutenzione di cavi e tubature o per ispezionare lo strato impermeabilizzante. Inoltre, **assorbono le dilatazioni** ed i movimenti strutturali, evitando crepe e rotture, e **favoriscono il ricircolo dell'aria** nello spazio tra la pavimentazione e l'impermeabilizzazione.



EN_Raised laying

Raised floors are the ideal solution for building renovations and new buildings. Their advantages are many: they are simple and quick to install and just as quick to remove for any maintenance of cables and pipes or to inspect the waterproofing layer. Moreover, they absorb expansions and structural movements, thus preventing cracks and breaks, and facilitate air recirculation between the floor and the waterproofing layer.

FR_La pose surélevée

Les planchers surélevés sont la solution idéale pour les interventions de récupération des bâtiments et pour les nouveaux bâtiments. Leurs avantages sont nombreux: ils sont simples et rapides à poser et tout aussi rapides à enlever pour l'entretien éventuel des câbles et tuyaux ou pour inspecter la couche d'étanchéité. De plus, ils absorbent la dilatation et les mouvements structurels, évitant les fissures et les cassures, et favorisent la recirculation de l'air dans l'espace entre le revêtement de sol et l'imperméabilisation.

DE_Verlegung als Doppelboden

Aufgestellte Bodenbeläge sind die ideale Lösung für Sanierungsarbeiten und Neubauten. Ihre Vorteile sind vielfältig: Sie lassen sich schnell und einfach verlegen und können ebenso schnell wieder entfernt werden, wenn Arbeiten an Kabeln und Rohren durchzuführen sind oder die Abdichtungsschicht geprüft werden muss. Außerdem werden Ausdehnungen und Bewegungen ausgeglichen, wodurch Risse und Brüche vermieden werden, und die Luftzirkulation zwischen Belag und Abdichtungsebene wird erleichtert.



Il sistema per la posa di pavimentazioni sopraelevate, MAXI in tutto

PP level DUO MAXI è una **gamma di supporti regolabili per pavimenti sopraelevati da esterno** progettata e prodotta da Profilpas. MAXI flessibilità: grazie al comodo anello Fixed Head Ring, si può trasformare la testa autolivellante, capace di compensare pendenze di superficie fino al 5%, in testa fissa, direttamente in fase di posa. MAXI tenuta: il supporto garantisce un'eccellente resistenza ai grandi carichi ed agli agenti atmosferici. MAXI versatilità: numerosi accessori a disposizione per qualsiasi esigenza di posa, dalle prolunghe ai travetti in alluminio, passando per i tappetini in gomma e le clip in acciaio. Con PP level DUO MAXI la posa del pavimento sopraelevato risulterà agevole, veloce e a regola d'arte.

EN_The system for the installation of raised floors, maxi in everything

PP level DUO MAXI is a range of adjustable supports for outdoor raised floors designed and produced by Profilpas. MAXI flexibility: thanks to the practical Fixed Head Ring, you can transform the self-levelling head, able to compensate for surface slopes up to 5%, into fixed head, directly during the installation. MAXI strength: the support guarantees excellent resistance to heavy loads and weather elements. MAXI versatility: numerous accessories are available for any installation requirement, from extensions to aluminium joists, rubber mats and steel clips. With PP level DUO MAXI the installation of the raised floor will be easy, fast and perfect.

FR_Le système de pose de planchers surélevés, maxi dans tous

PP level DUO MAXI est une gamme de supports réglables pour sols extérieurs surélevés conçus et fabriqués par Profilpas. Flexibilité MAXI: grâce à la bague de tête fixe pratique, la tête basculante, capable de compenser les pentes de surface jusqu'à 5%, peut être transformée en tête fixe, directement lors de l'installation. Force MAXI: le support garantit une excellente résistance aux charges importantes et aux agents atmosphériques. Polyvalence MAXI: nombreux accessoires disponibles pour tout besoin d'installation, des rallonges aux solives d'aluminium, en passant par les tapis de caoutchouc et les clips d'acier. Avec PP level DUO MAXI, l'installation du plancher surélevé sera facile, rapide et professionnelle.

DE_Das System zur Stelzlagerverlegung, maximal in allen Belangen

Für aufgestellte Bodenbeläge im Außenbereich bietet das PP level DUO MAXI System eine große Auswahl an, die von Profilpas entwickelt und hergestellt werden. MAXIMALE Flexibilität: Dank des Arretierelements Perfect Ring kann der selbstnivellierende Kopf, der eine Oberflächenneigung von bis zu 5% ausgleichen kann, direkt beim Verlegen zu einem Festkopf umfunktioniert werden. MAXIMALE Haltbarkeit: Die Stelzlagerstützen verfügen über eine hohe Druckfestigkeit und bieten eine ausgezeichnete Widerstandsfähigkeit gegen Witterungseinflüsse. MAXIMALE Vielseitigkeit: Umfangreiches Zubehör für alle Verlegeanforderungen, von Verlängerungselementen über Aluminiumträger bis hin zu Gummipads und Stahlklammern. PP level DUO MAXI ermöglicht eine einfache, schnelle und präzise Verlegung von selbsttragenden Bodenbelägen aus Keramik, Naturwerkstein, Holz oder anderen Materialien.



SUPPORTO CON TESTA FISSA

FIXED HEAD SUPPORT
SUPPORT AVEC TÊTE FIXE
TRAGER MIT FESTEM KOPF



SUPPORTO CON TESTA AUTOLIVELLANTE

SELF-LEVELLING HEAD SUPPORT
SUPPORT AVEC TÊTE BASCULANTE
TRAGER MIT SELBSTNIVELLIERENDEM KOPF

Supporti per ogni esigenza di posa

EN *Supports for any installation requirement*

FR *Prise en charge de tous les besoins d'installation*

DE *Stelzlager für jede Verlegeanforderung*

TESTA AUTOLIVELLANTE PER PAVIMENTI IN CERAMICA

Testa da utilizzare per la posa di pavimenti in ceramica, dotata di alette facilmente removibili per fughe da 2, 3 e 4 mm e di gomma antirumore e antiscivolo termosaldata per un maggior comfort acustico e la massima stabilità.

EN SELF-LEVELLING HEAD FOR CERAMIC FLOORS

Head to be used for the installation of ceramic floors, equipped with easily removable tabs for 2, 3 and 4 mm joints and noise-proof, anti-slip, heat-sealed rubber for a greater acoustic comfort and maximum stability.

FR TÊTE AUTONIVELANTE POUR SOLS EN CÉRAMIQUE

Tête à utiliser pour la pose de sols en céramique, équipée d'ailettes facilement amovibles pour les joints de 2, 3 et 4 mm et de caoutchouc antibruit et antidérapant thermocollant pour un plus grand confort acoustique et une stabilité maximale.

DE SELBSTNIVELLIERENDER KOPF FÜR KERAMIK- UND NATURWERKSTEINBÖDEN

Der Kopf zur Verlegung von Keramik- oder Naturwerksteinplatten ist mit leicht entfernbaren Abstandshaltern für 2, 3 und 4 mm breite Fugen und mit heißversiegeltem, geräuschkämpfendem und rutschfestem Gummibelag versehen, der eine bessere Schalldämmung und maximale Stabilität des Bodens bewirkt.



201022

201023

201024

TESTA FISSA PER PAVIMENTI IN CERAMICA

Testa fissa da utilizzare per la posa di pavimenti in ceramica, dotata di alette facilmente removibili per fughe 4 mm. Ideale per pavimentazioni su superfici piane o nei casi in cui il pavimento debba essere parallelo alla superficie su cui poggia il supporto.

EN FIXED HEAD FOR CERAMIC FLOORS

Fixed head to be used for the installation of ceramic floors, equipped with easily removable tabs for 4 mm joints. It is ideal for floor coverings on flat surfaces or when the floor covering must be parallel to the surface on which the support lays.

FR TÊTE FIXE POUR SOLS CÉRAMIQUES

Tête fixe à utiliser pour la pose de sols céramiques, équipée d'ailettes facilement amovibles pour des joints de 4 mm. Idéale pour les revêtements de sol sur des surfaces planes ou lorsque le revêtement de sol doit être parallèle à la surface sur laquelle il repose.

DE FESTES KOPFSTÜCK FÜR KERAMIKBÖDEN

Fester Kopf für die Verlegung von Keramikböden, ausgestattet mit leicht abnehmbaren Lamellen für 4 mm Fugen. Ideal für Bodenbeläge auf ebenen Flächen oder wenn der Bodenbelag parallel zu der Fläche, auf der er liegt, verlegt werden muss.



201025

TESTA AD INCROCIO PER TRAVETTI IN ALLUMINIO

Testa ad incrocio da utilizzare con appositi travetti in alluminio, per la posa di pavimenti sopraelevati con listoni in ceramica mono- e multi-formato. Con questi travetti, dotati di binario per il posizionamento dei distanziatori, è possibile creare una sottostruttura capace di aumentare la stabilità e la portata.

EN CRISSCROSS HEAD FOR ALUMINIUM JOISTS

Crisscross head to be used with special aluminium joists, for the installation of raised floors with single- and multi-format ceramic planks. With these joists, equipped with a rail for positioning the spacers, it is possible to create a substructure that increases stability and load-bearing capacity.

FR TRAVERSE POUR LAMBOURDES EN ALUMINIUM

Solution idéale pour la pose de planchers surélevés avec des planches en céramique, à la fois mono et multi-format, à utiliser avec des lambourdes spéciales en aluminium équipées d'un rail pour l'entretoise. Avec ces solives, il est possible de créer une sous-structure capable d'augmenter la stabilité et la capacité de charge.

DE KREUZKOPF FÜR ALUMINIUMTRÄGER

Der Kreuzkopf eignet sich für die Montage von speziellen Aluminiumprofilen für die Verlegung von aufgestellten Bodenbelägen mit ein- und mehrformatigen Keramikdielen. Mit diesen Profilen, die mit einer Schiene zur Positionierung der Abstandshalter ausgestattet sind, kann eine Tragwerkstruktur erstellt werden, die die Stabilität und Tragfähigkeit erhöht.



201026



1. PP level DUO MAXI con testa autolivellante (cod. 201022, 201023, 201024) per la posa di pavimenti in ceramica.

EN *PP level DUO MAXI with self-levelling head (cod. 201022, 201023, 201024) for the installation of ceramic floors.*

FR *PP level DUO MAXI avec tête autonivelante (cod. 201022, 201023, 201024) pour la pose de sols en céramique.*

DE *PP level DUO MAXI mit dem selbstnivellierenden Kopf (cod. 201022, 201023, 201024) für die Verlegung von Keramik- und Naturwerksteinplatten.*



2. Sistema PP level DUO MAXI con testa ad incrocio (cod. 201026) e travetti in alluminio (cod. 201027) per la posa di listoni in ceramica mono e multi-formato.

EN *PP level DUO MAXI system with crisscross head (cod. 201026) and aluminium joists (cod. 201027) for the installation of single- and multi-format ceramic planks.*

FR *Système PP level DUO MAXI avec tête de croisement (cod. 201026) et solives en aluminium (cod. 201027), pour la pose de planches céramiques mono et multiformat.*

DE *PP level DUO MAXI-System mit Kreuzkopf (cod. 201026) und Aluminiumprofilen (cod. 201027) zur Verlegung von ein- und mehrformatigen Keramikdielen.*



3. Sistema PP level DUO MAXI con testa ad incrocio (cod.201026) e travetti in alluminio (cod. 201027) trasversali, per una maggiore stabilità in caso di altezze superiori a 40 cm.

EN *PP level DUO MAXI system with crisscross head (cod.201026) and aluminium crosswise joists (cod.201027), for greater stability at heights above 40 cm.*

FR *Système PP level DUO MAXI avec tête de croisement (cod.201026) et solives transversales en aluminium (cod.201027), pour une plus grande stabilité en cas de hauteurs supérieures à 40 cm.*

DE *Das PP level DUO MAXI-System mit Kreuzkopf (cod.201026) und Aluminiumprofilen (cod.201027) sorgt für zusätzliche Stabilität bei Höhen über 40 cm.*

Supporti di basso spessore

EN_Low-thickness supports

FR_Supports de faible épaisseur

DE_Dünne Stelzlager

SUPPORTO REGOLABILE A BASSO SPESSORE PP LEVEL MINI (FINO A 30 MM)

PP level MINI (cod. 201032) è un **supporto regolabile a testa fissa** e per altezze fino a 30 mm, a completamento della gamma. PP level MINI è regolabile in altezza da 10 a 15 mm, ma è ulteriormente estensibile fino a 30 mm inserendo un massimo di tre **prolunghe** (cod. 201033) da 5 mm ciascuna. PP level MINI è dotato di alette distanziatrici per fughe da 4 mm, facilmente removibili.



EN_LOW-THICKNESS ADJUSTABLE SUPPORT PP LEVEL MINI (UP TO 30 MM)

PP level MINI (cod. 201032) is an **adjustable, fixed-head support** for heights up to 30 mm, completing the range. PP level MINI is height-adjustable from 10 to 15 mm, but can be further extended up to 30 mm by inserting a maximum of three **extensions** (cod. 201033) of 5 mm each. PP level MINI is equipped with easily removable spacer tabs for 4 mm joints.

FR_SUPPORT RÉGLABLE DE FAIBLE ÉPAISSEUR PP LEVEL MINI (JUSQU'À 30 MM)

PP level MINI (cod. 201032) est un **support réglable avec tête fixe** et pour des hauteurs allant jusqu'à 30 mm, complétant la gamme. PP level MINI est réglable en hauteur de 10 à 15 mm, mais peut encore être extensible jusqu'à 30 mm en insérant un maximum de trois **rallonges** (cod. 201033) de 5 mm chacune. PP Level MINI est équipé d'ailettes d'espacement pour joints de 4 mm, facilement amovibles.

DE_DÜNNE HÖHENVERSTELLBARE STELZLAGER PP LEVEL MINI (BIS 30 MM)

PP level MINI (201032) ist ein **verstellbares Stelzlager** mit festem Kopf für Höhen bis 30 mm, der das Sortiment ergänzt. Der PP level MINI ist von 10-15 mm höhenverstellbar und kann durch die Verwendung von max. drei Höhenadapter (cod. 201033) von je 5 mm auf bis zu 30 mm erweitert werden. Die Abstandshalter am PP Level MINI Kopf sind für 4 mm breite Fugen und leicht zu entfernen.

SUPPORTO AD ALTEZZA FISSA SP

SP (cod. 201034) è un **supporto con altezza fissa** 14 mm. È la soluzione più semplice ed economica per la posa di qualsiasi pavimentazione da esterno autoportante. A seconda della conformazione del sottofondo, può essere utilizzato con i **livellatori** cod. 201035 (h. 1 mm) e cod. 201036 (h. 3 mm).

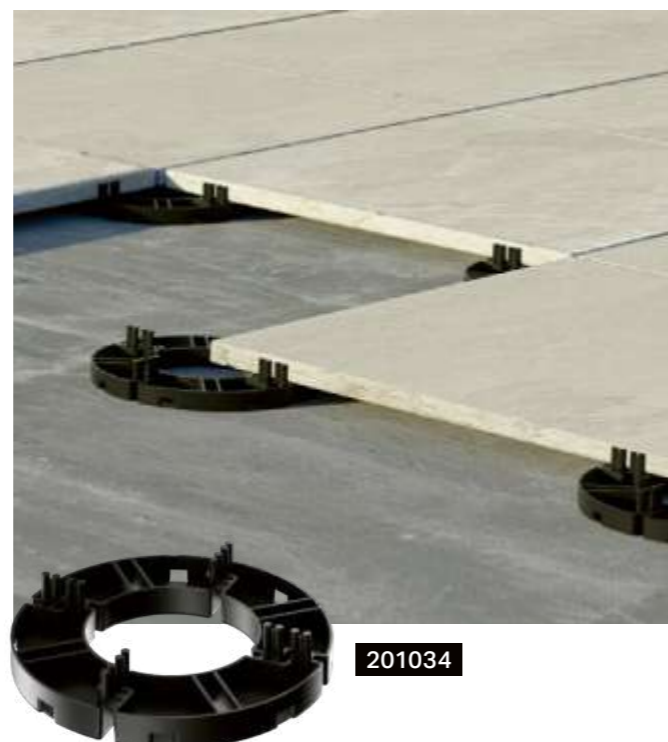

EN_FIXED-HEIGHT SUPPORT SP

SP (cod. 201034) is a **support with fixed height** of 14 mm. It is the simplest and cheapest solution for installing any self-supporting outdoor flooring. According to the conformation of the subfloor, it can be used with **levellers** with cod. 201035 (h. 1 mm) and 201036 (h. 3 mm).

FR_SUPPORT À HAUTEUR FIXE SP

SP (cod. 201034) est un **support d'une hauteur fixe** de 14 mm. C'est la solution la plus simple et la plus économique pour la pose de tout revêtement de sol extérieur autoportant. Selon la forme du support, il peut être utilisé avec **les niveleurs** cod. 201035 (1 mm d'épaisseur) et 201036 (3 mm d'épaisseur).

DE_STELZLAGER MIT FESTER HÖHE SP

SP (cod. 201034) ist ein **Stelzlager** mit einer festen Höhe von 14 mm. Dies ist die einfachste und wirtschaftlichste Lösung für die Stelzlagerverlegung im Außenbereich. Je nach Untergrundanforderung können die **Nivellierelemente** cod. 201035 (1 mm Höhe) und 201036 (3 mm Höhe) kombiniert werden.

Accessori per la posa

EN_Accessories for installation

FR_Accessoires d'installation

DE_Verlegezubehör

CHIAVE DI REGOLAZIONE

Grazie all'**apposita chiave**, i supporti PP level DUO MAXI con testa autolivellante per pavimenti in ceramica possono essere regolati in altezza anche a pavimento finito, per ottenere pavimentazioni perfettamente livellate. Per una regolazione più rapida, è disponibile un inserto in acciaio per avvitatore.



EN_ADJUSTMENT KEY

Thanks to the **special key**, PP level DUO MAXI supports with self-levelling head for ceramic floors can be adjusted in height even when the floor is finished, to achieve perfectly level floors. For faster adjustment, a steel insert for screwdriver drills is available.

FR_CLE DE REGLAGE

Grâce à la **clé spéciale**, les supports PP level DUO MAXI avec tête autonivelante pour sols en céramique peuvent être réglés en hauteur même lorsque le sol est terminé, pour obtenir des sols parfaitement nivelés. Pour un réglage plus rapide, un insert en acier pour tournevis est disponible.

DE_JUSTIERSCHLÜSSEL

Die **Höhenjustierung** der mit PP level DUO MAXI Stelzlager mit selbstnivellierendem Kopf verlegten Platten kann dank des speziellen Justierschlüssels auch bei bereits verlegten Bodenbelägen vorgenommen werden. So lassen sich absolut ebene Bodenbeläge erzielen. Für eine schnellere Höhennivellierung ist ein Bohrmaschinenaufsatz aus Stahl erhältlich.

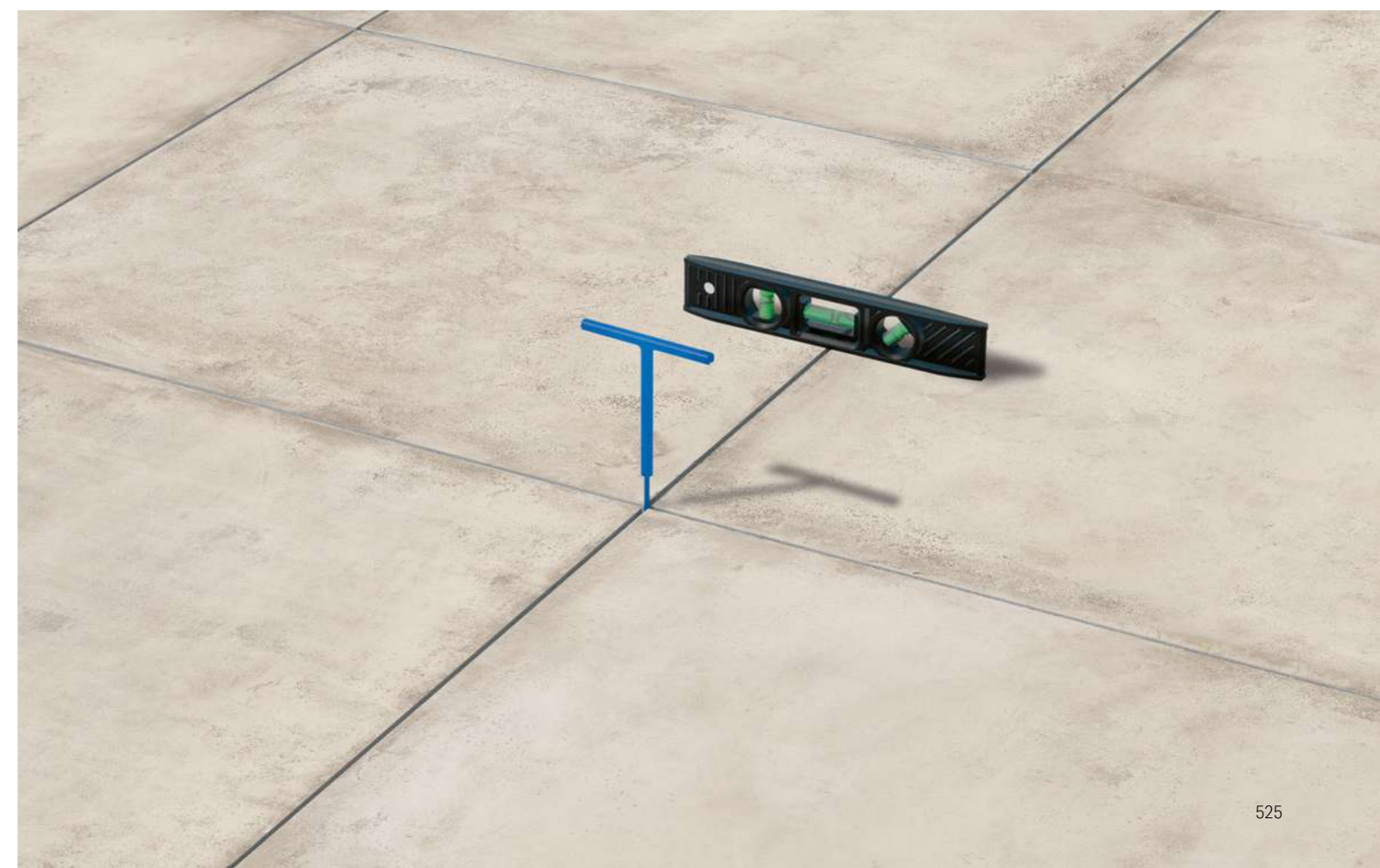

ACCESSORI PER LA POSA

EN_Accessories for installation

FR_Accessoires d'installation

DE_Verlegezubehör

CLIP PER LA CHIUSURA VERTICALE

Gli articoli con **cod. 201039** e **201040** sono due **kit di clip in acciaio inox** (testa+base) per il tamponamento verticale e angolare di pavimenti sopraelevati con piastrelle di 20 mm di spessore.



201039

201040

EN_CLIPS FOR VERTICAL CLOSURE

The items with **cod. 201039** and **201040** are **two stainless steel clip kits** (head + base) for vertical and angular closure of raised floors with 20 mm thick tiles.

FR_CLIP POUR FERMETURE VERTICALE

Les articles avec le **cod. 201039** et **201040** sont **deux kits de clips en acier inoxydable** (tête + base) pour la fermeture verticale et angulaire de planchers surélevés avec des carreaux de 20 mm d'épaisseur.

DE_CLIPHALTERUNGEN FÜR VERTIKALE VERBLENDPLATTEN

Die Artikel mit den **Artikelnummern 201039** und **201040** sind **zwei Kits aus Edelstahl-Clips** (Kopf + Sockel) für die Lineare und Ecksicherung von Verblendplatten für den Abschluss der vertikalen Stirnseiten bei der Stelzlagerverlegung für Plattendicken bis 20 mm.



DISTANZIATORE PERIMETRALE

Gli articoli con **cod. 201041** e **201042** sono **due clip**, rispettivamente **in acciaio inox** e **in polipropilene**, entrambe con funzione di distanziatore perimetrale, per ottenere fughe uniformi e lineari tra le piastrelle e il muro perimetrale.



201041

201042



EN_PERIMETER SPACER

The items with **cod. 201041** and **201042** are **two clips**, in **stainless steel and polypropylene** respectively, both with perimeter spacer function, to obtain uniform and linear joints between the tiles and the perimeter wall.

FR_ESPACEUR PERIMETRAL

Les articles avec le **cod. 201041** et **201042** sont **deux clips**, respectivement **en acier inoxydable et en polypropylène**, tous deux avec fonction d'entretoise périmétrale, pour obtenir des joints uniformes et linéaires entre les carreaux et le mur d'enceinte.

DE_WANDABSTANDSHALTER

Die Artikel mit den **Artikelnummern 201041** und **201042** sind **zwei Clips aus Edelstahl bzw. Polypropylen**, zur Sicherstellung einer geraden, ausreichend breiten Anschlussfuge zu den aufgehenden Bauteilen.

ACCESSORI PER LA POSA

EN_Accessories for installation

FR_Accessoires d'installation

DE_Verlegezubehör

TAPPETINO IN GOMMA

L'articolo con **cod. 201043** è un **tappetino in gomma** con diametro di 21 cm e spessore di 2 mm con funzione di abbattimento acustico.

EN_RUBBER MAT

The item with **cod. 201043** is a **rubber mat** with a diameter of 21 cm and a thickness of 2 mm with anti-noise function.

FR_TAPIS DE CAOUTCHOUC

L'article avec le **cod. 201043** est un **tapis en caoutchouc** d'un diamètre de 21 cm et d'une épaisseur de 2 mm avec fonction de réduction du bruit.

DE_GUMMIPAD

Der Artikel mit der **Artikelnummer 201043** ist ein **geräuschdämpfendes Gummipad** mit einem Durchmesser von 21 cm und einer Dicke von 2 mm.



201043

DISCO LIVELLANTE PER TESTA

L'articolo con **cod. 201044** è un **disco livellante in gomma** da posizionare sulla testa del supporto per spessorare uno o più settori e compensare piastrelle con spessori non omogenei.

EN_LEVELLING DISK FOR HEAD

The item with **cod. 201044** is a **rubber levelling disk** to be placed on the support head to shim one or more sectors and correct tiles with uneven thicknesses.

FR_DISQUE DE NIVELLEMENT POUR TÊTE

L'article avec le **cod. 201044** est un **disque de nivellement en caoutchouc** à placer sur la tête du support pour épaissir un ou plusieurs secteurs et compenser les carreaux d'épaisseurs non homogènes.

DE_NIVELLIERELEMENT FÜR DEN KOPF

Der Artikel mit der **Artikelnummer 201044** ist ein **Nivellierelement aus Gummi**, das am Kopf der Stelzlagerstütze platziert wird, um einen oder mehrere Bereiche des Kopfes aufzupolstern und damit ungleichmäßige Fliesendicken auszugleichen.



201044

DISCO LIVELLANTE PER BASE

L'articolo con **cod. 201045** è un **disco livellante in gomma** da posizionare alla base del supporto per spessorare uno o più settori e compensare eventuali imperfezioni del sottofondo.

EN_LEVELLING DISK FOR BASE

The item with **cod. 201045** is a **rubber levelling disk** to be placed under the support base to shim one or more sectors and correct any imperfections in the subfloor.

FR_DISQUE DE NIVELLEMENT POUR BASE

L'article avec le **cod. 201045** est un **disque de nivellement en caoutchouc** à placer à la base du support pour épaissir un ou plusieurs secteurs et compenser les éventuelles imperfections du substrat.

DE_NIVELLIERSCHEIBE FÜR DEN SOCKEL

Der Artikel mit der **Artikelnummer 201045** ist ein **Nivellierelement aus Gummi**, das unter dem Sockel der Stelzlagerstütze platziert wird, um einen oder mehrere Bereiche zu unterfüllen und damit vorhandene Unebenheiten des Untergrunds auszugleichen.



201045

La gamma

EN_The range
FR_La gamme
DE_Die Produktpalette

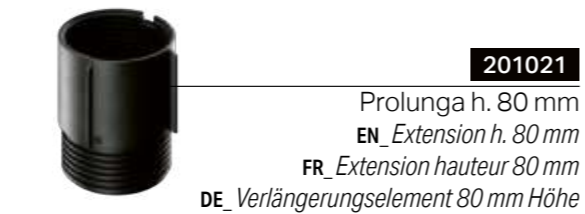

PP LEVEL DUO MAXI - base + vite PP LEVEL DUO MAXI - base + screw

| cod. | prezzo - price | descrizione - description | conf. - pack | pallet |
|---------------|----------------|--|--------------|--------|
| 201016 | € 5,30 | base + vite regolabile da h. 28 a 39 mm base + screw adjustable from h. 28 to 39 mm | 24 | 1152 |
| 201017 | € 6,40 | base + vite regolabile da h. 38 a 57 mm base + screw adjustable from h. 38 to 57 mm | 24 | 1152 |
| 201018 | € 7,40 | base + vite regolabile da h. 56 a 91 mm base + screw adjustable from h. 56 to 91 mm | 24 | 672 |
| 201019 | € 8,80 | base + vite regolabile da h. 87 a 150 mm base + screw adjustable from h. 87 to 150 mm | 24 | 480 |

no sconfezionamento - no partial packaging



PROLUNGHE PER PP LEVEL DUO MAXI EXTENSIONS FOR PP LEVEL DUO MAXI

| cod. | prezzo - price | descrizione - description | conf. - pack | pallet |
|---------------|----------------|---|--------------|--------|
| 201020 | € 2,80 | prolunga h. 10 mm extension h. 10 mm | 15 | 1800 |
| 201021 | € 4,80 | prolunga h. 80 mm extension h. 80 mm | 24 | 960 |

no sconfezionamento - no partial packaging

| | | |
|-------------------------------|---|-------------|
| 201018 + 201021 | = | 136/195 mm |
| 201019 + 201021 | = | 167/254 mm |
| 201019 + (2 × 201021) | = | 247/358 mm |
| 201019 + (3 × 201021) | = | 327/462 mm |
| 201019 + (4 × 201021) | = | 407/566 mm |
| 201019 + (5 × 201021) | = | 487/671 mm |
| 201019 + (6 × 201021) | = | 567/775 mm |
| 201019 + (7 × 201021) | = | 647/879 mm |
| 201019 + (8 × 201021) | = | 727/983 mm |
| 201019 + (9 × 201021) | = | 807/1087 mm |
| 201019 + (10 × 201021) | = | 887/1192 mm |



PP LEVEL DUO MAXI - Testa autolivellante per pavimenti in ceramica PP LEVEL DUO MAXI - Self-levelling head for ceramic floors

| cod. | prezzo - price | descrizione - description | conf. - pack | pallet |
|---------------|----------------|---|--------------|--------|
| 201022 | € 3,60 | testa fuga 2 mm head for 2 mm joints | 48 | 3840 |
| 201023 | € 3,60 | testa fuga 3 mm head for 3 mm joints | 48 | 3840 |
| 201024 | € 3,60 | testa fuga 4 mm head for 4 mm joints | 48 | 3840 |

no sconfezionamento - no partial packaging



201025

PP LEVEL MAXI FIX - **Testa fissa** per pavimenti in ceramica
PP LEVEL MAXI FIX - **Fixed head** for ceramic floors

| cod. | prezzo - price | descrizione - description | conf. - pack | pallet |
|--------|----------------|---|--------------|--------|
| 201025 | € 1,90 | Testa fissa fuga 4 mm Fixed head for 4-mm joints | 48 | 3840 |

no sconfezionamento - no partial packaging

con testa fissa **cod. 201025** le escursioni delle basi + viti sono da considerarsi inferiori di 3 mm, quindi le altezze saranno:

cod. 201016: da 25 a 36,
cod. 201017: da 35 a 54,
cod. 201018: da 53 a 88,
cod. 201019: da 84 a 147

with fixed head **cod. 201025** the ranges of the bases + screws are to be considered 3 mm lower, therefore the heights will be:

cod. 201016: from 25 to 36,
cod. 201017: from 35 to 54,
cod. 201018: from 53 to 88,
cod. 201019: from 84 to 147



201026



201027



201028



201029



201030

201031

PP LEVEL DUO MAXI - **Joist**

| cod. | prezzo - price | descrizione - description | conf. - pack | pallet |
|--------|----------------|--|--------------|--------|
| 201026 | € 4,10 | testa per travetto in alluminio head for aluminium joist | 48 | 3840 |
| 201027 | € 30,80* | travetto in alluminio naturale L. 240 cm natural aluminium joist L. 240 cm | 8 | - |
| 201028 | € 0,60 | distanziatore fuga 4 mm per travetto cod. 201027 4-mm spacer for joist cod. 201027 | 500 | - |
| 201029 | € 3,90* | gomma antirumore per travetto cod. 201027 rotolo 50 metri noise-proof rubber for joist cod. 201027 - 50 meters roll | 1 | - |
| 201030 | € 1,90* | gomma antirumore per travetto cod. 201027 rotolo 200 metri noise-proof rubber for joist cod. 201027 - 200 meters roll | 1 | - |
| 201031 | € 0,70 | giunto di raccordo per travetto cod. 201027 connection joint for joist cod. 201027 | 250 | - |

no sconfezionamento - no partial packaging

* Prezzo al metro lineare
Price per linear meter . Prix par mètre linéaire. Preis pro laufendem Meter



201032



201033

PP LEVEL MINI
Testa fuga/head 4 mm
Alette/tabs h. 10 mm

| cod. | prezzo - price | descrizione - description | conf. - pack | pallet |
|--------|----------------|--|--------------|--------|
| 201032 | € 4,00 | supporto regolabile da h. 10 a 15 mm adjustable support from h. 10 to 15 mm | 20 | - |
| 201033 | € 1,90 | prolunga h. 5 mm per articolo con cod. 201032 (max 3 prolunghe = + 15 mm) extension h. 5 mm for item with cod. 201032 (max. 3 extensions = + 15 mm) | 20 | - |

no sconfezionamento - no partial packaging



201034



201035



201036

SP Supporti
SP Supports

| cod. | prezzo - price | descrizione - description | conf. - pack | pallet |
|--------|----------------|--|--------------|--------|
| 201034 | € 0,70 | supporto ad altezza fissa diam. 155x14 h. fixed height support diam. 155 x 14 h. | 360 | 5760 |
| 201035 | € 0,70 | livellatore per supporto cod. 201034 h. 1 mm leveller for support cod. 201034 - h. 1 mm | 1000 | 20000 |
| 201036 | € 0,70 | livellatore per supporto cod. 201034 h. 3 mm leveller for support cod. 201034 - h. 3 mm | 500 | 15000 |

no sconfezionamento - no partial packaging

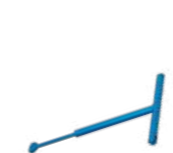

201037



201038



201039



201040



201041



201042

PP LEVEL DUO MAXI - **Accessori**
PP LEVEL DUO MAXI - **Accessories**

| cod. | prezzo - price | descrizione - description | conf. - pack | pallet |
|--------|----------------|--|--------------|--------|
| 201037 | € 61,50 | chiave di regolazione (per fughe 4 mm) adjustment key (for 4 mm joints) | 12 | - |
| 201038 | € 50,90 | inserto per trapano avvitatore insert for screwdriver drill | 1 | - |
| 201039 | € 21,10 | clip perimetrale (base + testa) perimeter clip (base + head) | 30 | - |
| 201040 | € 68,50 | clip angolare (base + testa) corner clip (base + head) | 4 | - |
| 201041 | € 6,40 | clip muro in acciaio inox wall clip in stainless steel | 50 | - |
| 201042 | € 2,00 | clip muro in PoliPropilene nero wall clip in polypropylene | 200 | - |
| 201043 | € 2,30 | tappetino in gomma diam. cm 21x0,2 sp. rubber mat diam. cm 21 x 0,2 thick. | 100 | - |
| 201044 | € 2,20 | disco livellante per testa diam. cm 12x0,2 sp. levelling disk for head diam. cm 12 x 0,2 thick. | 100 | - |
| 201045 | € 3,30 | disco livellante per base diam. cm 21x0,2 sp. levelling disk for base diam. cm 21 x 0,2 thick. | 100 | - |

no sconfezionamento (eccetto per chiave di regolazione cod. 201037)
no partial packaging (except for adjustment key cod. 201037)



201043



201044



201045



La posa a secco su erba



I nostri prodotti con spessore 20 mm nascono per integrarsi e resistere negli ambienti esterni. In presenza di un fondo di tipo erboso la posa viene eseguita a secco semplicemente appoggiando le piastrelle. L'opera può essere eseguita senza l'intervento di personale specializzato e senza l'utilizzo di colle per l'edilizia. Quest'ultima caratteristica determina il beneficio di rendere le superfici immediatamente calpestabili.

Adatta sia per giardini di abitazioni private che per ampi spazi pubblici, questo tipo di posa permette di modificare i tracciati o le pavimentazioni in qualsiasi momento riutilizzando lo stesso materiale più volte e in luoghi diversi.

EN *Dry laying on grass*

Our 20-mm thick products are designed to integrate and withstand outdoor settings.

In the case of a turf surface, the tiles are laid dry by simply placing them on the ground. The work can be carried out without the intervention of skilled personnel and without the use of tile adhesives. The latter feature results in the benefit of making the surfaces immediately walkable.

Suitable for both private gardens and large public spaces, this type of laying allows paths or paving to be changed at any time by reusing the same material several times and in different places.

FR *La pose à sec sur herbe*

Nos produits en épaisseur 20 mm sont conçus pour s'intégrer et résister dans les ambiances extérieurs.

Avec un support de type herbeux, la pose est effectuée à sec, simplement en posant les dalles, sans nécessité de faire intervenir un personnel spécialisé et sans utiliser de colles. Cette dernière caractéristique a l'avantage de permettre un passage immédiat sur les surfaces.

Cette pose convient aussi bien pour les habitations privées que pour de grands espaces publics car elle permet de changer les tracés ou les revêtements de sol à tout moment, en réutilisant le même matériel plusieurs fois et en des endroits différents.

DE *Trockenverlegung auf Rasen*

Unsere Produkte mit 20 mm Stärke eignen sich dank ihrer Flexibilität und Beständigkeit hervorragend für die Verlegung in Außenbereichen.

Auf Rasen bietet sich die Trockenverlegung an, bei der die Fliesen direkt auf dem Untergrund angeordnet werden.

Hierzu ist weder Fachpersonal noch der Rückgriff auf Baustoffe oder -kleber erforderlich.

Nach der Verlegung sind die Oberflächen sofort begehbar. Diese Art der Verlegung eignet sich sowohl für Gärten in Privatbesitz als auch für große öffentliche Bereiche; sie bietet den Vorteil, dass die Verläufe oder Bodenbeläge jederzeit geändert werden können, wobei das gleiche Material mehrmals und an verschiedenen Stellen wiederverwendet werden kann.



La posa a secco su ghiaia

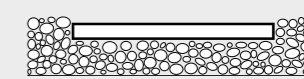

Il Progetto Outdoor presenta una serie di soluzioni per lo sviluppo di interessanti soluzioni estetiche.

Un altro sistema di posa proposto è quello su ghiaia, che si esegue semplicemente appoggiando la piastrella spessorata sopra al manto ghiaioso già steso in precedenza.

È possibile inoltre arricchire l'effetto decorativo utilizzando della ghiaia di colore o con granulometria diversa.

Il substrato di ghiaia garantisce un più facile e veloce livellamento delle piastrelle, una efficace stabilità nel tempo e il drenaggio ottimale delle acque.

La posa a secco su ghiaia è calpestabile immediatamente dopo la messa in opera e consente di modificare le pavimentazioni in qualsiasi momento.

EN *Dry laying on gravel*

The Outdoor Project offers a range of options for the development of interesting aesthetic solutions.

Another proposed laying system is on gravel, which can be done by simply placing the thicker tile on top of the previously laid gravel substrate. You can also enhance the decorative effect by using coloured gravel or with a different grain size. The gravel substrate ensures easier and faster levelling of the tiles, effective long-term stability and optimal water drainage. Dry laid tiles on gravel can be walked on immediately after installation and the paving can be modified at any time.

FR *La pose à sec sur gravier*

Le projet Outdoor présente une série de solutions pour le développement de solutions esthétiques intéressantes.

Un autre système de pose proposé est celui sur gravier: la dalle grande épaisseur est posée directement sur le gravier étalé préalablement. Il est également possible d'accentuer l'aspect décoratif en utilisant un gravier coloré ou avec des granulométries différentes. Le support en gravier garantit un nivellement plus facile et plus rapide des dalles, une stabilité dans le temps et le drainage optimale de l'eau. Les dallées posées à sec sur gravier permettent le passage immédiatement après la pose et le revêtement de sol peut être changé à tout moment.

DE *Trockenverlegung auf Kies*

Das Outdoor-Projekt bietet eine Reihe von Möglichkeiten für die Ausarbeitung interessanter ästhetischer Lösungen. Eine weitere Art der Anwendung ist die Trockenverlegung auf Kies; dabei werden die überstarken Fliesen lediglich auf der zuvor vorbereiteten Kiesschicht angeordnet. Zusätzliche dekorative Optionen können mit farbigem Kies oder verschiedenen Korngrößen in Betracht gezogen werden.

Die Unterschicht aus Kies garantiert eine leichtere und raschere Nivellierung der Fliesen, langfristige Stabilität und eine optimale Ableitung des Niederschlagswassers. Nach der Trockenverlegung auf Kies sind die Oberflächen sofort begehbar, und die Beläge können jederzeit und je nach Belieben modifiziert werden.



La posa a secco su sabbia



Le caratteristiche fisiche e tecniche dello spessore 20 mm del progetto Outdoor si adattano perfettamente in presenza di fondi sabbiosi. Tali caratteristiche possono essere particolarmente convenienti per gli stabilimenti balneari.

La superficie antiscivolo consente di realizzare pedane di servizio e camminamenti percorribili in sicurezza, **resiste al contatto prolungato con il sale e non altera l'aspetto** anche se esposta costantemente ai raggi solari. La posa si esegue a secco semplicemente appoggiando le lastre sul fondo sabbioso senza la presenza di personale specializzato. I camminamenti sono **immediatamente calpestabili** e possono essere **modificati, rimossi e riutilizzati** secondo le esigenze in qualsiasi momento.

EN_Dry laying on sand

The physical and technical features of the 20 mm thickness of the Outdoor project are perfectly suited to sandy surfaces. Such features can be particularly convenient for beach resorts. The anti-slip surface makes it possible to create safe service decks and walkways, resists prolonged contact with salt and does not alter its appearance even when constantly exposed to sunlight. The slabs are laid dry by simply placing them on the sandy bottom without the need of skilled personnel. The walkways can be immediately walked on and can be modified, removed and reused as required at any time.

FR_La pose à sec sur sable

Les caractéristiques physiques et techniques de l'épaisseur 20 mm du projet Outdoor s'adaptent parfaitement aux supports sableux. Ces caractéristiques peuvent être particulièrement avantageuses pour les établissements balnéaires. La surface anti-glissement permet de réaliser des plateformes de service et des chemins sur lesquels marcher en toute sécurité, elle résiste au contact prolongé avec le sel et son aspect ne s'altère pas même si elle est exposée en permanence à la lumière du soleil.

La pose s'effectue à sec, simplement en posant les dalles sur le sable sans nécessité de faire intervenir un personnel spécialisé. Les chemins peuvent être immédiatement empruntés et peuvent être modifiés, supprimés ou réutilisés à tout moment selon les exigences.

DE_Trockenverlegung auf Sand

Mit ihren physischen und technischen Merkmalen sind die 20 mm starken Fliesen des Outdoor-Projekts die perfekte Wahl auch bei sandigen Untergründen. Somit eignen sie sich hervorragend zur Nutzung in Badeanstalten und an Strandeinrichtungen.

Dank der rutschhemmenden Oberfläche können trittsichere Podeste für das Strandpersonal und Gehwege eingerichtet werden, und selbst der längere Kontakt mit Salz und eine ständige Sonneneinstrahlung bewirken keine Veränderungen am Aussehen des Materials.

Zur Trockenverlegung werden die Fliesen lediglich auf dem sandigen Untergrund angeordnet, ohne das hierzu Fachpersonal erforderlich ist.

Die Gehwege können unmittelbar nach der Erstellung betreten und jederzeit und je nach Anforderung geändert, entfernt und wiederverwendet werden.

Vantaggi

- **Garantisce stabilità nel tempo**
- **Ideale per superfici carrabili**
- **Sopporta le sollecitazioni del calpestio intenso**

Collocazioni Consigliate

- Cortili
- Rampe di accesso
- Garage, parcheggi
- Aree di sosta
- Piste ciclabili
- Camminamenti
- Marciapiedi
- Porticati
- Terrazzi

EN_Advantages

- Guaranteed stability over time
- Ideal for areas open to vehicle traffic
- Withstands high footfall

Recommended locations

- Courtyards
- Access ramps
- Garages, car parks
- Short-stay sites for vehicles
- Cycle paths
- Walkways
- Pavements
- Arcades/porches
- Terraces

FR_Avantages

- Stabilité garantie au fil du temps
- Idéale pour les surfaces carrossables
- Supporte les sollicitations dérivant du piétinement intense

Emplacements conseillés

- Cours
- Rampes d'accès
- Garage, parkings
- Zones de stationnement
- Pistes cyclables
- Allées
- Trottoirs
- Porches
- Terrasses

La posa a colla su massetto



Dall'abbinamento della posa a colla su massetto tradizionale con le piastrelle a spessore 20 mm è possibile creare pavimenti da outdoor con elevate prestazioni tecniche. Sono pavimentazioni caratterizzate da una perfetta stabilità del fondo e un'eccezionale resistenza ai carichi di rottura concepite per superfici sottoposte al passaggio e alla sosta di autoveicoli o per aree altamente frequentate quali marciapiedi, piste ciclabili o camminamenti pedonali.

EN_Adhesive application on screed

The combination of adhesive laying on a traditional screed with 20-mm thick tiles makes it possible to create outdoor pavings with high technical performance.

These pavements are characterised by perfect stability of the background and very high resistance to breaking loads, designed for surfaces subject to the passage and parking of motor vehicles or for areas with high traffic, such as pavements, cycle lanes or pedestrian walkways.

FR_La pose avec colle sur chape

En associant la pose collée traditionnelle sur chape avec les dalles en 20 mm d'épaisseur, il est possible de créer des sols d'extérieur offrant des performances techniques élevées.

Ces sols sont caractérisés par une stabilité parfaite du support et une exceptionnelle résistance aux charges de rupture étudiées pour des surfaces soumises au passage et au stationnement de véhicules ou pour des espaces très fréquentés comme des trottoirs, des pistes cyclables ou des chemins piétonniers.

DE_Verlegung mit Kleber auf Unterbetonblock (Estrich)

Die Verlegung mit Kleber von 20-mm-Fliesen auf einem traditionellen Unterbetonblock (Estrich) ist die ideale Ausgangssituation für Outdoor-Bodenbeläge mit ausgezeichneten technischen Performances. Neben der perfekten Stabilität des Untergrunds ist die außergewöhnliche Bruchfestigkeit ein entscheidendes Merkmal, dank dessen sich die Bodenbeläge nicht nur für Fahr- und Parkflächen von Fahrzeugen, sondern auch für stark frequentierte Bereiche wie Bürgersteige, Fahrrad- und Gehwege eignen.

DE_Vorteile

- Langzeitliche Stabilität
- Ideal für befahrene Flächen
- Beständig gegen Belastung bei intensiver Begehung

Anwendungsempfehlungen

- Höfe
- Auf- und Abfahrtsrampen
- Garagen, Parkplätze
- Halteplätze
- Fahrradwege
- Gehwege
- Bürgersteige
- Arkaden
- Terrassen

20MM R11C

I Pezzi Speciali

Il progetto Outdoor a marchio LA FABBRICA AVA si rivela uno strumento raffinato ed articolato per tutte le progettazioni di spazi esterni, anche le più articolate.

Richiedibili su richiesta, nella gamma dei nostri prodotti Outdoor è presente una serie completa di pezzi speciali ottenuti dal fondo 20 mm per rifinire piscine, giardini e, in generale, lo spazio del tuo ambiente outdoor.

EN *Trims*

LA FABBRICA AVA branded Outdoor project is a styled and articulated tool for all outdoor design projects, even the most complex ones. Our Outdoor product range includes a complete series of special pieces made from 20 mm background to finish swimming pools, gardens and, in general, your outdoor space.

All these pieces are available on request.

FR *Les pièces spéciales*

Le projet Outdoor de LA FABBRICA AVA est un outil raffiné et modulaire pour tous les projets d'espaces extérieurs, même les plus articulés. La gamme de nos produits Outdoor offre une série complète de pièces spéciales, disponibles sur demande, obtenues à partir du fond en 20 mm pour la finition de piscines, jardins et, plus généralement, de vos espaces extérieurs.

DE *Die Sonderstücke*

Das Outdoor-Projekt der Marke LA FABBRICA AVA erweist sich als raffiniertes und vielseitiges Instrument, wenn es darum geht, Außenbereiche - auch sehr komplexe - zu gestalten und einzurichten.

Auf Anfrage kann im Rahmen des Angebots unserer Outdoor-Produkte eine vollständige Serie von 20-mm-Sonderstücken für abschließende Verlegungen an Swimmingpools, in Gärten und allgemein in Außenbereichen angefordert werden.

- 1 **GRADONE COSTA RETTA**
Large step - straight edge
- 2 **GRADONE ANGOLO DX/SX COSTA RETTA**
Large step corner R-L - straight edge
- 3 **GRADONE COSTA TORO**
Large step - bullnose edge
- 4 **GRADONE ANGOLO DX/SX COSTA TORO**
Large step corner R-L - bullnose edge
- 5 **GRIGLIA**
Drainage grig
- 6 **GRIGLIA ANGOLO DX/SX COSTA TORO**
Drainage grig corner R-L
- 7 **ANGOLO CURVILINEO**
Curved shaped corner

I Pezzi Speciali

EN_ Trims

FR_ Les pièces spéciales

DE_ Die Sonderstücke

| FORMATO DELLA SERIE Main size of the series 40x120 • Amazon • Ardesia • Ca' Foscari • Dolomiti • Honey Wood • Il Cerreto | Gradone 40x120 | Gradone angolo DX/SX 40x120 | Copertina rettilinea 30x60 | Angolo curvilineo interno 40x40 - r 10 |
|--|----------------------|-----------------------------|----------------------------|--|
| | | | | |
| | | | | |
| | A: 120cm B: 40cm | A: 120cm B: 40cm | A: 60cm B: 30cm | A: 40cm B: 30cm r: 10 |
| | P211 P219 | P239 P251 | P201 | P303 P305 |
| | Griglia 20x80 | Griglia angolo DX/SX 20x80 | Griglia 20x60 | Griglia angolo DX/SX 20x60 |
| | | | | |
| | | | | |
| A: 80cm B: 20cm | A: 80cm B: 20cm | A: 60cm B: 20cm | A: 60cm B: 20cm r: 10 | |

| FORMATO DELLA SERIE Main size of the series 100x100 • Chianca • Hurban • Pierres des Châteaux • Royal Stone • Skyline | Gradone 50x100 | Gradone angolo DX/SX 50x100 | Copertina rettilinea 30x100 | Angolo curvilineo interno 50x50 - r 10 |
|--|----------------------------|-----------------------------|-----------------------------|--|
| | | | | |
| | | | | |
| | A: 100cm B: 50cm | A: 100cm B: 50cm | A: 100cm B: 30cm | A: 50cm B: 50cm r: 10 |
| | P225 P235 | P245 P253 | P303 | P337 P311 |
| | Angolo curvilineo 100x100 | Angolo curvilineo 100x100 | Griglia 20x100 | Griglia angolo DX/SX 20x100 |
| | | | | |
| | | | | |
| A: 100cm B: 50cm r: 15 | A: 100cm B: 50cm r: 30 | A: 100cm B: 20cm | A: 100cm B: 20cm | |
| P423 P423 | P423 P423 | - | - | |

A disposizione solo su richiesta. Tempi di consegna: 30gg
 Available upon request only. Delivery terms: 30 days
 Disponible seulement sur requête. Délais de livraison: 30 jours
 Verfügbar auf Anfrage. Lieferzeit: 30 Tage

I pezzi speciali H2o sono realizzati con un bordo smaltato resistente per esterni.

EN_ H2O trims are made with a durable glazed edge suitable for outdoor use.

FR_ Les pièces spéciales en H2O sont fabriquées avec un bord émaillé résistant pour une utilisation en extérieur.

DE_ Die speziellen H2O-Stücke sind mit einem widerstandsfähigen glasierten Rand für den Außenbereich hergestellt.



| FORMATO DELLA SERIE Main size of the series 80x80 • Agglomerate • Ardesia • Blue Evolution • Space • Storm | Gradone 40x80 | Gradone angolo DX/SX 40x80 | Copertina rettilinea 30x80 | Angolo curvilineo interno 40x40 - r 10 |
|---|-------------------------|----------------------------|----------------------------|--|
| | | | | |
| | | | | |
| | A: 80cm B: 40cm | A: 80cm B: 40cm | A: 80cm B: 30cm | A: 40cm B: 40cm r: 10 |
| | P175 P181 | P197 P203 | P275 | P303 P311 |
| | Angolo curvilineo 80x80 | Griglia 20x80 | Griglia angolo DX/SX 20x80 | |
| | | | | |
| | | | | |
| A: 80cm B: 40cm r: 15 | A: 80cm B: 20cm | A: 80cm B: 20cm | | |
| P423 P423 | - | - | | |













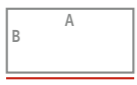
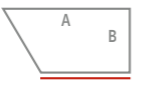





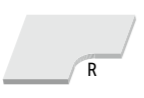

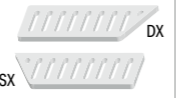
A disposizione solo su richiesta. Tempi di consegna: 30gg
 Available upon request only. Delivery terms: 30 days
 Disponible seulement sur requête. Délais de livraison: 30 jours
 Verfügbar auf Anfrage. Lieferzeit: 30 Tage

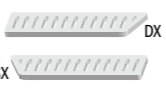
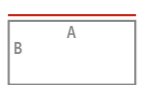
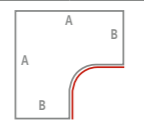

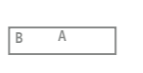





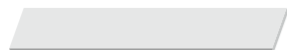

I Pezzi Speciali

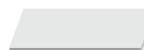
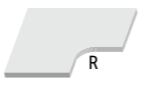
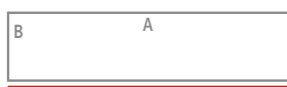
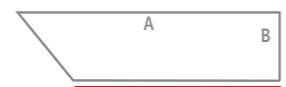
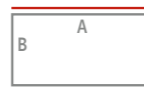
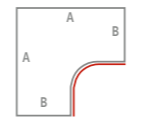
EN_Trims

FR_Les pièces spéciales

DE_Die Sonderstücke

| FORMATO DELLA SERIE Main size of the series 60x60 • I Quarzi • Royal Stone • Storm | Gradone 30x60  | | Gradone angolo DX/SX 30x60  | | | |
|---|--|--|--|--|--|--|
| |  | |  | | | |
| | A: 60cm B: 30cm | | A: 60cm B: 30cm | | | |
| |  | P135 |  | P145 | | |
| |  | P135 |  | P151 | | |
| | Copertina rettilinea 30x60  | Angolo curvilineo 60x60 - r 15  | Griglia 30x60  | Griglia angolo DX/SX 30x60  | Griglia 15x60  | Griglia angolo DX/SX 15x60  |
| |  |  |  |  |  |  |
| | A: 60cm B: 30cm | A: 60cm B: 30cm r:15 | A: 60cm B: 30cm | A: 60cm B: 30cm | A: 60cm B: 15cm | A: 60cm B: 15cm |
| |  | P197 |  | P319 | - | - |
| |  | P319 |  | P319 | - | - |

| FORMATO DELLA SERIE Main size of the series 60x120 • Noble Stone • Velaris | Gradone 30x120  | | Gradone angolo DX/SX 30x120  | | Copertina rettilinea 30x60  | | Angolo curvilineo 60x60 - r 15  | |
|--|--|------|---|------|---|------|--|------|
| |  | |  | |  | |  | |
| | A: 120cm B: 30cm | | A: 120cm B: 30cm | | A: 60cm B: 30cm | | A: 60cm B: 30cm r: 10 | |
| |  | P215 |  | P239 |  | P211 |  | P319 |
| |  | P221 |  | P251 |  | |  | P319 |

I pezzi speciali H2o sono realizzati con un bordo smaltato resistente per esterni.

H2O trims are made with a durable glazed edge suitable for outdoor use.

Les pièces spéciales en H2O sont fabriquées avec un bord émaillé résistant pour une utilisation en extérieur.

Die speziellen H2O-Stücke sind mit einem widerstandsfähigen glasierten Rand für den Außenbereich hergestellt.

A disposizione solo su richiesta. Tempi di consegna: 30gg

Available upon request only. Delivery terms: 30 days

Disponible seulement sur requête. Délais de livraison: 30 jours

Verfügbar auf Anfrage. Lieferzeit: 30 Tage

GRIGLIA
Drainage grid

GRADONE
Large step

GRIGLIA ANGOLO DESTRO E SINISTRO
Drainage grid - corner L/R

GRADONE ANGOLO DESTRO E SINISTRO
Large Step - corner L/R

GRADONE
Large Step

Imballi Lastre

Slabs Packaging

Paletta Pallet



INGOMBRO - SIZE: 120x80x14,4 CM
TARA - TARE: 22 KG

Tiles dimension
20x120 | 30x120 | 40x120
30x60 | 60x60 | 60x120
20x40 | 40x40 | 40x60 | 40x80
10x30 | 6,1x37



INGOMBRO - SIZE: 120x96x13,6 CM
TARA - TARE: 20 KG

Tiles dimension
60x120 Lapp



INGOMBRO - SIZE: 152x77,6x16,1 CM
TARA - TARE: 20 KG

Tiles dimension
23,4x148

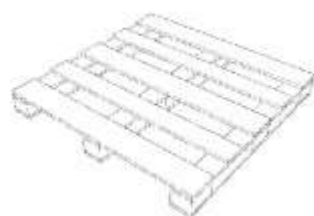

INGOMBRO - SIZE: 103x123x14,4 CM
TARA - TARE: 30 KG
Tiles dimension
60x100 h20



INGOMBRO - SIZE: 103x103x13,9 CM
TARA - TARE: 22 KG
Tiles dimension
100x100 h20

Pallet con sponde Pallet with sides

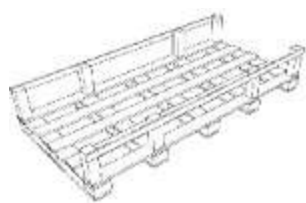

INGOMBRO - SIZE: 184x97x45 CM
TARA - TARE: 36 KG

cod. 202019

Tiles dimension
80x180 | 40 pieces



INGOMBRO - SIZE: 168x97x40,9 CM
TARA - TARE: 29,4 KG

cod. 202017

Tiles dimension
80x160 | 30 pieces



INGOMBRO - SIZE: 122x137x74 CM
TARA - TARE: 29 KG

cod. 202015

Tiles dimension
120x120 | 48 pieces

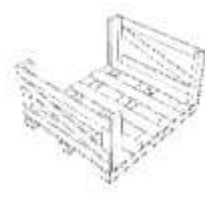

INGOMBRO - SIZE: 103x123x74 CM
TARA - TARE: 26 KG

cod. 202014

Tiles dimension
100x100 | 48 pieces

Imballi Packaging

Cavalletti A-frame



WOOD A-FRAME

INGOMBRO - SIZE: 330x75x193,5 CM
TARA - TARE: 177,50 KG

cod. 202011

Tiles dimension
324x163 | 22 pieces
320x160 | 44 pieces
160x160 | 88 pieces

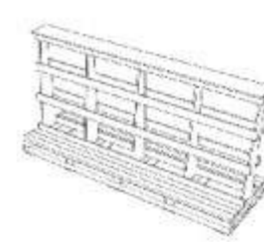

WOOD A-FRAME

INGOMBRO - SIZE: 290x75x161 CM
TARA - TARE: 145 KG

cod. 202009

Tiles dimension
280x120 | 44 pieces
120x120 | 88 pieces



WOOD A-FRAME

INGOMBRO - SIZE: 250x75x161 CM
TARA - TARE: 132 KG

cod. 202010

Tiles dimension
240x120 | 44 pieces
120x120 | 88 pieces



IRON A-FRAME

INGOMBRO - SIZE: 330x75x193,5 CM
TARA - TARE: 130 KG

cod. 202012

Tiles dimension
324x163 | 22 pieces

Cassa in legno Wood crate



INGOMBRO - SIZE: 345x175x37 CM
TARA - TARE: 140 KG

cod. 202002

Tiles dimension
163x324 | 10 pieces
160x320 | 14 pieces



INGOMBRO - SIZE: 292x145x35 CM
TARA - TARE: 108 KG

cod. 202005

Tiles dimension
120x280 | 20 pieces



INGOMBRO - SIZE: 264x136x40 CM
TARA - TARE: 100 KG

cod. 202001

Tiles dimension
120x240 | 20 pieces



INGOMBRO - SIZE: 182,6x173,6x40,4 CM
TARA - TARE: 80 KG

cod. 202003

Tiles dimension
160x160 | 24 pieces

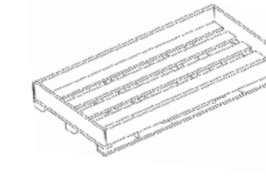

INGOMBRO - SIZE: 252x94x30,4 CM
TARA - TARE: 85 KG

cod. 202006

Tiles dimension
24x240 | 54 pieces
40x240 | 36 pieces

Caratteristiche tecniche

EN Technical features

FR Caractéristiques techniques

DE Technische eigenschaften

Classificazione secondo UNI EN 14411 - ISO 13006 - G - Bla (E ≤ 0,5%) UGL

Product in compliance with UNI EN 14411 - ISO 13006 - G - Bla (E ≤ 0,5%) UGL

Classement selon UNI EN 14411 - ISO 13006 - G - Bla (E ≤ 0,5%) UGL











Klassifizierung nach UNI EN 14411 - ISO 13006 - G - Bla (E ≤ 0,5%) UGL

GRES PORCELLANATO

Porcelain tiles

Grès cérame

Feinsteinzeug

| | CARATTERISTICA SPECIFICATION CARACTERISTIQUE EIGENSCHAFT | METODO DI PROVA TEST METHODS METHODE D'ESSAI TESTVERFAHREN | VALORE PRESCRITTO FIXED VALUE VALEUR PRESCRITE VORGESCHRIEBENER WERT | | |
|---|---|---|--|---|--|
|  | CARATTERISTICHE DIMENSIONALI DIMENSIONS AND SURFACE QUALITY DIMENSIONS DIMENSIONALE EIGENSCHAFTEN | ISO 10545-2 | LUNGHEZZA E LARGHEZZA LENGTH AND WIDTH. LONGUEUR ET LARGEUR. LÄNGE UND BREITE | ±0.6% or ±2mm | CONFORME COMPLIANT CONFORME ERFÜLLT |
| | | | SPESSORE THICKNESS. EPAISSEUR. STÄRKE | ±5% | |
| | | | RETTILINEITÀ STRAIGHTNESS OF SIDES. RECTITUDE DES BORDS RECHTECKIGKEIT DER ECKEN | ±0.5% | |
| | | | ORTOGONALITÀ. RECTANGULARITY. ORTHOGONALITÉ. RECHTWINKLIGKEIT | ±0.5% | |
| | | | PLANARITÀ SURFACE FLATNESS. PLANEITUDE EBENFLÄCHIGKEIT | ±0.5% | |
| | | | 95% DELLE PIASTRELLE ESENTI DA DIFETTI VISIBILI 95% OF TILES SHOW NO VISIBLE DEFECTS 95% DES CARREAUX SONT DÉPOURVUS DE DÉFAUTS VISIBLES 95% DER FLIESEN SIND FREI VON SICHTBAREN FEHLERN | | |
|  | ASSORBIMENTO D'ACQUA WATER ABSORPTION ABSORTION D'EAU WASSERAUFNAHME | ISO 10545-3 | ≤ 0,5 % | CONFORME COMPLIANT CONFORME ERFÜLLT | |
|  | RESISTENZA ALLA FLESSIONE BREAKING MODULUS RESISTANCE A LA FLEXION BIEGEFESTIGKEIT | ISO 10545-4 | ≥ 35 N/mm ² | CONFORME COMPLIANT CONFORME ERFÜLLT | |
| | SFORZO DI ROTTURA MODULUS OF RUPTURE CHARGE DE RUPTURE BRUCHLAST | ISO 10545-4 | ≥ 7,5 mm = ≥ 1300 N < 7,5 mm = ≥ 700 N | CONFORME COMPLIANT CONFORME ERFÜLLT | |
|  | RESISTENZA ALLA ABRASIONE PROFONDA DEEP ABRASION RESISTANCE RESISTANCE A L'ABRASION PROFONDE BESTÄNDIGKEIT GEGEN TIEFENVERSCHLEISS | ISO 10545-6 | ≤ 175 mm ³ | CONFORME COMPLIANT CONFORME ERFÜLLT | |
|  | COEFFICIENTE DI DILATAZIONE TERMICA LINEARE THERMAL EXPANSION COEFFICIENT COEFFICIENT DE DILATATION THERMIQUE LINEAIRE WARMEAUSDEHNUNGSKOEFFIZIENT | ISO 10545-8 | METODO DISPONIBILE AVAILABLE ON REQUEST METHODE DISPONIBLE VERFÜGBARES VERFAHREN | ≤ 7x10 ⁻⁶ °C ⁻¹ | |
|  | RESISTENZA AGLI SBALZI TERMICI THERMAL SHOCK RESISTANCE RESISTANCE AUX ECARTS DE TEMPERATURE TEMPERATURWECHSELBESTÄNDIGKEIT | ISO 10545-9 | METODO DISPONIBILE AVAILABLE ON REQUEST METHODE DISPONIBLE VERFÜGBARES VERFAHREN | RESISTENTI RESISTANT RÉSISTANTS WIDERSTANDSFAHIG | |
|  | RESISTENZA AL GELO FROST RESISTANCE RESISTANCE AU GEL FROSTBESTÄNDIGKEIT | ISO 10545-12 | RICHIESTA ALWAYS TESTED EXIGEE NOTWENDIG | RESISTENTI RESISTANT RÉSISTANTS WIDERSTANDSFAHIG | |
|  | PRODOTTI CHIMICI AD USO DOMESTICO ED ADDITIVI PER PISCINA HOUSEHOLD CHEMICALS AND SWIMMING POOL WATER CLEANSERS PRODUITS CHIMIQUES COURANTS ET ADDITIFS POUR PISCINE CHEM. PRODUKTE FÜR DEN HAUSHALTSGEBRAUCH UND ZUSATZ FÜR SCHWIMMBÄDER | ISO 10545-13 | METODO DISPONIBILE AVAILABLE ON REQUEST METHODE DISPONIBLE VERFÜGBARES VERFAHREN | CONFORME COMPLIANT CONFORME ERFÜLLT | |
| | ACIDI ED ALCALI A BASSA CONCENTRAZIONE ACIDS AND LOW CONCENTRATION ALKALIS ACIDES ET ALCALI A FAIBLE CONCENTRATION SÄUREN UND ALKALI IN GERINGER KONZENTRATION | | COME DICHIARATO DAL PRODUTTORE AS DECLARED BY THE MANUFACTURER COMME LE DÉCLARE LE PRODUCTEUR WIE VOM HERSTELLER ERKLÄRT | RESISTENTI RESISTANT RÉSISTANTS WIDERSTANDSFAHIG | |
| | ACIDI ED ALCALI AD ALTA CONCENTRAZIONE. ACIDS AND HIGH CONCENTRATION ALKALIS ACIDES ET ALCALI A FORTE CONCENTRATION. SÄUREN UND ALKALI IN HOHER KONZENTRATION | | METODO DISPONIBILE. AVAILABLE ON REQUEST METHODE DISPONIBLE. VERFÜGBARES VERFAHREN | RESISTENTI. RESISTANT RÉSISTANTS. WIDERSTANDSFAHIG | |
|  | RESISTENZA ALLE MACCHIE STAIN RESISTANCE RESISTANCE AUX TACHES FLECKBESTÄNDIGKEIT | ISO 10545-14 | METODO DISPONIBILE AVAILABLE ON REQUEST METHODE DISPONIBLE VERFÜGBARES VERFAHREN | RESISTENTI RESISTANT RÉSISTANTS WIDERSTANDSFAHIG | |
|  | STABILITÀ DEI COLORI ALLA LUCE COLOUR STABILITY TO LIGHT STABILITÉ DES COULEURS A LA LUMIÈRE LICHTECHTHEIT DER FARBEN | DIN 51094 | METODO DISPONIBILE AVAILABLE ON REQUEST METHODE DISPONIBLE VERFÜGBARES VERFAHREN | CONFORME COMPLIANT CONFORME ERFÜLLT | |
|  | COEFFICIENTE DI ATTRITO (SCIVOLOSITÀ) FRICTION COEFFICIENT (SLIPPERINESS) COEFFICIENT DE FROTTEMENT (GLISSANCE) REIBUNGSKOEFFIZIENT (GLÄTTE) | ENI6165 ANNEX B (DIN 51130) | DOVE RICHIESTO IF NEEDED SI DEMANDE NACH ANFORDERUNG | A RICHIESTA AVAILABLE ON REQUEST SUR DEMANDE AUF ANFRAGE | |
| | | ENI6165 ANNEX A (DIN 51097) | | | |
| | | D.M. 236/89 | | | |
| | | B.C.R. | | | |
| | | ANSI A 326.3:2021 | | | |

Classificazione secondo UNI EN 14411 - ISO 13006 - G - Bla (E ≤ 0,5%) GL

Product in compliance with UNI EN 14411 - ISO 13006 - G - Bla (E ≤ 0,5%) GL

Classement selon UNI EN 14411 - ISO 13006 - G - Bla (E ≤ 0,5%) GL











Klassifizierung nach UNI EN 14411 - ISO 13006 - G - Bla (E ≤ 0,5%) GL

GRES PORCELLANATO

Porcelain tiles

Grès cérame

Feinsteinzeug

| | CARATTERISTICA SPECIFICATION CARACTERISTIQUE EIGENSCHAFT | METODO DI PROVA TEST METHODS METHODE D'ESSAI TESTVERFAHREN | VALORE PRESCRITTO FIXED VALUE VALEUR PRESCRITE VORGESCHRIEBENER WERT | | |
|---|--|---|--|---|--|
|  | CARATTERISTICHE DIMENSIONALI DIMENSIONS AND SURFACE QUALITY DIMENSIONS DIMENSIONALE EIGENSCHAFTEN | ISO 10545-2 | LUNGHEZZA E LARGHEZZA LENGTH AND WIDTH. LONGUEUR ET LARGEUR. LÄNGE UND BREITE | ±0.6% or ±2mm | CONFORME COMPLIANT CONFORME ERFÜLLT |
| | | | SPESSORE THICKNESS. EPAISSEUR. STÄRKE | ±5% | |
| | | | RETTILINEITÀ STRAIGHTNESS OF SIDES. RECTITUDE DES BORDS RECHTECKIGKEIT DER ECKEN | ±0.5% | |
| | | | ORTOGONALITÀ. RECTANGULARITY. ORTHOGONALITÉ. RECHTWINKLIGKEIT | ±0.5% | |
| | | | PLANARITÀ SURFACE FLATNESS. PLANEITUDE EBENFLÄCHIGKEIT | ±0.5% | |
| | | | 95% DELLE PIASTRELLE ESENTI DA DIFETTI VISIBILI 95% OF TILES SHOW NO VISIBLE DEFECTS 95% DES CARREAUX SONT DÉPOURVUS DE DÉFAUTS VISIBLES 95% DER FLIESEN SIND FREI VON SICHTBAREN FEHLERN | | |
|  | ASSORBIMENTO D'ACQUA WATER ABSORPTION ABSORTION D'EAU WASSERAUFNAHME | ISO 10545-3 | ≤ 0,5 % | CONFORME COMPLIANT CONFORME ERFÜLLT | |
|  | RESISTENZA ALLA FLESSIONE BREAKING MODULUS RESISTANCE A LA FLEXION BIEGEFESTIGKEIT | ISO 10545-4 | ≥ 35 N/mm ² | CONFORME COMPLIANT CONFORME ERFÜLLT | |
| | SFORZO DI ROTTURA MODULUS OF RUPTURE CHARGE DE RUPTURE BRUCHLAST | ISO 10545-4 | ≥ 7,5 mm = ≥ 1300 N < 7,5 mm = ≥ 700 N | CONFORME COMPLIANT CONFORME ERFÜLLT | |
|  | RESISTENZA ALLA ABRASIONE DELLA SUPERFICIE DI PIASTRELLE SMALTATE RESISTANCE TO SURFACE ABRASION OF GLAZED TILES RÉSISTANCE À L'ABRASION DE LA SURFACE DES CARREAUX ÉMAILLÉS WIDERSTAND GEGEN ABRIBRE DER OBERFLÄCHE DER GLASIERTEN FLIESEN | ISO 10545-7 | CLASSI 0-5 | SECONDO QUANTO DICHIARATO AS DECLARED SUivant LES DÉCLARATIONS GEMÄSS DEN ANGABEN | |
|  | COEFFICIENTE DI DILATAZIONE TERMICA LINEARE THERMAL EXPANSION COEFFICIENT COEFFICIENT DE DILATATION THERMIQUE LINEAIRE WARMEAUSDEHNUNGSKOEFFIZIENT | ISO 10545-8 | METODO DISPONIBILE AVAILABLE ON REQUEST METHODE DISPONIBLE VERFÜGBARES VERFAHREN | ≤ 7x10 ⁻⁶ °C ⁻¹ | |
|  | RESISTENZA AGLI SBALZI TERMICI THERMAL SHOCK RESISTANCE RESISTANCE AUX ECARTS DE TEMPERATURE TEMPERATURWECHSELBESTÄNDIGKEIT | ISO 10545-9 | METODO DISPONIBILE AVAILABLE ON REQUEST METHODE DISPONIBLE VERFÜGBARES VERFAHREN | RESISTENTI RESISTANT RÉSISTANTS WIDERSTANDSFAHIG | |
|  | RESISTENZA AL GELO FROST RESISTANCE RESISTANCE AU GEL FROSTBESTÄNDIGKEIT | ISO 10545-12 | RICHIESTA ALWAYS TESTED EXIGEE NOTWENDIG | RESISTENTI RESISTANT RÉSISTANTS WIDERSTANDSFAHIG | |
|  | PRODOTTI CHIMICI AD USO DOMESTICO ED ADDITIVI PER PISCINA HOUSEHOLD CHEMICALS AND SWIMMING POOL WATER CLEANSERS PRODUITS CHIMIQUES COURANTS ET ADDITIFS POUR PISCINE CHEM. PRODUKTE FÜR DEN HAUSHALTSGEBRAUCH UND ZUSATZ FÜR SCHWIMMBÄDER | ISO 10545-13 | METODO DISPONIBILE AVAILABLE ON REQUEST METHODE DISPONIBLE VERFÜGBARES VERFAHREN | CONFORME COMPLIANT CONFORME ERFÜLLT | |
| | ACIDI ED ALCALI A BASSA CONCENTRAZIONE ACIDS AND LOW CONCENTRATION ALKALIS ACIDES ET ALCALI A FAIBLE CONCENTRATION SÄUREN UND ALKALI IN GERINGER KONZENTRATION | | COME DICHIARATO DAL PRODUTTORE AS DECLARED BY THE MANUFACTURER COMME LE DÉCLARE LE PRODUCTEUR WIE VOM HERSTELLER ERKLÄRT | RESISTENTI RESISTANT RÉSISTANTS WIDERSTANDSFAHIG | |
| | ACIDI ED ALCALI AD ALTA CONCENTRAZIONE. ACIDS AND HIGH CONCENTRATION ALKALIS ACIDES ET ALCALI A FORTE CONCENTRATION. SÄUREN UND ALKALI IN HOHER KONZENTRATION | | METODO DISPONIBILE. AVAILABLE ON REQUEST METHODE DISPONIBLE. VERFÜGBARES VERFAHREN | RESISTENTI. RESISTANT RÉSISTANTS. WIDERSTANDSFAHIG | |
|  | RESISTENZA ALLE MACCHIE STAIN RESISTANCE RESISTANCE AUX TACHES FLECKBESTÄNDIGKEIT | ISO 10545-14 | METODO DISPONIBILE AVAILABLE ON REQUEST METHODE DISPONIBLE VERFÜGBARES VERFAHREN | RESISTENTI RESISTANT RÉSISTANTS WIDERSTANDSFAHIG | |
|  | STABILITÀ DEI COLORI ALLA LUCE COLOUR STABILITY TO LIGHT STABILITÉ DES COULEURS A LA LUMIÈRE LICHTECHTHEIT DER FARBEN | DIN 51094 | METODO DISPONIBILE AVAILABLE ON REQUEST METHODE DISPONIBLE VERFÜGBARES VERFAHREN | CONFORME COMPLIANT CONFORME ERFÜLLT | |
|  | COEFFICIENTE DI ATTRITO (SCIVOLOSITÀ) FRICTION COEFFICIENT (SLIPPERINESS) COEFFICIENT DE FROTTEMENT (GLISSANCE) REIBUNGSKOEFFIZIENT (GLÄTTE) | ENI6165 ANNEX B (DIN 51130) | DOVE RICHIESTO IF NEEDED SI DEMANDE NACH ANFORDERUNG | A RICHIESTA AVAILABLE ON REQUEST SUR DEMANDE AUF ANFRAGE | |
| | | ENI6165 ANNEX A (DIN 51097) | | | |
| | | D.M. 236/89 | | | |
| | | B.C.R. | | | |
| | | ANSI A 326.3:2021 | | | |

Caratteristiche tecniche

EN *Technical features*
FR *Caracteristiques techniques*
DE *Technische eigenschaften*

Classificazione secondo UNI EN 14411 - ISO 13006 B IIIa

Product in compliance with UNI EN 14411 - ISO 13006 B IIIa
Classement selon UNI EN 14411 - ISO 13006 B IIIa
Klassifizierung nach UNI EN 14411 - ISO 13006 B IIIa

PASTA BIANCA - RIVESTIMENTO

White body - wall tiles
Pâte blanche - pour revêtement
Weißscherbügel - Für wandbelag

| | CARATTERISTICA SPECIFICATION CARACTERISTIQUE EIGENSCHAFT | METODO DI PROVA TEST METHODS METHODE D'ESSAI TESTVERFAHREN | VALORE PRESCRITTO FIXED VALUE VALEUR PRESCRITE VORGESCHRIEBENER WERT | UNITÀ DI MISURA UNIT OF MEASUREMENT UNITÉ DE MESURE MASSEINHEIT | |
|--|--|---|---|--|--|
| | DIMENSIONE LATI DIMENSIONS - LENGTH AND WIDTH DIMENSIONS - LONGUEUR ET LARGEUR LÄNGE UND BREITE | UNI EN ISO 10545-2 | ± 0,5 | % | |
| | RETTILINEITÀ DEI LATI SIDES' STRAIGHTNESS RECTITUDE DES CÔTES GERADLINIGKEIT DER KANTEN | | ± 0,3 | % | |
| | ORTOGONALITÀ DEI LATI SIDES' RECTANGULARITY OCTOGONALITÉ DES CÔTES RECHTWINKLIGKEIT DER KANTEN | | ± 0,5 | % | |
| | PLANARITÀ FLATNESS PLANEITUDE EBENFLÄCHIGKEIT | | ± 0,5 | % | |
| | SPESSORE THICKNESS ÉPAISSEUR STÄRKE | | ± 10 | % | |
| | ASSORBIMENTO D'ACQUA WATER ABSORPTION ABSORPTION D'EAU WASSERAUFNAHME | UNI EN ISO 10545-3 | > 10 | % | CONFORME. COMPLIANT CONFORME. ERFÜLLT |
| | SFORZO DI ROTTURA MODULUS OF RUPTURE CHARGE DE RUPTURE BRUCHLAST | UNI EN ISO 10545-4 | ≥ 600 SE SPESSE ≥ 7,5 MM. ≥ 200 SE SPESSE < 7,5 MM. | N | CONFORME. COMPLIANT CONFORME. ERFÜLLT |
| | RESISTENZA ALLA FLESSIONE BREAKING MODULUS RESISTANCE A LA FLEXION BIEGEFESTIGKEIT | | ≥ 15 SE SPESSE < 7,5 mm. ≥ 12 SE SPESSE ≥ 7,5 mm. | N/mm ² | CONFORME. COMPLIANT CONFORME. ERFÜLLT |
| | COEFFICIENTE DI DILATAZIONE TERMICA LINEARE THERMAL EXPANSION COEFFICIENT COEFFICIENT DE DILATATION THERMIQUE LINEAIRE WÄRMEAUDEHNUNGSKOEFFIZIENT | UNI EN ISO 10545-8 | METODO DISPONIBILE AVAILABLE ON REQUEST METHODE DISPONIBLE VERFÜGBARES VERFAHREN | *MK (-1) | 7,00 |
| | RESISTENZA AGLI SBALZI TERMICI THERMAL SHOCK RESISTANCE RESISTANCE AUX ECARTS DE TEMPERATURE. TEMPERATURWECHSELBESTÄNDIGKEIT | UNI EN ISO 10545-9 | METODO DISPONIBILE AVAILABLE ON REQUEST METHODE DISPONIBLE VERFÜGBARES VERFAHREN | | RESISTENTI. RESISTANT RÉSISTANTS. WIDERSTANDSFAHIG |
| | RESISTENZA AL CAVILLO CRAZING RESISTANT RÉSISTANCE AUX TRÉSSAILLURES HAARRISSE | UNI EN ISO 10545-11 | RICHIESTA. ALWAYS TESTED EXIGEE. NOTWENDIG | | RESISTENTI. RESISTANT RÉSISTANTS. WIDERSTANDSFAHIG |
| | RESISTENZA ALLE MACCHIE STAIN RESISTANCE RÉSISTANCE AUX TACHES FLECKBESTÄNDIGKEIT | UNI EN ISO 10545-14 | 3 MIN | | 4-5 |
| | RESISTENZA ALL'ATTACCO CHIMICO CHEMICAL RESISTANCE RÉSISTANCE AUX PRODUITS CHIMIQUES BESTÄNDIGKEIT GEBIEN CHEMIKALIEN | UNI EN ISO 10545-13 | GBMIN | | CONFORME. COMPLIANT CONFORME. ERFÜLLT |
| | RESISTENZA AGLI ACIDI E ALLE BASI A BASSA CONCENTRAZIONE RESISTANT TO ACID AND LOW CONCENTRATION BASES RESISTANCE AUX ACIDES ET AUX BASES À FAIBLE CONCENTRATION WIDERSTANDSFÄHIGKEIT GEGENUBER NIEDRIG KONZENTRIERTEN SÄUREN UND LAUGEN | | METODO DISPONIBILE AVAILABLE ON REQUEST METHODE DISPONIBLE VERFÜGBARES VERFAHREN | ≥ GLB | |
| | RESISTENZA ALL'ABRAZIONE RESISTANCE TO ABRASION RÉSISTANCE À L'ABRASION BESTÄNDIGKEIT GEGEN OBERFLÄCHENVERSCHLEISS | UNI EN ISO 10545-7 | CLASSE 1-5 CLASS 1-5 CLASSE 1-5 KLASSE 1-5 | | 2-5 |

Certificazioni

EN *Certifications*
FR *Certifications*
DE *Zertifizierungen*

100% DESIGN
AND PRODUCTION
OF ITALY

Ceramics of Italy



Tutte le piastrelle sono certificabili MOCA.
All the tiles can be MOCA-certified.
Toutes les carreaux sont certifiées MOCA.
Alle Bodenfliesen sind nach MOCA
zertifizierbar.



DOLOMITI, I QUARZI, KAURI
LASCAUX, SPACE, STORM, SKYLINE



IT7021/015

I QUARZI



Attestazione della percentuale di riciclato, Dichiarazione Ambientale di prodotto settoriale, UPEC, Marchio CCC, Marcatura CE, Certificazione VOC-COV, Conformità Bielorussia, Conformità Egitto ES 3168-2/2015
Certificate of percentage of recycled material, Industry-specific Environmental Product Declaration, UPEC, CCC mark, CE marking, VOC certification, Compliance for Byelorussia, Compliance for Egypt ES 3168-2/2015
Attestation du pourcentage de matériel recyclé, Déclaration environnementale de produit sectoriel, UPEC, Label CCC, Marquage CE, certification VOC-COV, conformité Biélorussie, conformité Égypte ES 3168-2/2015
Bescheinigung des Anteils von Recycling-Produkten, Umweltschutz-Erklärung der Produkte nach Bereichen, UPEC, CCC-Kennzeichnung, CE-Kennzeichnung, VOC-COV-Zertifizierung, Konformität für Weißrussland, Ägypten ES 3168-2/2015

Certificazioni Ambientali

Italcer S.p.A. SB adotta e mantiene attivo un processo sistematico di verifica, misura e monitoraggio delle performance dei suoi processi ambientali, che assicura il rispetto dei requisiti cogenti, consente di riesaminare lo stato della gestione e permette di intervenire con le adeguate azioni correttive e preventive per superare le criticità individuate. L'adozione di un Sistema di Gestione Ambientale certificato conforme allo standard ISO 14001 ed al Regolamento EMAS, di un Sistema di Gestione per l'Energia e di altri standard ambientali costituiscono tappe significative di un percorso di crescita attraverso il quale vogliamo dare il nostro contributo ad uno Sviluppo Sostenibile e ad un dialogo trasparente e costruttivo con le Parti Interessate.

EN_Environmental Certifications

Italcer S.p.A. SB applies and updates a systematic performance check, measurement and monitoring process for its environmental processes, which ensures respect for binding requirements, enables it to review the management status and apply the suitable corrective and preventive actions to overcome any critical points identified.

The adoption of a certified Environmental Management System compliant with the ISO 14001 standard and the EMAS Regulation, an Energy Management System and other environmental standards constitute significant steps on a path of growth, whereby we strive to provide our contribution to Sustainable Development and transparent and constructive dialogue with the Relevant Parties.

| CERTIFICAZIONE - CERTIFICATION CERTIFICATION - BESCHEINIGUNG | NUMERO - NUMBER NOMBRE - ZAHL | DESCRIZIONE / DESCRIPTION / DESCRIPTION / BESCHREIBUNG |
|--|--|--|
|  | DT 55 P1059 del 21/10/2008 | <p>Italcer S.p.A. SB è associata al Green Building Council Italia, organismo indipendente che ha come obiettivo la diffusione di una cultura dell'edilizia sostenibile ed in particolare la promozione del sistema di certificazioni LEED (Leadership in Energy and Environmental Design). I prodotti di LA FABBRICA AVA contengono percentuali di materia prima riciclata superiori anche al 50%, consentendo ai loro utilizzatori di accedere all'ottenimento di crediti LEED. Per saperne di più visita il sito www.gbctalia.org.</p> <p>EN_ Italcer S.p.A. SB is associated with Green Building Council Italia, an independent body whose goal is to promote a culture of sustainable building construction and in particular the promotion of the LEED (Leadership in Energy and Environmental Design) certification system. LA FABBRICA AVA products contain recycled raw materials even in excess of 50%, allowing their users to obtain LEED credits. To find out more visit www.gbctalia.org.</p> |
|  | EMAS Eco-Management and Audit Scheme IT 000907 del 16/5/2008 | <p>Eco-Management and Audit Scheme (EMAS) è uno strumento volontario creato dalla Comunità Europea al quale possono aderire volontariamente le aziende per valutare e migliorare le proprie prestazioni ambientali, fornendo al pubblico e ad altri soggetti interessati informazioni sulla propria gestione ambientale. Scopo prioritario dell'EMAS è contribuire alla realizzazione di uno sviluppo economico sostenibile, ponendo in rilievo il ruolo e le responsabilità delle imprese e promuovendone il miglioramento continuo.</p> <p>Il sistema di gestione ambientale richiesto dallo standard EMAS è basato sulla norma ISO 14001:2004, mentre il dialogo aperto con il pubblico viene perseguito prescrivendo che le organizzazioni pubblichino una Dichiarazione Ambientale in cui sono riportati informazioni e dati salienti dell'azienda in merito ai suoi aspetti e impatti ambientali.</p> <p>EN_ The Eco-Management and Audit Scheme (EMAS) is a voluntary initiative created by the EU, which companies can participate in voluntarily, to assess and improve their environmental performance, providing the public and other relevant parties with information on their environmental management practices. The main priority of EMAS is to contribute to the implementation of sustainable economic development, highlighting the roles and responsibilities of companies and promoting their continuous improvement.</p> <p>The environmental management system stipulated by the EMAS standard is based on the ISO 14001:2004 standard, while open discussion with the public is pursued by stipulating that organisations publish an Environmental Declaration which outlines key details and information about the company, with regard to environmental aspects and impact.</p> |
|  | UNI CEI EN ISO 50001:2018 Sistema di gestione per l'energia Certificato n° 26196 18/10/2018 | <p>L'obiettivo della certificazione ISO 50001 è quello di consentire che un'organizzazione persegua, con un approccio sistematico, il miglioramento continuo delle proprie prestazioni energetiche. Per Italcer S.p.A. SB consiste nel naturale completamento del sistema di gestione ambientale, con importanti ricadute anche sul piano dell'efficienza economica.</p> <p>EN_ The goal of the ISO 50001 certification is to enable an organisation to systematically pursue the continuous improvement of its energy performance. For Italcer S.p.A. SB, this is the natural complement to the environmental management system, with important impacts in terms of economic efficiency as well.</p> |
|  | UNI EN ISO 14001:2015 Sistema di gestione ambientale Certificato n° 12762 24/01/2008 | <p>La certificazione ISO 14001 dimostra che l'azienda ha un sistema di gestione adeguato a tenere sotto controllo gli impatti ambientali delle proprie attività, e ne ricerca sistematicamente il miglioramento.</p> <p>EN_ The ISO 14001 certification demonstrates that the company has a management system suited to keeping the environmental impact of its activities under control, and systematically strives for improvement.</p> |
|  | EPD EPD - COI - 20160202 ICG1 - IT Confindustria Ceramica | <p>EPD è una dichiarazione ambientale di prodotto certificata e verificata da un soggetto indipendente che fornisce un'informazione chiara e confrontabile relativamente alle performance ambientali lungo tutto il suo ciclo di vita, conformemente a quanto stabilito dallo standard ISO 14025. L'industria ceramica italiana si è dotata di questo strumento dal 2015.</p> <p>EN_ EPD is an independently certified and verified environmental product declaration which provides clear and comparable information relating to environmental performance throughout its entire lifecycle, in compliance with the ISO 14025 standard. The Italian ceramics industry has adopted this instrument since 2015.</p> |
|  | GOOD PHYTOSANITARY PRACTICES | <p>I marchi commerciali di Italcer S.p.A. SB sono inseriti nel Registro delle Aziende Qualificate per il rispetto delle Linee Guida del programma "Good Phytosanitary Practices (GPP)", uno standard finalizzato al miglioramento delle pratiche fitosanitarie per procedure di spedizione di container verso gli Stati Uniti. Una certificazione strategica per il miglioramento dei rapporti con gli operatori di uno dei mercati più importanti al mondo.</p> <p>EN_ Italcer S.p.A. SB's trademarks are included in the Register of Qualified Companies for their respect for the Guidelines of the "Good Phytosanitary Practices (GPP)" programme, a standard intended to improve phytosanitary practices for container shipping to the United States. A strategic certification for the improvement of relationships with operators in one of the most important markets in the world.</p> |

Salute e Sicurezza sul Lavoro

| CERTIFICAZIONE - CERTIFICATION CERTIFICATION - BESCHEINIGUNG | NUMERO - NUMBER NOMBRE - ZAHL | DESCRIZIONE / DESCRIPTION / DESCRIPTION / BESCHREIBUNG |
|---|---|--|
|  | UNI ISO 45001:2018 Salute e Sicurezza sul lavoro Certificato n° 27008 04/02/2020 | <p>Lo standard ISO 45001 è la prima norma internazionale a definire gli standard minimi di buona pratica per la protezione dei lavoratori in tutto il mondo. Uno strumento di tutela del patrimonio di salute dei lavoratori, un mezzo per instaurare un rapporto proficuo e trasparente con Organizzazioni Sindacali ed Enti di Controllo, ma soprattutto l'evidenza che si può e si deve fare business nel pieno rispetto dei diritti della Persona.</p> <p>EN_ Occupational health and safety ISO 45001 is the first international standard to define the minimum best practices for worker protection all over the world. A tool to protect worker health, a means to establish a profitable and transparent relationship with trade unions and supervisory bodies, but especially proof that it is possible and indeed necessary to do business with full respect for people's rights.</p> |



Qualità e Sostenibilità

Italcer S.p.a. SB è un'azienda leader nella produzione di piastrelle ceramiche, che si caratterizza non solo per la qualità dei prodotti, ma anche per la sostenibilità sociale ed ambientale della sua gestione. Per noi è impensabile parlare di qualità, successo, miglioramento e sviluppo senza estendere questi concetti ai temi della protezione della Risorsa Umana e della tutela dell'Ambiente, che rappresentano per il Gruppo Italcer la cifra del suo fare impresa e fattore strategico per assicurare successo durevole e capacità di competere a livello mondiale.

Nel 2022 il Gruppo Italcer è stato riconosciuto al vertice della classifica, stilata dal Team Credit Suisse, Kon Group e Forbes, tra le 100 eccellenze italiane premiate al Sustainability Award 2022. Inoltre, nel 2024, si è classificata al primo posto delle "TOP 100 ENVIRONMENTAL >250", ottenendo il punteggio più elevato in campo ambientale tra le imprese candidate con fatturato superiore a 250 milioni di euro (per ulteriori dettagli, vedi a pagina 34).

EN_Quality and Sustainability

Italcer S.p.A. SB is a leader in the production of ceramic tiles, which is known not only for product quality, but also for its socially and environmentally sustainable management. For us, it is unthinkable to speak of quality, success, improvement and development without extending these concepts to the protection of Human Resources and the Environment, which for Italcer Group represent its way of doing business and a strategic factor to ensure lasting success and the capacity to compete at global level.

In 2022 Italcer Group was recognised as one of the top 100 Italian companies to receive the Sustainability Award 2022, in the ratings drawn up by Credit Suisse, Kon Group and Forbes. Furthermore, in 2024, it ranked first in the "TOP 100 ENVIRONMENTAL >250" category, achieving the highest environmental score among companies with a turnover exceeding €250 million (for more details, see page 34).

| CERTIFICAZIONE - CERTIFICATION CERTIFICATION - BESCHEINIGUNG | NUMERO - NUMBER NOMBRE - ZAHL | DESCRIZIONE / DESCRIPTION / DESCRIPTION / BESCHREIBUNG |
|---|--|---|
|  | UNI EN ISO 9001:2015 Qualità Certificato n° 27007 30/05/2019 | <p>Il Sistema di gestione per la qualità ISO 9001 è il "contenitore" che assicura il rispetto di tutti i requisiti cogenti e volontari sottoscritti. Fornisce alla direzione una base dati completa, aggiornata e affidabile che consente di prendere decisioni consapevoli e tempestive, e promuove il miglioramento sinergico e coerente in tutti i processi gestiti dai diversi standard.</p> <p>EN_ The ISO 9001 quality management system is the "container" which ensures respect for all requirements, both binding and voluntary. It provides the management with a complete, updated and reliable database which makes it possible to take knowledgeable and prompt decisions, and promotes synergistic and consistent improvement across all processes managed by the various standards.</p> |

Consigli per la corretta pulizia e manutenzione del prodotto

Pulizia di un pavimento in ceramica

Eseguire una precisa e corretta pulizia del prodotto ceramico è di fondamentale importanza per mantenerne nel tempo l'originaria lucentezza e bellezza. Si raccomanda pertanto di seguire con attenzione le indicazioni seguenti.

A) PULIZIA "DOPO-POSA" IN CANTIERE

Il lavaggio iniziale delle piastrelle nel "dopo-posa" in cantiere è una fase di fondamentale importanza. È infatti in questo momento che è possibile rimuovere agevolmente dalle piastrelle tutti i residui dei materiali usati per la posa e/o della stuccatura delle fughe della piastrella stessa. Si tratta di residui di varia natura che, se lasciati "asciugare e/o seccare" sulle piastrelle, soprattutto in quelle caratterizzate da una superficie strutturata più o meno accentuata potrebbero diventare difficili da rimuovere successivamente. Si raccomanda sempre la massima attenzione alla scelta dell'agente pulente per non alterare irrimediabilmente il grado di lucentezza e brillantezza della piastrella posata.

Pulizia del pavimento stuccato con "Stucchi cementizi a base d'acqua"

Come già accennato, con il lavaggio "dopo-posa" si rimuovono i residui di cemento, stucchi cementizi, salnitri, colle ed eventuali residui superficiali del materiale di varia natura. In questa fase il pavimento deve essere lavato con detergenti a base di acidi tamponati entro almeno 3-4 giorni dopo la posa e mai oltre i 10 giorni.

Pulizia di un pavimento in ceramica

NB: Per i prodotti caratterizzati da superfici strutturate e/o anticivolo si raccomanda, viste le asperità della struttura, di sporcare il meno possibile la superficie della piastrella durante le fasi della posa e di pulire bene subito dopo la stuccatura gli eccessi di materiali utilizzati con una spugna bagnata in acqua pulita. Si raccomanda altresì di eseguire la procedura sotto-descritta il prima possibile e comunque prima dei su citati 3-4 giorni massimi dal "dopo-posa".

Detergenti consigliati:

Keranet Mapei, Deterdek Fila, Deltaplus Kerakoll
Cement Remover Faber Chimica, Deterpav Professional Madras
Gres Cleaner Extreme Special Priscopio Soluzioni, Solvacid Geal

Procedere come segue:

- Preparare il detergente come indicato in etichetta (si consiglia di effettuare prove preliminari su piastrelle non posate per verificare l'inalterabilità della superficie della piastrella).
- Bagnare preventivamente il pavimento con acqua pulita.
- Stendere la soluzione sulle piastrelle lasciando che agisca per qualche minuto.
- Passare la monospazzola utilizzando dischi appropriati (verdi per le superfici strutturate e rosso per le non strutturate) o una paglietta (verde per le superfici strutturate e rossa/marrone per le non strutturate) strofinando energicamente la superficie delle piastrelle.
- Risciacquare abbondantemente con acqua pulita aspirando il liquido.

Pulizia del pavimento stuccato con "Stucchi epossidici"

Nel caso di utilizzo di stucchi epossidici, considerato che essi induriscono rapidamente in pochi minuti, il lavaggio "dopo-posa" deve essere eseguito con detergenti alcalini il più rapidamente possibile attenendosi scrupolosamente alle indicazioni e procedure d'utilizzo indicati in etichetta.

Detergenti alcalini consigliati:

Kerapoxy Cleaner Mapei, PS/87 Fila, Epoxy Remover Laticret, Keragel Eco Kerakoll, Wax Remover Faber Chimica, Epoxy,Det Technokolla, Epoxy Cleaner Extreme Periscopio Soluzioni, Eposolu Geal

Procedere come segue:

- Preparare il detergente come indicato in etichetta (si consiglia di effettuare prove preliminari su piastrelle non posate per verificare l'inalterabilità della superficie della piastrella).
- Bagnare preventivamente il pavimento con acqua pulita.
- Stendere la soluzione sulle piastrelle lasciando che agisca per qualche minuto
- Passare la monospazzola utilizzando dischi appropriati (verdi per le superfici strutturate e rosso per le non strutturate) o una paglietta (verde per le superfici strutturate e rossa/marrone per le non strutturate) strofinando energicamente la superficie delle piastrelle.
- Risciacquare abbondantemente con acqua pulita aspirando il liquido

B) PULIZIA QUOTIDIANA

La pulizia ordinaria può essere fatta con l'ausilio di normali detergenti neutri adatti alla pulizia delle superfici ceramiche (es. Aquasol food), eventualmente diluendoli in acqua calda per aumentarne l'efficacia, attenendosi alle istruzioni in etichetta del produttore.

N.B.: Si raccomanda di non utilizzare Acido Muriatico e Acido Fosforico sul gres porcellanato in generale, in quanto questi acidi possono danneggiare irreversibilmente la superficie e compromettere la lucentezza del materiale.

| Tipologie di Detergenti dove è consentita la vendita Types of Detergents where sales are permitted | SOLVENTI SOLVENTS | | ACIDI ACIDS | | ALCALI ALKALI | |
|--|-----------------------------|------|-----------------------|------|-------------------------|------|
| SUPERFICIE. SURFACE | NAT | LAPP | NAT | LAPP | NAT | LAPP |
| TIPI DI MACCHIE. TYPES OF STAIN | | | | | | |
| BIRRA. BEER | | | | | ● | ● |
| CAFFÈ. COFFEE | | ● | | | | |
| CALCARE. LIME | | | ● | ● | | |
| CATrame. TAR | ● | ● | | | | |
| CEMENTO. CEMENT | | | ● | ● | | |
| CERA DI CANDELA. CANDLE WAX | ● | ● | | | | |
| COCA COLA | | ● | | | | ● |
| COLLA. GLUE | | ● | | | | ● |
| GELATO. ICE CREAM | | | | | | ● |
| GOMMA DA MASTICARE. CHEWING GUM | ● | ● | | | ● | ● |
| GOMMA DI PNEUM. SCARPE. TYRE RUBBER, SHOES | ● | ● | | | | ● |
| GRASSO, OLIO GREASE, OIL. | | | | | ● | ● |
| INCHIOSTRO. INK | ● | ● | | | | |
| NICOTINA. NICOTINE | | | | | ● | ● |
| PENNARELLO. FELT-TIP PEN | ● | ● | | | | |
| RESINE. RESINS | ● | ● | | | | |
| RUGGINE. RUST | | | ● | ● | | |
| SANGUE. BLOOD | | | | | ● | ● |
| SMALTO PER UNGHIE. NAIL POLISH | ● | ● | | | | |
| SIGARETTA. CIGARETTE | | | ● | ● | | |
| VERNICE MURALE. WALL PAINT | ● | ● | ● | ● | | |
| VINO. WINE | | ● | | | | |

EN_Important product cleaning and maintenance.

Proper, careful cleaning of your ceramic product is vitally important to ensure it keeps its original gloss and beauty over time. We therefore recommend that you follow the instructions set out below carefully.

A) POST-LAYING CLEANING IN THE WORKSITE

The initial post-laying cleaning of the tiles in the worksite is a key procedure.

In actual fact, this is the easiest time to remove any residues of the laying materials used and or grouting from the tiles. These residues (of various kinds) may be hard to remove later if left to dry on the tiles, particularly those featuring a textured surface however accentuated this texture may or may not be. We always recommend you take particular care when choosing the cleaning agent, as the wrong product could irreversibly alter the level of glossy and shine of the laid tiles.

Cleaning flooring grouted with water-based cement grouts

As already mentioned, the post-laying wash removes all traces of cement, cement-based grouts, saltpetre, glues and any surface residues of various kinds of materials. At this stage, the floor should be washed with detergents containing buffered acids at least 3-4 days after laying and never later than 10 days afterwards.

Pulizia di un pavimento in ceramica

NB: For tiling with textured and/or non-slip surfaces we recommend that - given the harshness of the texture - you try to soil the tile surface as little as possible during laying and that you clean off excess materials well straight after grouting, using a wet sponge and clean water. We also recommend you carry out the procedure described below as soon as possible and within no more than the aforesaid 3 to 4 days after laying.

Recommended detergents:

Keranet Mapei, Deterdek Fila, Deltaplus Kerakoll
Cement Remover Faber Chimica, Deterpav Professional Madras
Gres Cleaner Extreme Special Priscopio Soluzioni, Solvacid Geal

Proceed as follows:

- Prepare the detergent as stated on the label (we recommend you carry out a preliminary test on unlaid tiles to check the resistance of the tile surface).
- Wet the floor with clean water beforehand.
- Spread the solution on the tiles, leaving it to work for a few minutes.
- Go over the floor with the single-disc floor cleaner, using suitable disks (i.e. green for textured surfaces and red for non-textured surfaces) or an abrasive pad (green for textured surfaces and red/ brown for non-textured surfaces), scrubbing surface of the tiles well.
- Rinse thoroughly with clean water, then vacuum up the liquid.

Cleaning flooring grouted with epoxy grouts

If you are using an epoxy grout, given that these harden extremely quickly (in just a few minutes), the post-laying wash must be carried out using alkaline cleaning agents and as quickly as possible, following the instructions for use and procedures on the label exactly as stated.

Recommended alkaline detergents:

Kerapoxy Cleaner Mapei, PS/87 Fila, Epoxy Remover Laticret, Keragel Eco Kerakoll, Wax Remover Faber Chimica, Epoxy,Det Technokolla, Epoxy Cleaner Extreme Periscopio Soluzioni, Eposolu Geal

Proceed as follows:

- Prepare the detergent as stated on the label (we recommend you carry out a preliminary test on unlaid tiles to check the resistance of the tile surface).
- Wet the floor with clean water beforehand.
- Spread the solution on the tiles, leaving it to work for a few minutes.
- Go over the floor with the single-disc floor cleaner, using suitable disks (i.e. green for textured surfaces and red for non-textured surfaces) or an abrasive pad (green for textured surfaces and red/ brown for non-textured surfaces), scrubbing surface of the tiles well.
- Rinse thoroughly with clean water, then vacuum up the liquid.

B) DAILY CLEANING

Routine cleaning can be carried out using normal neutral detergents that are suitable for cleaning ceramic surfaces (e.g. Aquasol food), diluting them in hot water (if possible) to increase their effectiveness and following the manufacturer's instructions found on the label.

Pulizia di un pavimento in ceramica

NB: It is recommended not to use Muriatic Acid and Phosphoric Acid on porcelain stoneware in general, as these acids can irreversibly damage the surface of the tiles, compromising their shine and durability.

FR_Conseils pour le nettoyage et l'entretien corrects du produit.

Un nettoyage minutieux et correct du produit en céramique est fondamental pour en préserver le brillant et la beauté d'origine. Il est donc recommandé de suivre avec attention les indications suivantes.

A) NETTOYAGE "APRÈS LA POSE" SUR LE CHANTIER

Le lavage initial des carreaux au cours de la phase "après la pose" sur le chantier est une étape extrêmement importante.

En effet, c'est à ce moment-là qu'il est possible d'éliminer facilement des carreaux tous les résidus du matériel utilisé pour la pose et/ou du jointage des joints.

Il s'agit de résidus de différente nature qui pourraient s'avérer difficiles à éliminer par la suite, si on les laisse "sécher et/ou durcir" sur les carreaux, surtout s'ils sont caractérisés par une surface structurée plus ou moins accentuée. On recommande toujours de choisir le produit de nettoyage avec la plus grande attention pour ne pas altérer irrémédiablement le degré de luisance et de brillance du carreau posé.

Nettoyage des carrelages jointes avec des "Mastics à base de ciment et d'eau".

Comme on l'a dit, le lavage "après la pose" permet d'éliminer les résidus de béton, les mastics à base de ciments, les nitrates de potassium, les colles et les éventuels résidus superficiels de différente nature. Au cours de cette phase, le carrelage doit être lavé avec des détergents à base d'acides tamponnés au moins 3-4 jours après la pose et au maximum dans les 10 jours.

Pulizia di un pavimento in ceramica

N.B.: Pour les produits caractérisés par des surfaces structurées et/ou antidérapantes, il est recommandé, vu les aspérités de la structure, de salir le moins possible la surface du carreau au cours de la pose et de bien éliminer les excès de produit utilisé immédiatement après le jointage avec une éponge imbibée d'eau propre. Il est également recommandé d'exécuter la procédure décrite ci-dessous dès que possible et au plus tard avant la période maximale de 3-4 jours indiquée plus haut à compter de l"après-pose".

Détergents préconisés:

Keranet Mapei, Deterdek Fila, Deltaplus Kerakoll
Cement Remover Faber Chimica, Deterpav Professional Madras
Gres Cleaner Extreme Special Priscopio Soluzioni, Solvacid Geal

Procéder comme suit:

- Préparer le détergent d'après les indications figurant sur l'étiquette (il est recommandé d'effectuer des essais préliminaires sur des carreaux non posés pour vérifier l'inaltérabilité de la surface des carreaux).
- Mouiller préalablement le carrelage avec de l'eau propre.
- Etaler la solution sur les carreaux en laissant agir quelques minutes.
- Passer la monobrosse en utilisant les disques appropriés (verts pour les surfaces structurées et rouges pour les surfaces non structurées) ou une paille de fer (verte pour les surfaces structurées et rouge/marron pour les surfaces non structurées) en frottant énergiquement la surface des carreaux.
- Rincer abondamment à l'eau propre en aspirant le liquide. Nettoyage des carrelages jointes avec des "Mastics époxy" Si l'on utilise des mastics époxy, vu qu'ils durcissent rapidement en quelques minutes, le lavage "après la pose" doit être effectué avec des détergents alcalins dans les plus brefs délais en suivant scrupuleusement les indications et les procédures d'utilisation figurant sur l'étiquette.

Détergents alcalins préconisés:

Kerapoxy Cleaner Mapei, PS/87 Fila, Epoxy Remover Laticret, Keragel Eco Kerakoll, Wax Remover Faber Chimica, Epoxy,Det Technokolla, Epoxy Cleaner Extreme Periscopio Soluzioni, Eposolu Geal

Procéder comme suit:

- Préparer le détergent d'après les indications figurant sur l'étiquette (il est recommandé d'effectuer des essais préliminaires sur des carreaux non posés pour vérifier l'inaltérabilité de la surface des carreaux)
- Mouiller préalablement le carrelage avec de l'eau propre
- Etaler la solution sur les carreaux en laissant agir quelques minutes
- Passer la monobrosse en utilisant les disques appropriés (verts pour les surfaces structurées et rouges pour les surfaces non structurées) ou une paille de fer (verte pour les surfaces structurées et rouge/marron pour les surfaces non structurées) en frottant énergiquement la surface des carreaux.
- Rincer abondamment à l'eau propre en aspirant le liquide

B) NETTOYAGE QUOTIDIEN

Le nettoyage quotidien peut être réalisé à l'aide de détergents neutres normaux indiqués pour le nettoyage des surfaces en céramique (p. ex. Aquasol food), éventuellement en les diluant dans de l'eau chaude pour en augmenter l'efficacité, en suivant les instructions du producteur sur l'étiquette.

Pulizia di un pavimento in ceramica

NB: Il est recommandé de ne pas utiliser d'acide chlorhydrique et d'acide phosphorique sur le grès cérame en général, car ces acides peuvent endommager irréversiblement la surface des carreaux, compromettant leur brillance et leur durabilité.

DE_Hinweise und Empfehlungen für die richtige Reinigung und Pflege des Produktes.

Eine gründliche und richtige Reinigung des Keramikproduktes ist von grundlegender Wichtigkeit, um den Glanz und die Schönheit in ursprünglicher Form dauerhaft aufrechtzuerhalten Es wird deshalb geraten, die folgenden Hinweise mit Aufmerksamkeit zu beachten.

A) REINIGUNG "NACH DER VERLEGUNG" AUF DER BAUSTELLE
Das anfängliche Reinigen der Fliesen "nach der Verlegung" auf der Baustelle ist eine Phase von grundlegender Wichtigkeit.

So ist es zu diesem Zeitpunkt möglich, mühelos alle Rückstände der zur Verlegung und/oder Verspachtelung der Fliesenfugen verwendeten Produkte zu entfernen. Es handelt sich um Rückstände verschiedener Art, die vor allem, wenn sie auf den mit einer mehr oder wenig strukturierten Oberfläche gekennzeichneten Fliesen "trocknen und/oder austrocknen", sich nur schwer später entfernen lassen. Es wird immer zur höchsten Sorgfalt hinsichtlich der Wahl des Reinigungsmittels geraten, um den Grad des Schimmers und Glanzes der verlegten Fliese nicht unrettbar zu beeinträchtigen.

Reinigung des mit "Zementspachtel auf Wasserbasis" verfugten Bodens.

Wie bereits erwähnt, werden mit der Reinigung "nach der Verlegung" die Rückstände von Zement, Zementspachtel, Salpeter, Kleber und andere eventuelle Rückstände verschiedener Art auf der Oberfläche des Materials entfernt. In dieser Phase muss der Fußboden mit Reinigungsmitteln auf Basis von gepuffterter Säure innerhalb von mindestens 3-4 Tagen und niemals später als 10 Tagen nach der Verlegung gereinigt werden.

Pulizia di un pavimento in ceramica

ANM.: Für die durch strukturierte und/oder rutschfeste Oberflächen gekennzeichneten Produkte wird im Hinblick auf die Rauhgigkeit der Struktur geraten, die Oberfläche der Fliese bei der Verlegung so wenig wie möglich zu verschmutzen und die Rückstände verwendeter Materialien sofort nach der Verfugung mit einem in sauberem Wasser nass gemachten Schwamm zu beseitigen. Außerdem wird geraten, den unten beschriebenen Vorgang sobald wie möglich und in jedem Fall vor den oben genannten 3-4 Tagen maximal "nach der Verlegung" auszuführen.

Empfohlene Reinigungsmittel:

Keranet Mapei, Deterdek Fila, Deltaplus Kerakoll
Cement Remover Faber Chimica, Deterpav Professional Madras
Gres Cleaner Extreme Special Priscopio Soluzioni, Solvacid Geal

Gehen Sie wie folgt vor:

- Bereiten Sie das Reinigungsmittel gemäß den Angaben auf dem Etikett zu (es wird geraten, vorab Tests auf einer nicht verlegten Fliese durchzuführen, um die Unveränderlichkeit der Oberfläche der Fliese zu prüfen).
- Benässen Sie zuvor den Fußboden mit sauberem Wasser.
- Tragen Sie die Lösung auf die Fliesen auf und lassen Sie sie einige Minuten einwirken.
- Fahren Sie mit der Reinigungsmaschine unter Verwendung geeigneter Scheiben (grün für die strukturierten Oberflächen und rot für die nicht strukturierten) oder einem Schwamm (grün für die strukturierten Oberflächen und rot/braun für die nicht strukturierten) darüber, und reiben Sie energisch über die Oberfläche der Fliesen.
- Wischen Sie mit reichlich sauberem Wasser nach und saugen Sie die Flüssigkeit auf.

Reinigung des mit "Epoxid-Spachtel" verfugten Fußbodens

Bei Verwendung von Epoxid-Spachteln muss die Reinigung „nach der Verlegung“ in Anbetracht ihrer schnellen Aushärtung in wenigen Minuten so schnell wie möglich mit alkalischen Reinigungsmitteln ausgeführt werden, wobei die Hinweise und Verwendungsweise auf dem Etikett genauestens zu beachten sind.

Empfohlene alkalische Reinigungsmittel:

Kerapoxy Cleaner Mapei, PS/87 Fila, Epoxy Remover Laticret, Keragel Eco Kerakoll, Wax Remover Faber Chimica, Epoxy,Det Technokolla, Epoxy Cleaner Extreme Periscopio Soluzioni, Eposolu Geal

Gehen Sie wie folgt vor:

- Bereiten Sie das Reinigungsmittel gemäß den Angaben auf dem Etikett zu (es wird geraten, vorab Tests auf einer nicht verlegten Fliese durchzuführen, um die Unveränderlichkeit der Oberfläche der Fliese zu prüfen).
- Benässen Sie zuvor den Fußboden mit sauberem Wasser.
- Tragen Sie die Lösung auf die Fliesen auf und lassen Sie sie einige Minuten einwirken.
- Fahren Sie mit der Reinigungsmaschine unter Verwendung geeigneter Scheiben (grün für die strukturierten Oberflächen und rot für die nicht strukturierten) oder einem Schwamm (grün für die strukturierten Oberflächen und rot/braun für die nicht strukturierten) darüber, und reiben Sie energisch über die Oberfläche der Fliesen.
- Wischen Sie mit reichlich sauberem Wasser nach und saugen Sie die Flüssigkeit auf.

B) TÄGLICHE REINIGUNG

Die gewöhnliche Reinigung kann mit Hilfe normaler neutraler Reinigungsmittel erfolgen, die für die Reinigung von Oberflächen aus Keramik geeignet sind (z.B. Aquasol food), wobei diese eventuell in warmem Wasser verdünnt werden, um ihre Wirksamkeit zu erhöhen. Beachten Sie die Angaben des Herstellers auf dem Etikett.

Pulizia di un pavimento in ceramica

ANM.: Es wird empfohlen, Salzsäure und Phosphorsäure im Allgemeinen nicht auf Feinsteinzeug zu verwenden, da diese Säuren die Oberfläche der Fliesen irreversibel beschädigen und ihre Glanz und Haltbarkeit beeinträchtigen können.

Condizioni generali di vendita

IT_ Italcer S.p.A. SB ("Italcer") si riserva il diritto di modificare in qualunque momento le informazioni e le caratteristiche tecniche contenute nel catalogo ("**Catalogo**") e nel sito web, www.lafabbrica.it (il "**Sito**") (inclusi tutti i documenti e cataloghi scaricabili via internet), che non sono da ritenersi legalmente vincolanti. Pesi, colori e misure dei Prodotti ceramici venduti (i "**Prodotti**") possono subire variazioni tipiche del particolare processo di produzione del materiale ceramico. I colori e le caratteristiche estetiche dei Prodotti sono quanto più possibile vicini a quelli reali, nei limiti consentiti dai processi di riproduzione virtuale. Italcer considera le informazioni e le specifiche tecniche di cui al presente Catalogo corrette e precise; tuttavia, non esclude la presenza di errori materiali ed invita i compratori ("**Compratori**") a verificare le informazioni e le specifiche tecniche con gli agenti / commerciali di riferimento.

©2024 Italcer S.p.A. SB Tutti i diritti sono riservati. Ogni riproduzione totale e/o parziale dei contenuti del presente Catalogo, sia di testo che di immagine, è vietata e sarà perseguita nei termini di legge.

1. PRODOTTI E GARANZIA

- Le elevate temperature di cottura dei Prodotti possono provocare differenze di tono e di calibro. Sono perciò ammesse ed accettate dal Compratore delle differenze nelle dimensioni indicate, che però non superino i limiti di tolleranza prevista dalle norme UNI-EN-ISO 14411, fatta eccezione per talune categorie di Prodotti che, richiamando l'artigianalità dei processi produttivi tradizionali e presentando irregolarità intrinseche e differenze dimensionali volutamente ricercate, esulano dall'applicazione della suddetta normativa (a titolo esemplificativo e non esaustivo, i Prodotti delle collezioni "Brick").
- Fatta eccezione per quanto precede, Italcer garantisce i Prodotti come conformi alle norme UNI-EN-ISO 14411 attualmente in vigore. La garanzia è limitata esclusivamente ai materiali di prima scelta. I Prodotti di seconda e di terza scelta, le partite occasionali e i Prodotti usciti di produzione si intendono venduti "venduti nello stato in cui si trovano, senza possibilità di reclamo successivo".
- Le colorazioni dei Prodotti presentati in campionature sono da considerarsi puramente indicative. Eventuali variazioni di colore, di tonalità o di superficie sono giustificate dalla natura stessa del materiale, dalle caratteristiche dei cicli di produzione e dalle materie prime impiegate. Si consiglia pertanto di miscelare i Prodotti, prelevandoli da diverse scatole, e di posarli come da istruzioni pubblicate sul Sito. Decorati e pezzi speciali sono forniti in tonalità differenziate dal fondo.
- Italcer non è responsabile per attività di levigatura e lucidatura effettuate dai clienti a seguito della consegna dei Prodotti.

2. ORDINI

- Ogni ordine trasmesso a Italcer dal Compratore, dagli agenti rappresentanti o incaricati è da intendersi accettato sempre salvo approvazione della direzione di Italcer.
- Tutte le ordinazioni, anche verbali, salvo accordi contrari scritti, si intendono sempre accettate da Italcer alle presenti condizioni generali, senza bisogno di richiamarle. In assenza di precise eccezioni scritte, si intende che il Compratore accetta integralmente le condizioni particolari e generali di vendita.
- Qualora si verifichino cause di forza maggiore, Italcer potrà recedere in parte o in toto dal contratto di vendita.

3. PREZZI

- I prezzi si intendono per merce resa EXW (Incoterms 2020) presso il magazzino di volta in volta indicato da Italcer, IVA esclusa.
- I prezzi degli imballaggi sono indicati nel relativo listino e variano a seconda delle diverse tipologie di imballaggio.

4. CONSEGNA

- I termini di consegna concordati con Italcer sono da intendersi puramente indicativi e non vincolanti per Italcer. Eventuali ritardi nella consegna non danno mai il diritto al Compratore di annullare il contratto, né di pretendere il risarcimento di eventuali danni diretti o indiretti, ogni eccezione esclusa.
- Italcer si riserva il diritto di effettuare ragionevoli consegne parziali.
- La merce si intende acquistata dal Compratore EXW (Incoterms 2020) presso il magazzino di volta in volta indicato da Italcer. La merce viaggia sempre e comunque a rischio e pericolo del Compratore, anche qualora il prezzo fosse franco destino.
- Il Compratore è obbligato a ritirare i Prodotti entro 2 (due) giorni lavorativi dalla data di "merce pronta" indicata nella comunicazione inviata da Italcer. Trascorsi 60 (sessanta) giorni dalla data indicata come "merce pronta" senza che il Compratore abbia provveduto al ritiro, il contratto di compravendita si intenderà automaticamente risolto ai sensi dell'art. 1456 c.c. Italcer, inoltre, si riserva il diritto di annullare l'ordine e di addebitare al Compratore:

- per i Prodotti standard: un importo a titolo di spese di movimentazione e gestione, compreso tra un minimo del 20% e un massimo del 50% del valore dei Prodotti;
- per i Prodotti Custom Made: il 100% del valore di vendita dei Prodotti, oltre ai costi di movimentazione e smaltimento.

- Al ricevimento del materiale, il Compratore deve verificare accuratamente: (i) che il numero di colli consegnati sia coerente con quelli ordinati ed indicati sui documenti di trasporto; (ii) lo stato fisico dei colli, controllando che questi non siano stati manomessi e/o danneggiati; (iii) difetti nella merce immediatamente visibili alla consegna. In caso di anomalie / difetti dovrà apporre la dicitura "accettato con riserva", inserendo il motivo direttamente sul documento di consegna. Entro 24 (ventiquattro) ore dalla consegna, il Compratore dovrà altresì comunicare a Italcer per iscritto al seguente indirizzo email claim@gruppoitalcer.it le anomalie e/o i difetti riscontrati. Italcer non accetterà alcuna contestazione relativamente a quanto sopra se non annotata sul documento di consegna e comunicata nei suddetti termini.

5. PAGAMENTO e RISERVA DI PROPRIETA':

- I pagamenti devono essere eseguiti a favore di Italcer, secondo le modalità concordate e riportate nella fattura. I termini di pagamento sono tassativi e il loro mancato rispetto determinerà l'applicazione, sulla somma dovuta, degli interessi moratori al tasso previsto e stabilito dal D.lgs. n. 231 del 2002, senza necessità di formale costituzione in mora.
- In caso di ritardo nel pagamento totale o anche parziale di una fattura, Italcer, salvi tutti gli altri suoi diritti, avrà facoltà di sospendere le ulteriori consegne, anche se queste fossero dovute in dipendenza di altri contratti ed anche di pretendere l'immediato e intero pagamento di tutti i Prodotti ordinati, o di averlo in altro modo garantito.
- Si concorda espressamente che la merce consegnata rimane di proprietà di Italcerfino al completo pagamento del prezzo di acquisto da parte del Compratore. Il mancato pagamento di una delle rate può comportare automaticamente, senza formalità o preavviso, il recupero della merce da parte di Italcer ed il Compratore sarà tenuto a restituirla senza indugio. In caso di sequestro o di qualsiasi altro intervento da parte di terzi sulla merce venduta, il Compratore dovrà notificare a tali terzi l'esistenza della presente clausola di riserva di proprietà e informare tempestivamente Italcer, al fine di consentire la tutela dei propri diritti.

6. RECLAMI

- Non si accettano reclami per vizi palesi o accertabili con diligenza qualificata, per materiali già posati in opera.
- I vizi occulti devono essere comunicati a Italcer per iscritto (claim@gruppoitalcer.it) entro 8 giorni dalla loro scoperta e in ogni caso non oltre entro 24 (ventiquattro) mesi dalla consegna.
- Fatto salvo quanto previsto dal precedente punto 4 e., reclami per vizi e difetti dei Prodotti devono contenere:

- dati del Prodotto e numero di lotto;
- dettagli e spiegazione del presunto difetto;
- adeguata documentazione fotografica.

- Italcer garantisce, in caso di Prodotto difettoso/viziato, esclusivamente la sostituzione dei Prodotti non conformi all'ordine, con l'espressa esclusione del risarcimento di tutti i danni, patrimoniali e non, subiti direttamente o indirettamente.
- Qualsiasi reclamo o contestazione non implica la sospensione ed il rifiuto al pagamento delle fatture.Il pagamento dovrà effettuarsi regolarmente ed integralmente nei termini convenuti.
- Non si accettano resi di merce se non autorizzati per iscritto da Italcer.

7. FORO COMPETENTE E LEGGE APPLICABILE

Per qualsiasi controversia il Foro competente è quello di Reggio Emilia (Italia) e la legge italiana quella applicabile. Tuttavia, Italcer si riserva il diritto di agire presso il foro competente della sede del Compratore per azioni volte al recupero del credito. In tal caso troverà applicazione la legge locale.

Le presenti condizioni generali sono redatte in molteplici lingue. In caso di discrepanze tra i diversi testi prevale la lingua italiana.

EN_ General sales conditions

Italcer S.p.A. SB ("**Italcer**") reserves the right to modify the information and technical specifications contained in the catalogue ("**Catalogue**") and on the website, www.lafabbrica.it (the "**Website**") (including all downloadable documents and catalogues) at any time, as these are not legally binding. The weights, colours and sizes of the ceramic products sold (the "**Products**") may vary due to the particular manufacturing processes involved. While Italcer strives to ensure that the colours and aesthetic characteristics of its Products are as accurate as possible, there may be some variation due to the limitations of virtual reproduction. Italcer believes the information and the technical specifications in this Catalogue to be accurate; however, it does not exclude the possibility of material errors. Buyers ("**Buyers**") are advised to check and confirm all details with their relevant agents or sales representatives.

©2024 Italcer S.p.A. SB All rights reserved. Any unauthorised reproduction, in whole or in part, of the contents of this Catalogue, whether text or images, is prohibited and will be prosecuted in accordance with applicable laws.

1. PRODUCTS AND WARRANTY

- Due to the high firing temperatures, variations in tone and gauge may occur to the Products. Differences in the indicated dimensions are therefore allowed and accepted by the Buyer, provided they do not exceed the tolerance limits specified by the UNI-EN-ISO 14411 standards, with the exception of certain categories of Products which, because they reflect traditional craftsmanship processes, intentionally displaying irregularities and variations in size that are deliberately sought, are not subject to the application of the aforesaid standards (by way of example but not limited to the Products of the "Brick" collections).
- With the exception of the foregoing, Italcer warrants that its Products comply with currently valid UNI-EN-ISO 14411 standards. The warranty is limited to first-choice materials only. Second- and third-choice Products, occasional batches and Products that are already out of production shall be deemed to be sold "as is", without any possibility of subsequent claims.
- The colours of the Products presented in samples are to be deemed purely indicative. Variations in colour, shade or surface are inherent in the material itself, the characteristics of the production cycles and the raw materials used. Customers are advised to mix Products from different boxes and follow the installation instructions provided on the Website.
- Decorations and special pieces may differ in shade from the background.
- Italcer disclaims liability for any sanding or polishing work performed by customers after the Products have been delivered.

2. ORDERS

- Any orders submitted to Italcer by the Buyer, its representative or appointed agents shall always be deemed accepted subject to approval by Italcer's management.
- All orders, including verbal orders, unless otherwise agreed in writing, are always to be considered accepted by Italcer under these general terms and conditions, without the need to refer to such terms and conditions. In the absence of precise written exceptions, the Buyer shall be deemed to have fully agreed to all general terms and conditions of sale.
- In the event of force majeure circumstances, Italcer shall be entitled to partially or fully withdraw from the contract of sale.

3. PRICES

- Prices are for Products delivered EXW (Incoterms 2020) from the warehouse indicated by Italcer from time to time, excluding VAT.
- Packaging costs are indicated on the relevant price list and may vary based on the type of packaging.

4. DELIVERY

- The delivery terms agreed with Italcer are to be understood as purely indicative and not binding for Italcer. Any delays in delivery shall never entitle the Buyer to cancel the contract, or claim compensation for any direct or indirect damages, with no exceptions.
- Italcer reserves the right to make reasonable partial deliveries.
- The Products are deemed to be purchased by the Buyer EXW (Incoterms 2020) at the warehouse indicated by Italcer from time to time. The Products always travel at the Buyer's risk, even if the price is carriage free.
- The Buyer shall be obliged to collect the Products within 2 (two) working days from the receipt of the notice of the Products being ready for pickup – to be sent by Italcer. If 60 (sixty) days have passed from the date indicated as " Products ready for pick up" without the Buyer having collected them, the sales contract will be considered automatically terminated pursuant to art. 1456 of Italian Civil Code and Italcer reserves the right to cancel the order and to charge the Buyer:

- for standard Products: between a minimum of 20% and a maximum of 50% of the value of the Products, as compensation for handling and management costs;
- for Custom Made Products: 100% of the sales value of the Products, in addition to handling and disposal costs.

- Upon receipt of the Products, the Buyer must carefully check: (i) that the number of packages delivered matches those ordered and indicated on the transport documents; (ii) the physical condition of the packages, making sure that they have not been tampered with and/or damaged; (iii) for any defects in the Products which are immediately visible upon delivery. In the event of anomalies/defects, the Products shall be marked "accepted with reservation", entering the reason directly on the delivery document. Within 24 (twenty-four) hours from delivery, the Buyer shall also notify Italcer in writing of the anomalies and/or defects found to the following email address claim@gruppoitalcer.it. Italcer will not accept any claim in respect of the above unless noted on the delivery document and communicated within the above terms.

5. PAYMENT and RETENTION OF TITLE

- Payments shall be made in favour of Italcer, according to the terms agreed upon and set out in the invoice. Payment terms are mandatory and failure to comply with them shall result in the application, on the sum due, of default interest at the rate provided for and established by Legislative Decree no. 231 of 2002, without the need for formal notice of default.
- In the event of delay in the total or even partial payment of an invoice, Italcer, without prejudice to all its other rights, shall be entitled to suspend further deliveries, even if these were due under other contracts, and also to demand immediate and full payment of all the Products ordered, or to have such payment otherwise guaranteed.
- It is expressly agreed that the delivered Products shall remain the property of Italcer until full payment of the purchase price by the Buyer. Failure to pay any of the instalments may automatically, without formalities or prior notice, result in the recovery of the Products by Italcer and the Buyer shall be obliged to return such Products without delay. In the event of seizure or any other intervention by third parties on the sold Products, the Buyer shall notify such third parties of the existence of this retention of title clause and promptly inform Italcer in order to enable it to protect its rights.

6. CLAIMS

- No claims are accepted for obvious or detectable defects, once the materials have been installed.
- Hidden defects must be reported to Italcer in writing (claim@gruppoitalcer.it) within 8 days of their discovery and in any case no later than 24 (twenty-four) months from delivery.
- Without prejudice to the provisions of par. 4 e. above, claims for flaws and defects in the Products must contain:
 - product data and batch number;
 - detailed description of the alleged defect;
 - adequate photographic evidence.

- In the event of a flawed/defective Product, Italcer will replace only those Products that do not conform to the order, with the express exclusion of compensation for all damages, pecuniary or otherwise, suffered directly or indirectly.
- Claims shall not affect the Buyer's obligation to pay invoices, which must be paid in full and on time.
- Returned Products shall not be accepted unless authorised in writing by Italcer.

7. JURISDICTION AND APPLICABLE LEGISLATION

For any dispute, the competent Court shall be that of Reggio Emilia (Italy) and Italian law shall be applicable. However, Italcer reserves the right to take legal action at the competent court of the Buyer's registered office for credit recovery, in which case local laws shall apply.

These general terms and conditions of sale are drawn up in several languages. In case of discrepancies between the different texts, the Italian language shall prevail.

FR_Conditions générales de vente

Italcer S.p.A. SB (« **Italcer** ») se réserve le droit de modifier à tout moment les informations et les caractéristiques techniques contenues dans le catalogue (« **Catalogue** ») et sur le site internet, www.lafabbrica.it (le « **Site** ») (y compris tous les documents et catalogues téléchargeables sur Internet), qui ne sont pas juridiquement contraignantes. Les poids, les couleurs et les dimensions des Produits céramiques vendus (les « **Produits** ») peuvent varier en raison du processus particulier de fabrication du matériau céramique. Les couleurs et les caractéristiques esthétiques des Produits sont aussi proches que possible des produits réels, dans les limites permises par les procédés de reproduction virtuelle. Italcer considère que les informations et les caractéristiques techniques contenues dans le présent Catalogue sont correctes et précises ; toutefois, celle-ci n'exclut pas la présence d'erreurs matérielles et invite les acheteurs (« **Acheteurs** ») à vérifier les informations et les caractéristiques techniques auprès des agents/représentants commerciaux concernés.

©2024 Italcer S.p.A. SB Tous droits réservés. Toute reproduction totale et/ou partielle du contenu du présent Catalogue, qu'il s'agisse de texte ou d'image, est interdite et sera punie conformément à la loi.

1. PRODUITS ET GARANTIE

- Les températures élevées de cuisson des Produits peuvent entraîner des différences de nuance et de calibre. Des différences dans les dimensions indiquées sont donc admises et acceptées par l'Acheteur, à condition qu'elles ne dépassent pas les limites de tolérance prévues par les normes UNI-EN-ISO 14411, à l'exception de certaines catégories de Produits qui, étant donné le caractère artisanal des processus de production traditionnels, les irrégularités intrinsèques et les différences de dimensions délibérément recherchées, ne sont pas soumises à l'application des normes susmentionnées (à titre d'exemple mais de manière non exhaustive, les Produits des collections « Brick »).
- À l'exception de ce qui précède, Italcer garantit que les Produits sont conformes aux normes UNI-EN-ISO 14411 en vigueur. La garantie se limite exclusivement aux matériaux de premier choix. Les Produits de deuxième et troisième choix, les lots occasionnels et les Produits sortis de la production sont considérés comme « endus dans l'état dans lequel ils se trouvent, sans possibilité de réclamation ultérieure».
- Les couleurs des Produits présentés dans les échantillons doivent être considérées comme purement indicatives. Les éventuelles variations de couleur, de nuance ou de surface sont justifiées par la nature même du matériau, les caractéristiques des cycles de production et les matières premières utilisées. Il est donc recommandé de mélanger les Produits, de les prendre dans des emballages différentes et de les poser selon les instructions publiées sur le Site.
- Les décorations et les pièces spéciales sont fournies dans des nuances différentes de celles du fond.
- Italcer n'est pas responsable des activités de ponçage et de polissage effectuées par les clients après la livraison des Produits.

2. COMMANDES

- Chaque commande transmise à Italcer par l'Acheteur, ses représentants, agents ou responsables est toujours considérée comme acceptée sous réserve de l'approbation de la direction d'Italcer.
- Toutes les commandes, y compris les commandes verbales, sauf accord écrit contraire, sont toujours considérées comme acceptées par Italcer en vertu des présentes conditions générales, sans qu'il soit nécessaire d'y faire référence. En l'absence d'exceptions écrites précises, il est entendu que l'Acheteur accepte pleinement les conditions particulières et générales de vente.
- En cas de force majeure, Italcer pourra résilier partiellement ou totalement le contrat de vente.

3. PRIX

- Les prix sont indiqués pour marchandise rendue EXW (Incoterms 2020) à l'entrepôt à chaque fois indiqué par Italcer, hors TVA.
- Les prix des emballages sont indiqués dans la liste de prix correspondante et varient en fonction des différents types d'emballages.

4. LIVRAISON

- Les délais de livraison convenus avec Italcer doivent être considérés comme purement indicatifs et non contraignants pour Italcer. Les éventuels retards de livraison ne donnent jamais à l'Acheteur le droit de résilier le contrat, ni de réclamer la réparation des dommages directs ou indirects, toute exception étant exclue.
- Italcer se réserve le droit d'effectuer des livraisons partielles raisonnables.
- La marchandise est considérée comme achetée par l'Acheteur EXW (Incoterms 2020) à l'entrepôt indiqué par Italcer à chaque fois. La marchandise voyage toujours aux risques de l'Acheteur, même si le prix est franco-destination.
- L'Acheteur est tenu de retirer les Produits dans un délai de 2 (deux) jours ouvrables à compter de la date « marchandise prête » indiquée dans la communication envoyée par Italcer. Si 60 (soixante) jours se sont écoulés à compter de la date indiquée comme « marchandise prête » sans que l'Acheteur ne les ait retirés, le contrat de vente sera considéré comme résilié de plein droit conformément à l'art. 1456 cc.

Par ailleurs, Italcer se réserve le droit d'annuler la commande et de facturer à l'Acheteur :

- pour les Produits standards : un montant au titre des frais de traitement et de gestion, compris entre un minimum de 20 % et un maximum de 50 % de la valeur des Produits ;
- pour les Produits sur mesure : 100 % de la valeur de vente des Produits, en plus des frais de manutention et d'élimination.

- Lors de la réception du matériel, l'Acheteur doit vérifier soigneusement : (i) que le nombre de colis livrés est cohérent avec celui commandé et indiqué sur les documents de transport ; (ii) l'état physique des colis, en vérifiant qu'ils n'ont pas été altérés et/ou endommagés ; (iii) les défauts de la marchandise immédiatement visibles lors de la livraison. En cas d'anomalies/défauts, la marchandise devra être marquée comme « acceptée avec réserve » en inscrivant la raison directement sur le document de livraison. Dans les 24 (vingt-quatre) heures suivant la livraison, l'Acheteur devra également notifier par écrit à Italcer, à l'adresse électronique claim@gruppoitalcer.it, les anomalies et/ou les défauts constatés. Italcer n'acceptera aucune objection concernant ce qui précède si elle n'est pas mentionnée sur le bon de livraison et communiquée dans les conditions susmentionnées.

5. PAIEMENT et RÉSERVE DE PROPRIÉTÉ

- Les paiements sont effectués en faveur d'Italcer, selon les modalités convenues et indiquées dans la facture. Les délais de paiement sont impératifs et leur non-respect entraîne l'application, sur la somme due, d'intérêts de retard au taux prévu et établi par le décret législatif n° 231 de 2002, sans qu'il soit nécessaire de procéder à une mise en demeure formelle.
- En cas de retard dans le paiement total ou même partiel d'une facture, Italcer, sans préjudice de tous ses autres droits, a le droit de suspendre les livraisons ultérieures, même si celles-ci étaient dues dans le cadre d'autres contrats, et d'exiger le paiement immédiat et intégral de tous les Produits commandés, ou de le faire garantir d'une autre manière.
- Il est expressément convenu que la marchandise livrée reste la propriété d'Italcer jusqu'au paiement intégral du prix d'achat par l'Acheteur. Le défaut de paiement de l'une des échéances pourra entraîner de plein droit, sans formalité ni préavis, la récupération de la marchandise par Italcer et l'Acheteur sera tenu de la restituer sur le champ. En cas de saisie ou de toute autre intervention de tiers sur la marchandise vendue, l'Acheteur notifiera auxdits tiers l'existence de la présente clause de réserve de propriété et en informera promptement Italcer afin de permettre la protection de ses droits.

6. RÉCLAMATIONS

- Aucune réclamation ne sera acceptée pour des vices évidents ou vérifiables avec diligence dans les matériaux déjà posés.
- Les vices cachés doivent être notifiés à Italcer par écrit (claim@gruppoitalcer.it) dans les 8 jours suivant leur découverte et, en tout état de cause, au plus tard 24 (vingt-quatre) mois après la livraison.
- Sans préjudice du précédent point 4 e, les réclamations pour vices et défauts des Produits doivent contenir :
 - Les données du Produit et le numéro de lot ;
 - les détails et l'explication du défaut allégué ;
 - une documentation photographique adéquate.

- En cas de Produit défectueux, Italcer garantit uniquement le remplacement des Produits non conformes à la commande, à l'exclusion expresse de la réparation de tous les dommages, pécuniaires ou autres, subis directement ou indirectement.
- Toute réclamation ou contestation n'implique pas la suspension ou le refus de payer les factures. Le paiement devra être effectué régulièrement et intégralement dans les délais convenus.
- Nous n'acceptons pas des retours de marchandises s'ils ne sont pas autorisés par écrit par d'Italcer.

7. JURIDICTION COMPÉTENTE ET DROIT APPLICABLE

Pour tout litige, le tribunal compétent sera celui de Reggio Emilia (Italie) et la loi italienne sera applicable. Toutefois, Italcer se réserve le droit d'agir devant le tribunal compétent du siège social de l'Acheteur pour les actions visant à recouvrer des créances. Dans ce cas, c'est la loi locale qui s'applique.

Les présentes conditions générales sont rédigées en plusieurs langues. En cas de divergence entre les différents textes, la langue italienne prévaut.

DE_Allgemeine Verkaufsbedingungen

Italcer S.p.A. SB („**Italcer**“) behält sich das Recht vor, die im Katalog („**Katalog**“) und auf der Website (die „**Website**“) www.lafabbrica.it (einschließlich aller über das Internet zum Herunterladen zur Verfügung stehenden Dokumente und Kataloge) enthaltenen Informationen und technischen Merkmale jederzeit zu ändern, die nicht als rechtsverbindlich angesehen werden können. Gewichte, Farben und Größen der verkauften Keramikprodukte (die „**Produkte**“) können Schwankungen unterliegen, die für das jeweilige Herstellungsverfahren des keramischen Materials typisch sind. Farben und Aussehen der Produkte sind den tatsächlichen Produkten so ähnlich wie möglich; dies jedoch nur im Rahmen der Möglichkeiten der virtuellen Wiedergabeverfahren. Italcer geht davon aus, dass die in diesem Katalog enthaltenen Informationen und technischen Spezifikationen korrekt und genau sind; das Vorliegen von Materialfehlern kann jedoch nicht ausgeschlossen werden, weshalb der Käufer („**Käufer**“) um Überprüfung der Informationen und technischen Spezifikationen mit den entsprechenden Vertretern / Händlern gebeten wird.

©2024 Italcer S.p.A. SB Alle Rechte vorbehalten. Jede vollständige und/oder teilweise Vervielfältigung des Inhalts dieses Katalogs, sei es in Text- oder Bildform, ist untersagt und wird im Rahmen der gesetzlichen Bestimmungen geahndet.

1. PRODUKTE UND GARANTIE

- Die hohen Brenntemperaturen der Produkte können zu Farbunterschieden und Kaliberschwankungen führen. Abweichungen von den angegebenen Maßen sind daher zulässig und werden vom Käufer akzeptiert, sofern sie jedoch die von der Norm UNI-EN-ISO 14411 vorgesehenen Toleranzgrenzen nicht überschreiten. Davon ausgenommen sind bestimmte Produktkategorien, die von der handwerklichen Verarbeitung mit traditionellen Herstellungsverfahren inspiriert sind, gewollte intrinsische Unregelmäßigkeiten und Größenunterschiede aufweisen und nicht der Anwendung der genannten Norm unterliegen (z. B., aber nicht ausschließlich, die Produkte der „Brick“-Kollektionen).
- Vorbehaltlich dieser Ausnahme garantiert Italcer die Konformität der Produkte mit der derzeit gültigen UNI-EN-ISO 14411-Norm. Die Garantie beschränkt sich ausschließlich auf Materialien erster Wahl. Produkte zweiter und dritter Wahl, Gelegenheitschargen und Produkte, die aus der Produktion genommen wurden, sind als Produkte zu verstehen, die „in dem Zustand verkauft werden, in dem sie sich befinden, ohne die Möglichkeit einer späteren Reklamation“.
- Die Farben der in den Mustern gezeigten Produkte sind als rein indikativ zu betrachten. Etwaige Abweichungen in Farbe, Farbton oder Oberfläche sind durch die Beschaffenheit des Materials selbst, die Merkmale der Produktionszyklen und die verwendeten Rohstoffe begründet. Es wird daher angeraten, die Produkte untereinander zu vermischen, indem man sie aus verschiedenen Kartons nimmt, und sie gemäß den auf der Website veröffentlichten Anweisungen zu verlegen.
- Dekore und Sonderstücke werden in Farbtönen geliefert, die sich vom Grundton unterscheiden.
- Italcer haftet nicht für Schleif- und Polierarbeiten, die vom Kunden nach der Lieferung der Produkte durchgeführt werden.

2. BESTELLUNGEN

- Jede an Italcer vom Käufer, von Vertretern oder Beauftragten abgegebene Bestellung gilt stets als unter dem Vorbehalt der Zustimmung durch die Geschäftsführung von Italcer angenommen.
- Alle, auch mündliche Bestellungen gelten, sofern nicht schriftlich anderslautend vereinbart wurde, stets als von Italcer unter diesen allgemeinen Geschäftsbedingungen angenommen, wobei keine Notwendigkeit besteht, jeweils auf diese hinzuweisen. In Ermangelung präziser schriftlicher Ausnahmen wird davon ausgegangen, dass der Käufer die besonderen und allgemeinen Verkaufsbedingungen vollständig akzeptiert.
- Im Falle höherer Gewalt kann Italcer ganz oder teilweise vom Kaufvertrag zurücktreten.

3. PREISE

- Die Preise gelten für Waren EXW (Incoterms 2020) exkl. MwSt., und zwar ab dem von Italcer jeweils angegebenen Lager.
- Die Verpackungspreise sind in der jeweiligen Preisliste angegeben und variieren je nach den verschiedenen Verpackungsarten.

4. LIEFERUNG

- Die mit Italcer vereinbarten Lieferfristen sind reine Richtwerte und für Italcer nicht bindend. Aus einer möglichen Lieferverzögerung erwächst dem Käufer ausnahmslos keinesfalls das Recht, den Vertrag aufzuheben noch Schadensersatz für direkte oder indirekte Schäden zu verlangen.
- Italcer behält sich das das Recht vor, angemessene Teillieferungen vorzunehmen.
- Die Ware gilt vom Käufer EXW (Incoterms 2020) gekauft, und zwar ab dem von Italcer jeweils angegebenen Lager. Die Waren reisen immer und in jedem Fall auf Risiko und Gefahr des Käufers, auch wenn der Preis frei Bestimmungsort vereinbart wurde.
- Nach Erhalt der Bereitstellungsmitteilung - die Italcer schriftlich übermittelt - ist der Käufer verpflichtet, die Produkte so schnell wie möglich, auf jeden Fall aber innerhalb von 2 (zwei) Kalendertagen nach der vorbezeichneten Mitteilung, abzuholen.

Nach Ablauf von 60 (sechzig) Tagen ab dem als „bereit“ angegebenen Datum, ohne dass der Käufer die Ware abgeholt hat, gilt der Kaufvertrag gemäß Artikel 1456 des

italienischen Zivilgesetzbuches automatisch als aufgelöst.

Italcer behält sich außerdem das Recht vor, die Bestellung zu stornieren und dem Käufer in Rechnung zu stellen:

- für Standardprodukte einen Betrag für Bearbeitungs- und Verwaltungskosten, der zwischen mindestens 20% und höchstens 50% des Warenwertes liegt;
- für Sonderanfertigungen 100% des Verkaufswerts der Ware, zuzüglich der Bearbeitungs- und Entsorgungskosten.

- Nach Erhalt des Materials ist der Käufer angehalten, sorgfältig zu überprüfen: (i) die Übereinstimmung der Anzahl der gelieferten Packstücke mit der bestellten und auf dem Lieferschein angegebenen Menge; (ii) den Zustand der Packstücke hinsichtlich Manipulation und/oder Beschädigung; (iii) das Vorliegen etwaiger Mängel an den Waren, die unmittelbar bei der Lieferung sichtbar sind. Bei Unregelmäßigkeiten / Mängeln ist der Vermerk „unter Vorbehalt angenommen“ anzubringen und der Grund direkt auf dem Lieferschein einzutragen. Der Käufer ist zudem angehalten, Italcer binnen 24 (vierundzwanzig) Stunden nach der Lieferung über die festgestellten Unregelmäßigkeiten und/oder Mängel auch schriftlich unter der E-Mail-Adresse claim@gruppoitalcer.it zu informieren. Italcer akzeptiert etwaige Beanstandungen in Bezug auf Vorstehendes nur, wenn diese auf dem Lieferschein vermerkt und innerhalb der oben genannten Fristen mitgeteilt werden.

5. BEZAHLUNG und EIGENTUMSVORBEHALT

- Die Zahlungen müssen gemäß den vereinbarten und in der Rechnung angegebene Bedingungen zu Gunsten von Italcer erfolgen. Die Zahlungsfristen sind zwingend und ihre Nichteinhaltung hat zur Folge, dass, ohne Erfordernis einer förmlichen Inverzugsetzung, auf den geschuldeten Betrag Verzugszinsen in Höhe des in der Gesetzesverordnung Nr. 231/2002 vorgesehenen und festgelegten Satzes erhoben werden.
- Im Falle eines Verzugs bei der vollständigen oder auch nur teilweisen Begleichung einer Rechnung ist Italcer, unbeschadet aller sonstigen Ansprüche, berechtigt, weitere Lieferungen auszusetzen, auch wenn diese im Zusammenhang mit anderen Verträgen auszuführen sind, und außerdem die sofortige und vollständige Bezahlung aller bestellten Produkte zu verlangen oder anderweitig sicherstellen zu lassen.
- Es wird ausdrücklich vereinbart, dass die gelieferten Waren bis zur vollständigen Bezahlung des Kaufpreises durch den Käufer Eigentum von Italcer bleiben. Die Nichtbezahlung einer der Raten kann automatisch und ohne Formalitäten oder Vorankündigung zur Rückholung der Ware durch Italcer führen, und der Käufer ist verpflichtet, diese Ware unverzüglich herauszugeben. Im Falle einer Pfändung oder sonstiger Eingriffe Dritter in die verkaufte Ware hat der Käufer diese Dritten auf das Bestehen dieses Eigentumsvorbehalts hinzuweisen und Italcer unverzüglich zu informieren, um Italcer die Wahrung ihrer Rechte zu ermöglichen.

6. REKLAMATIONEN

- Reklamationen wegen offensichtlicher oder unter Anwendung qualifizierter Sorgfalt feststellbarer Mängel an bereits verlegten Materialien werden nicht akzeptiert.
- Versteckte Mängel müssen Italcer binnen 8 Tagen nach ihrer Feststellung und in jedem Fall spätestens 24 (vierundzwanzig) Monate nach der Lieferung schriftlich mitgeteilt werden (claim@gruppoitalcer.it).
- Unbeschadet der obigen Ziffer 4 e, müssen Ansprüche wegen Mängeln an den Produkten enthalten:
 - Produktdaten und Chargennummer;
 - Details und ausführliche Beschreibung des mutmaßlichen Fehlers;
 - eine angemessene fotografische Dokumentation.
- Im Falle eines defekten oder fehlerhaften Produkts garantiert Italcer nur den Ersatz der Produkte, die nicht der Bestellung entsprechen, und zwar unter ausdrücklichem Ausschluss der Entschädigung für alle direkt oder indirekt erlittenen Vermögens- oder sonstigen Schäden.
- Eine Reklamation oder Beanstandung führt nicht zur Aussetzung und Verweigerung der Zahlung von Rechnungen. Die Zahlungen sind regelmäßig und vollständig innerhalb der vereinbarten Fristen zu leisten.
- Rücksendungen von Waren werden nicht angenommen, es sei denn, sie wurden von Italcer schriftlich genehmigt.

7. GERICHTSSTAND UND ANWENDBARES RECHT

Für alle Streitigkeiten ist der Gerichtsstand Reggio Emilia (Italien) zuständig, und es gilt italienisches Recht. Italcer behält sich jedoch das Recht vor, bei Klagen zur Forderungsbeitreibung das zuständige Gericht am Sitz des Käufers anzurufen. In diesem Fall gilt das örtlich anwendbare Recht.

Diese allgemeinen Bedingungen sind in mehreren Sprachen abgefasst. Bei Unstimmigkeiten zwischen den verschiedenen Texten ist die Fassung in italienischer Sprache maßgebend.

Note generiche sui prodotti

Italcer S.p.A. SB si riserva di apportare, senza alcun preavviso, le modifiche che riterrà più opportune al fine di migliorare il prodotto.

Quanto riportato è da considerarsi indicativo e non esaustivo in riferimento ai colori e alle caratteristiche estetiche dei prodotti.

EN_ *General information on the products*

Italcer S.p.A. SB reserves the right to make any changes it deems fit in order to improve the product, without prior notice.

All images are provided for illustrative purposes only and other colours and aesthetic features are available.

FR_ *Notes generales sur les produits*

Italcer S.p.A. SB se réserve le droit d’apporter, sans préavis, les modifications qu’elle jugera opportunes afin d’améliorer le produit.

Les informations ci-dessus sont fournies à titre indicatif et elles ne sont pas contraignantes en ce qui concerne les couleurs et les caractéristiques esthétiques des produits.

DE_ *Allgemeine angaben zu den produkten*

Die Firma Italcer S.p.A. SB behält sich vor, ohne jegliche vorherige Ankündigung jene Änderungen vorzunehmen, die sie zur Verbesserung des Produktes für angebracht hält.

Die Angaben sind bezüglich der Farben und ästhetischen Eigenschaften der Produkte als Richtwerte und nicht als vollständig anzusehen.

Colori e strutture

Le cromie, le strutture e le grafiche delle piastrelle riprodotte nelle immagini del catalogo potrebbero non corrispondere fedelmente al prodotto industriale.

EN_ The colours, structures, and patterns of the tiles illustrated in the catalogue might not correspond exactly to the actual product.

FR_ Les tonalités, les structures et les graphismes des carreaux reproduits sur les images du catalogue pourraient ne pas correspondre fidèlement au produit industriel.

DE_ Es ist möglich, dass die im Katalog abgebildeten Fliesen in Bezug auf Farbton, Struktur und Grafik vom Industrieerzeugnis abweichen.

Decorazioni

- ATTENZIONE: Per particolari installazioni potrebbero essere necessari articoli ed accessori specifici non presenti in questo catalogo. Per queste esigenze prego riferirsi direttamente al referente commerciale LA FABBRICA AVA.**

EN_ N.B. Particular items and accessories not listed in this catalogue may be required for certain laying methods. For these needs, please contact the LA FABBRICA AVA sale sales directly.**FR_** ATTENTION: Pour les installations particulières, certains articles et accessoires particuliers qui ne sont pas indiqués dans ce catalogue pourraient être nécessaires. Dans ces cas-là, nous vous prions de vous référer directement à la référence commerciale LA FABBRICA AVA.**DE_** ACHTUNG: Für besondere Installationen können besondere Artikel oder Sonderzubehör notwendig sein, die nicht im vorliegenden Katalog aufgeführt sind. Wenden Sie sich bitte in diesen Fällen direkt an den Vertrieb von LA FABBRICA AVA.

- Tutti i decori si abbinano al fondo ma possono essere di tonalità diverse.**

EN_ All decorations match the base but may be of a different tone.**FR_** Tous les décors sont assortis au fond, mais les tonalités peuvent être différentes.**DE_** Alle Dekore passen zum Untergrund, können jedoch unterschiedliche Farbtöne aufweisen.

- Si consiglia fortemente di pulire bene la superficie delle piastrelle strutturate immediatamente dopo aver fugato il pavimento. questa operazione eviterà al materiale usato per la fuga di solidificarsi all'interno delle cavità presenti nella superficie della piastrella.**

EN_ We strongly recommended you thoroughly clean the surface of textured floor tiles immediately after filling the joints. This will prevent the filler solidifying in the cavities found in the tiles’ surface.**FR_** Il est vivement recommandé de bien nettoyer la surface des carreaux structurés, immédiatement après le jointoyage. Cette opération empêchera le matériel utilisé pour le jointoyage de se solidifier à l’intérieur des cavités présentes à la surface des carreaux.**DE_** Es wird dringend geraten, die Oberfläche der strukturierten Fliesen sofort nach dem Verfugen des Bodenbelags gut zu reinigen. Dieser Vorgang verhindert, dass das zum Verfugen verwendete Material innerhalb der in der Fliesenoberfläche vorhandenen Hohlräume aushärten kann.

- Decorazioni con vetri e graniglie. Le decorazioni mediante l'applicazione dei vetri e delle graniglie vetrose sulle piastrelle ceramiche possono presentare delle irregolarità nella distribuzione di dette graniglie, questo non pregiudica l'effetto estetico del prodotto, ma anzi ne esalta le caratteristiche.**

EN_ Decors with glass and glass-grit. The decors produced by the application of glass and glass grit on ceramic tiles may have an irregular distribution when utilising the glass grit. This technique does not compromise the aesthetic effect of the decor and moreover it does enhance its technical features.**FR_** Décors avec pâtes de verre. Les décors fabriqués en appliquant des pâtes de verre sur les carreaux céramiques peuvent résender une distribution irrégulière de ces pâtes; ceci n'empêche pas l'effet esthétique du décor, mais au contraire améliore ses caractéristiques.**DE_** Dekore mit Buntglas und Spliteinsteerungen. Diese serie ist dekoriert mit buntglas und spliteinsteerungen. Bei der Anwendung dieser körnigen Glas Split Anteile, können optische, so wie strukturelle Unregelmäßigkeiten bei der Verteilung in der Oberfläche auftreten. Dies gilt als gewünschter Effekt, zur zusätzlichen ästhetische Aufwertung des Produkts.

- Per un risultato ottimale si consiglia di utilizzare durante la posa i cunei.**

EN_ For a perfect result, we recommend you use wedges during laying.**FR_** Nous conseillons d'utiliser les coins durant la pose pour un résultat optimal.**DE_** Für ein ausgezeichnetes Ergebnis wird empfohlen, bei der Verlegung die Keile zu verwenden.

- Si consiglia di mantenere una fuga di 2 mm per la posa in monoformato degli articoli rettificati. Si consiglia di mantenere una fuga di 3 mm per la posa in multiformato (da 2 formati e oltre) degli articoli rettificati. Si consiglia di mantenere una fuga di 4 mm per la posa degli articoli con bordi non rettificati.**

EN_ If you are laying same sized straightened-edged tiles, we recommend you keep a 2 mm joint. If you are laying different sized straightened-edged tiles (two or more sizes) together, we recommend you keep a 3 mm joint. In the case of non-straightened-edged tiles, we recommend you keep a 4 mm joint.**FR_** On conseille de préserver un joint de 2 mm pour la pose en mon format des articles rectifiés. On conseille de préserver un joint de 3 mm pour la pose en multiformat (de 2 formats et plus) des articles rectifiés. On conseille de préserver un joint de 4 mm pour la pose des articles présentant des bords non rectifiés.**DE_** Es wird geraten, eine Fuge von 2 mm bei der Verlegung der geschliffenen Artikel im Einzelformat einzuhalten. Es wird geraten, eine Fuge von 3 mm bei der Verlegung der geschliffenen Artikel als Multiformat (2 Formate und mehr) einzuhalten. Es wird geraten, eine Fuge von 4 mm bei der Verlegung der Artikel mit ungeschliffenen Rändern einzuhalten.

- Per il gradino non si garantisce la stessa tonalità del fondo.**

EN_ We cannot guarantee that the shade of the stair tile will be the same as the background tile.**FR_** Pour la marche, nous ne garantissons pas la même tonalité du fond.**DE_** Für die Stufe wird nicht der gleiche Farbton der Grundfliese garantiert.

- La tonalità del colore della piastrella nelle finiture liscia e strutturata potrebbe essere leggermente dissimile.**

- In caso di posa modulare il grado di stonalizzazione del pavimento potrebbe aumentare rispetto ad una posa monoformato.**

- On pattern sizes floors the shading may result being more intense than on a single format floor.**

Consulta il sito www.lafabbrica.it per vedere gli ultimi aggiornamenti.

EN_ Check out our website at www.lafabbrica.it for the latest updates.

FR_ Consultez le site www.lafabbrica.it pour connaître les dernières mises à jour.

DE_ Auf der Website www.lafabbrica.it finden Sie die neuesten Informationen.

AD: **MARKETING LA FABBRICA AVA**

PRINT: **OFFICINE GRAFICHE STAGED S.R.L.**

EDITION I - JANUARY 2025

Italcer S.p.A. SB si riserva di apportare, senza alcun preavviso, le modifiche che riterrà più opportune al fine di migliorare il prodotto.

Quanto riportato è da considerarsi indicativo e non esaustivo in riferimento ai colori e alle caratteristiche estetiche dei prodotti.

EN_ Italcer S.p.A. SB reserves the right to make any changes it deems fit in order to improve the product, without prior notice.

All images are provided for illustrative purposes only and other colours and aesthetic features are available.

FR_ Italcer S.p.A. SB se réserve le droit d'apporter, sans préavis, les modifications qu'elle jugera opportunes afin d'améliorer le produit.

Les informations ci-dessus sont fournies à titre indicatif et elles ne sont pas contraignantes en ce qui concerne les couleurs et les caractéristiques esthétiques des produits.

DE_ Die Firma Italcer S.p.A. SB behält sich vor, ohne jegliche vorherige Ankündigung jene Änderungen vorzunehmen, die sie zur Verbesserung des Produktes für angebracht hält.

Die Angaben sind bezüglich der Farben und ästhetischen Eigenschaften der Produkte als Richtwerte und nicht als vollständig anzusehen.



Italcer S.p.A. SB | P.IVA 00142060359
Sales Department, Showroom
Via Emilia Ponente 2070 - 48014 Castel Bolognese (RA) Italy
Tel.: +39 0546 659 911 - Email: info@lafabbrica.it
www.lafabbrica.it